

139-2051

FLC260-TW LED

we-ef



Description

IP66. Classe I. Classe II sur demande. IK07. Corps en fonte d'aluminium. Visserie inox avec traitement PCS. Protection contre la corrosion 5CE. Joint silicone. Verre de sécurité. DALI interface.

Poids	18.50 kg
Distribution de la lumière	faisceau symétrique, médium [M]
Source lumineuse	LED-36/132W - 2200-6000 K
IRC	80
Alimentation électrique	ballast électronique
LEDs	36
Rated input power	152 W

Flux lumineux nominal (lm)

LED Lumen	420
Total Lumen	15120
Tj	85

Rated lumens (lm)

LED Lumen	338.2
Total Lumen	12174
Ta	25

WE-EF Switzerland AG

Himmelrichstrasse 6, 6003 Luzern - Téléphone: +41 22 752 49 94

info.switzerland@we-ef.com - https://we-ef.com/ch_fr

Sous réserve de modifications techniques et d'erreurs. - Généré le 23/11/2024

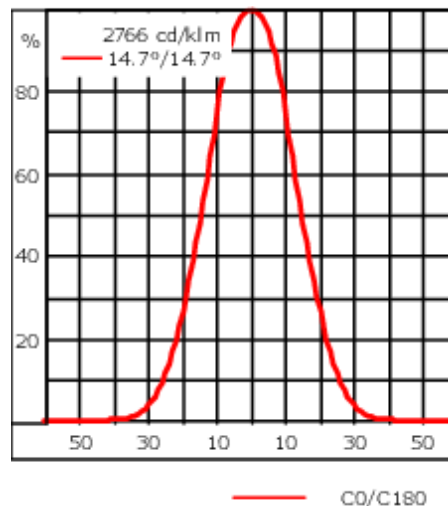
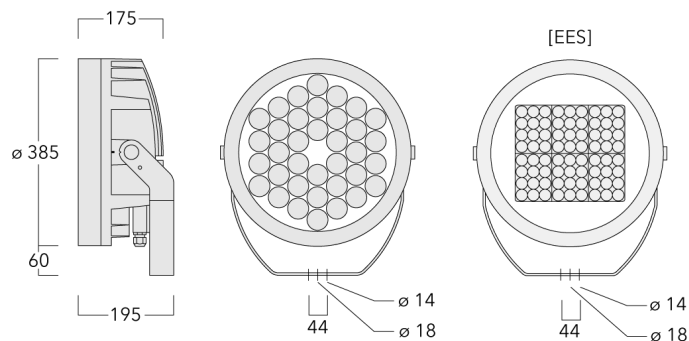

Spécifications

Description du matériel

Corps	Corps en fonte d'aluminium, visserie inox avec traitement PCS
Lentille	Verre de sécurité
Couleurs	<div style="display: flex; align-items: center; gap: 10px;"> <div style="width: 20px; height: 15px; background-color: black; margin-right: 5px;"></div> RAL9004 Noir de sécurité <div style="width: 20px; height: 15px; background-color: #808080; margin-right: 5px;"></div> RAL9007 Aluminium gris <div style="width: 20px; height: 15px; background-color: #404040; margin-right: 5px;"></div> RAL7016 Gris anthracite <div style="width: 20px; height: 15px; background-color: #e0e0e0; margin-right: 5px;"></div> RAL9016 Blanc signalisation </div>
Joint	Joint silicone CCG®
Visserie	PCS Inox avec recouvrement polymère
IP	IP66
IK	IK07
Protection contre la corrosion	5CE
Surface exposée au vent	0.116 m ²

Description électrique

Driver	DALI
--------	------

Informations complémentaires

Durée de vie	Ta=25° L90B10 > 90000h
Classe d'efficacité énergétique	E

Accessoires Optiques**Lentille ovalisante**

Description	Référence	C1
IO-180-FLC260-LED	139-1861	332

**Canon anti-éblouissement**

Description	Référence	A	C1
ET-FLC260-LED	139-1865	222	393



Visière

Description	Référence	A	C1
ES-FLC260-LED	139-1864	222	393

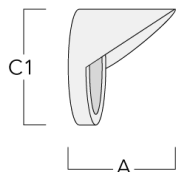

Accessoires d'installation

Collier pour mâts TS

Description	Référence	D1	Poids (kg)	D
TS1-2/M12 collier simple pour tube (Ø 114-133)	147-0544	114-133	1.70	114-133

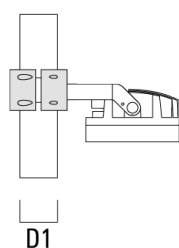
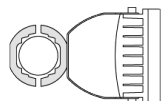

TS2-2/M12 collier double pour tube (Ø 76-89)	147-0545	76-89	1.40	76-89
---	----------	-------	------	-------

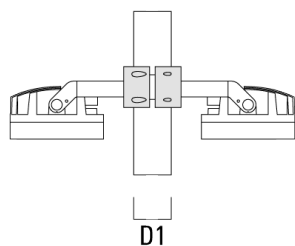
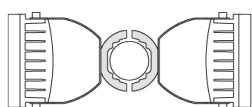

Traverse pour mâts

Description	Référence	C1	D x L1	Poids (kg)	D x S
TA1 traverse simple (Ø 76 x 200)	147-0023	130	76 x 200	1.90	76 x 200

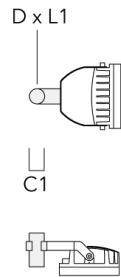

Collier pour mâts PC

Description	Référence	D1	Poids (kg)
PC2 76-89/60 collier double pour tube (Ø 76-89)	139-2703	76-89	1.00

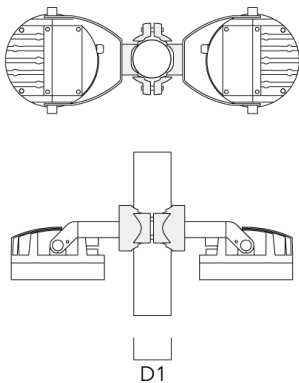

FLC260-TW LED

Description	Référence	D1	Poids (kg)
PC1 76-89/60 collier simple (Ø 76-89)	139-2702	76-89	1.00



PC2 102-114/60 collier double pour tube (Ø 102-114)	139-2707	102-114	1.20
---	----------	---------	------

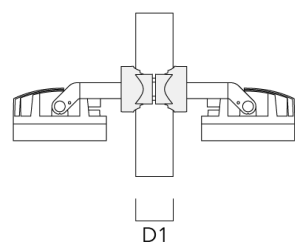
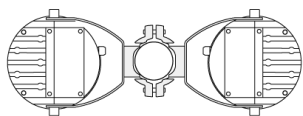

FLC260-TW LED

Description	Référence	D1	Poids (kg)
PC1 102-114/60 collier simple (Ø 102-114)	139-2706	102-114	1.20



PC2 114-133/60 collier double pour tube (Ø 114-133)	139-2709	114-133	1.40
---	----------	---------	------

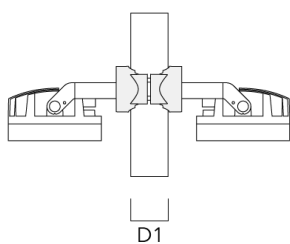
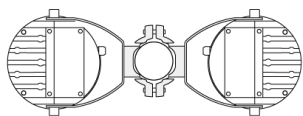

FLC260-TW LED

Description	Référence	D1	Poids (kg)
PC1 114-133/60 collier simple (Ø 114-133)	139-2708	114-133	1.40

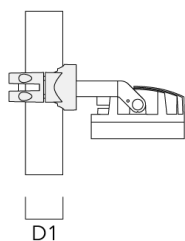
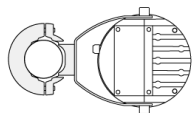

PC2 82-109/60 collier double pour tube (Ø 82-109)	139-2705	82-109	1.10
---	----------	--------	------

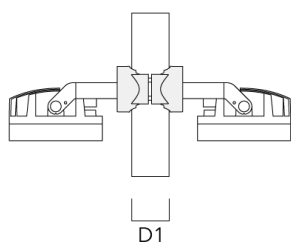
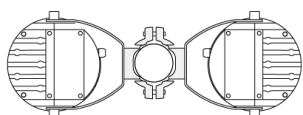

Control**DMX Wireless Repeater**

Description	Référence
DMX Wireless Repeater	400-0477



DMX Wireless Transceiver

Description	Référence
DMX Wireless Transceiver	400-0476

