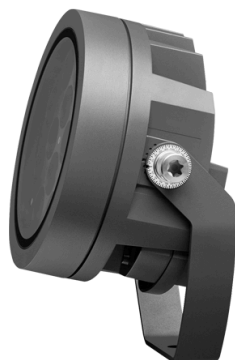

FLC230-TW LED

**Description**

Tunable white projector. IP66. Class I. IK07. Marine-grade, die-cast aluminium alloy. 5CE superior corrosion protection including PCS hardware. Safety glass lens. Silicone CCG® Controlled Compression Gasket. Two cable glands.

Integral EC electronic converter in thermally-separated compartment. Advanced thermal management protects LEDs while optimising lumens output. CAD-optimised optics for superior illumination and glare control. OLC® One LED Concept. LED circuit board with Tunable White Technology.

DALI Interface . For other control interface options to suit specific project requirements, contact WE-EF.

Weight	7.70 kg
Light distribution	linear spread, narrow beam [E]
Light source	LED-12/44W - 2200-6000 K
CRI	80
Power supply	EC
LEDs	12
Rated input power	51 W

Nominal Lumen (lm)

LED Lumen	420
Total Lumen	5040
Tj	85

Rated lumens (lm)

LED Lumen	319.6
Total Lumen	3835.7
Ta	25

FLC230-TW LED

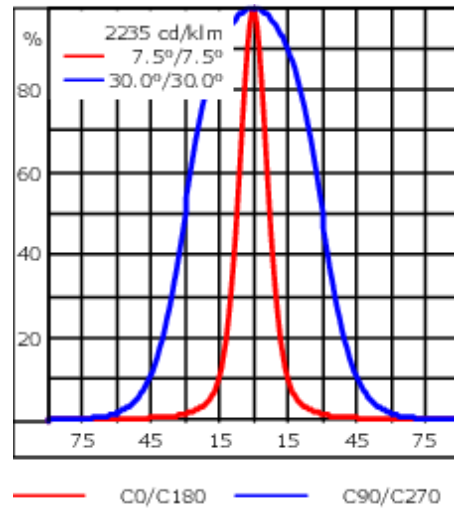
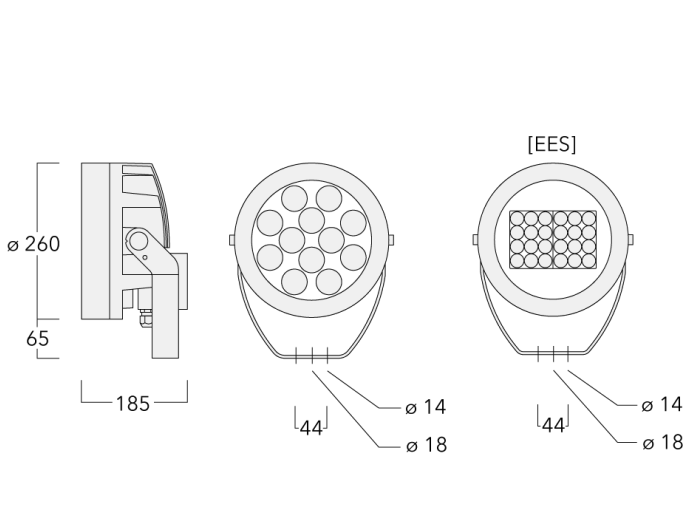

Specifications

Material description

Body	Marine-grade, die-cast aluminium alloy
Lens	Safety glass lens
Colours	<div style="display: flex; align-items: center;"> <div style="width: 20px; height: 15px; background-color: black; margin-right: 5px;"></div> RAL9004 Signal black </div> <div style="display: flex; align-items: center; margin-top: 5px;"> <div style="width: 20px; height: 15px; background-color: grey; margin-right: 5px;"></div> RAL9007 Grey aluminium </div> <div style="display: flex; align-items: center; margin-top: 5px;"> <div style="width: 20px; height: 15px; background-color: darkgrey; margin-right: 5px;"></div> RAL7016 Anthracite grey </div> <div style="display: flex; align-items: center; margin-top: 5px;"> <div style="width: 20px; height: 15px; background-color: white; margin-right: 5px;"></div> RAL9016 Traffic white </div>
Gasket	Silicone CCG® Controlled Compression Gasket
Fasteners	PCS Polymer Coated Stainless Steel Hardware
Ingress protection	IP66
Impact resistance	IK07
Corrosion resistance	5CE
Windage	0.054 m ²

Electrical description

Driver / Ballast	DALI
------------------	------

Additional information

Lifetime	T _a =25° L90B10 > 90000h
----------	-------------------------------------

Mounting Accessories

Floodlight mounting bracket TA

Description	Part ID	A	C1	D × L1	Weight (kg)	D × S
TA2-L Mounting bracket, double (Ø 76 x 200)	147-0105	±90°	420	76 x 200	16.10	76 x 200

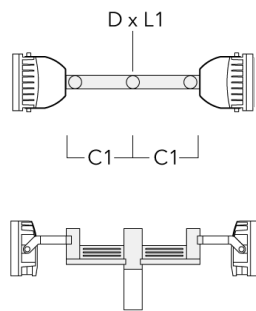

Planted root

Description	Part ID	D1	D2	D3	D4	H1	H2	M1	T1	T2	Weight (kg)
Planted root ESV4	300-0461-AP	150	130	60	89	400	350	8	200	50 x 100	3.85

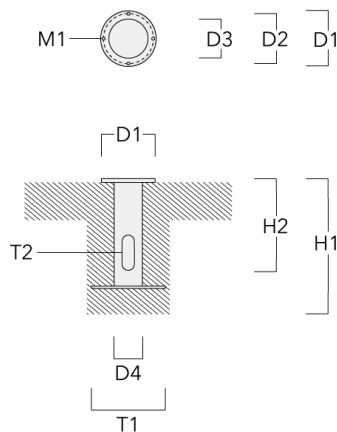

FLC230-TW LED

Spigot cap

Description	Part ID	D1	Weight (kg)	D
KF1-60/M16	310-9120	60x100	2.00	60 x 100

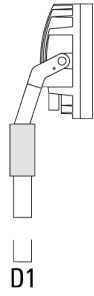

KF1-76/M16	310-9121	76 x 100	2.00	76 x 100
------------	----------	----------	------	----------

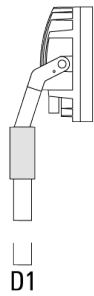

FLC230-TW LED

Pole clamp SP - Tiltable

Description	Part ID	D1	Weight (kg)	D
Pole clamp SP1-M16, single (Ø 76-89)	146-0242	76-89	1.30	76-89

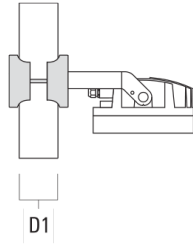

Pole clamp SP2-M16, double (Ø 76-89)	146-0244	76-89	1.50	
--------------------------------------	----------	-------	------	--

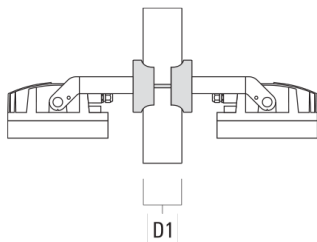

FLC230-TW LED

Description	Part ID	D1	Weight (kg)	D
Pole clamp SP1-M16, single (Ø 38-60)	146-0241	38-60	1.30	

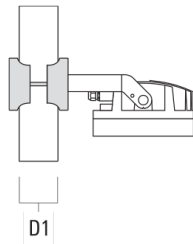

Pole clamp SP2-M16, double (Ø 38-60)	146-0243	38-60	1.50	
--------------------------------------	----------	-------	------	--

Junction box

Description	Part ID	Additional information	A	B	C1	Weight (kg)
Junction box JB20 - Cable side entries	310-9013	Junction boxes are made from marine-grade, die-cast aluminium alloy. IK10. IP66. For side entries and suitable to be used with cable glands.	180	143	51	1.02

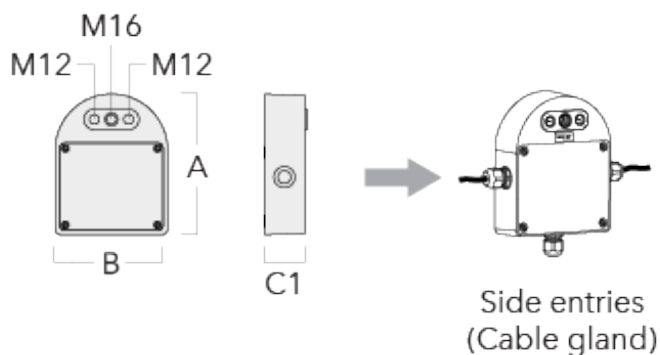

FLC230-TW LED

Description	Part ID	Additional information	A	B	C1	Weight (kg)
Junction box JB20 - Conduit side entries	310-9014	Junction boxes are made from marine-grade, die-cast aluminium alloy. IK10. IP66. For side entries and suitable to be used with conduits.	180	143	51	1.02

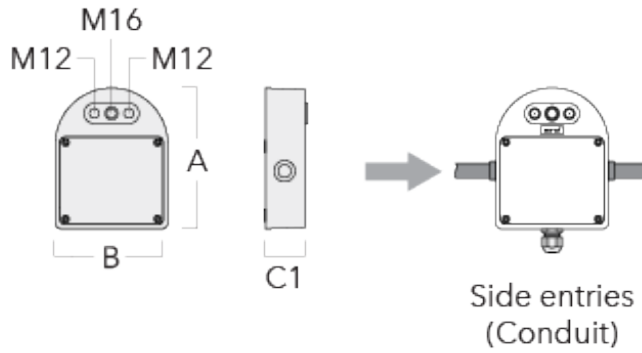

Junction box JB20 - Wall entries	310-9018	Junction boxes are made from marine-grade, die-cast aluminium alloy. IK10. IP66. For wall entries.	180	143	51	1.02
----------------------------------	----------	--	-----	-----	----	------

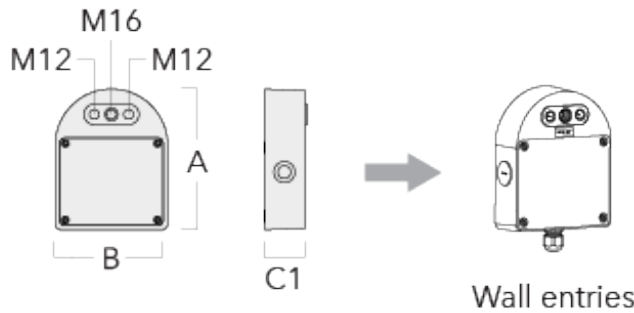

FLC230-TW LED

Pole clamp PC - Rotatable

Description	Part ID	D1	Weight (kg)
PC2 76-89/60 Pole clamp, double (Ø 76-89)	139-2703	76-89	1.00

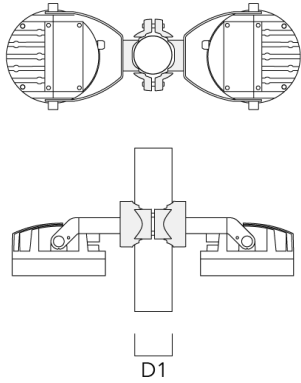

PC1 76-89/60 Pole clamp, single (Ø 76-89)	139-2702	76-89	1.00
---	----------	-------	------

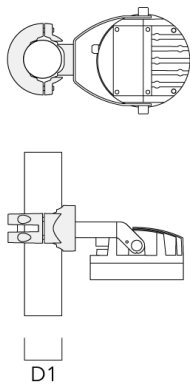

FLC230-TW LED

Description	Part ID	D1	Weight (kg)
PC2 102-114/60 Pole clamp, double (Ø 102-114)	139-2707	102-114	1.20



PC1 102-114/60 Pole clamp, single (Ø 102-114)	139-2706	102-114	1.20
--	----------	---------	------

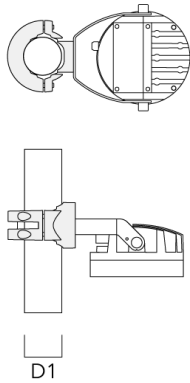

FLC230-TW LED

Description	Part ID	D1	Weight (kg)
PC2 114-133/60 Pole clamp, double (Ø 114-133)	139-2709	114-133	1.40



PC1 114-133/60 Pole clamp, single (Ø 114-133)	139-2708	114-133	1.40
--	----------	---------	------

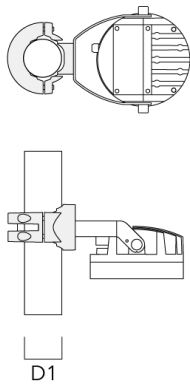

FLC230-TW LED

Description	Part ID	D1	Weight (kg)
PC2 82-109/60 Pole camp, double (Ø 82-109)	139-2705	82-109	1.10



PC1 82-109/60 Pole camp, single (Ø 82-109)	139-2704	82-109	1.10
--	----------	--------	------



FLC230-TW LED

Optical Accessories

Linear spread lens

Description	Part ID	C1
Linear spread lens IO-180	139-1849	199

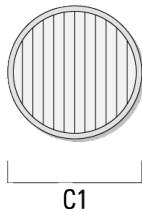

Flood lens

Description	Part ID	C1
IO-360-FLC230-TW	139-1850	199

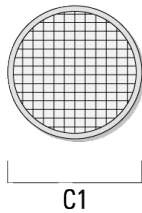

FLC230-TW LED

Glare shield

Description	Part ID	A	C1
Glare shield ES	139-1852	159	266

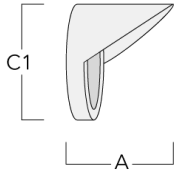

Snoot

Description	Part ID	A	C1
Snoot ET	139-1853	160	266

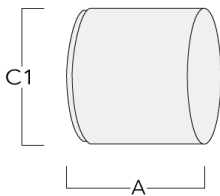

FLC230-TW LED

Wallwash lens

Description	Part ID	C1
Wallwash lens IO-20	139-1848-AP	199

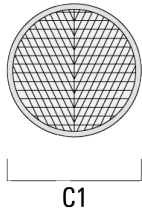

Honeycomb louvre

Description	Part ID	C1
Honeycomb louvre IW	139-1851	199

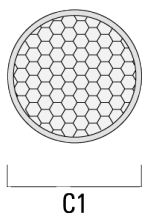

Control

DMX Wireless Repeater

Description	Part ID
DMX Wireless Repeater	400-0477



DMX Wireless Transceiver

Description	Part ID
DMX Wireless Transceiver	400-0476



139-2135+139-1849

we-ef

FLC230-TW LED

R2C Ready to Connect

Description	Part ID
R2C Ready to Connect (top)	430-0019

WE-EF LIGHTING (Thailand) Co., Ltd.

57 Moo 5, Kingkaew Rd., Bangplee, 10540 Samutprakarn - Phone: +66 2 738 96 20 - Fax: +66 2 738 96 29

<https://we-ef.com/asia>

Subject to technical changes and errors. - Generated on 23/11/2024