



### Description

Tunable White. IP66, Class I. Class II on request. IK07. Marine-grade, die-cast aluminium alloy. 5CE superior corrosion protection including PCS hardware. Silicone CCG® Controlled Compression Gasket. Safety glass lens. One cable gland. Second gland for through-wiring on request. Integral EC electronic converter, thermally separated. CAD-optimised optics for superior illumination and glare control. OLC® One LED Concept. Factory-installed LED circuit board with Tunable White Technology. DALI Interface.

Weight	18.50 kg
Light distribution	linear spread, narrow beam [E]
Light source	LED-36/132W - 2200-6000 K
CRI	80
Power supply	EC
LEDs	36
Rated input power	152 W
<b>Nominal Lumen (lm)</b>	
LED Lumen	420
Total Lumen	15120
Tj	85
<b>Rated lumens (lm)</b>	
LED Lumen	319.6
Total Lumen	11507.2
Ta	25

## FLC260-TW LED

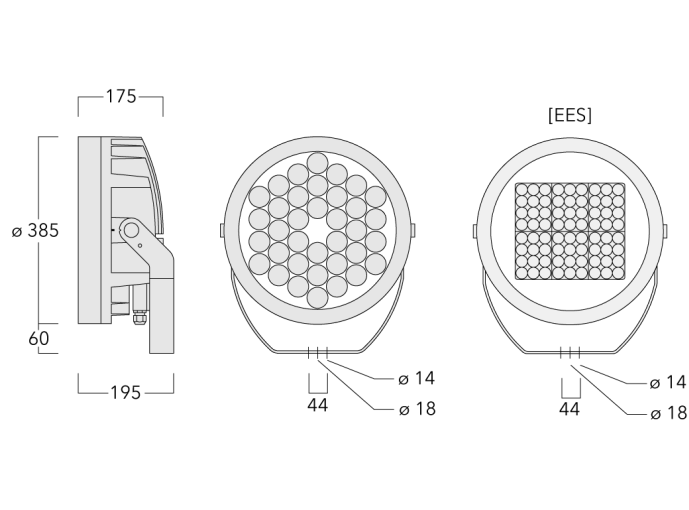

## Specifications

## Material description

Body	Marine-grade, die-cast aluminium alloy
Lens	Safety glass lens
Colours	<div style="display: flex; align-items: center; gap: 10px;"> <div style="width: 20px; height: 15px; background-color: black; margin-right: 5px;"></div> RAL9004 Signal black  <div style="width: 20px; height: 15px; background-color: #cccccc; margin-right: 5px;"></div> RAL9006 White aluminium  <div style="width: 20px; height: 15px; background-color: #808080; margin-right: 5px;"></div> RAL9007 Grey aluminium  <div style="width: 20px; height: 15px; background-color: #333333; margin-right: 5px;"></div> RAL7016 Anthracite grey  <div style="width: 20px; height: 15px; background-color: #e0e0e0; margin-right: 5px;"></div> RAL9016 Traffic white         </div>
Gasket	Silicone CCG® Controlled Compression Gasket
Fasteners	PCS Polymer Coated Stainless Steel Hardware
Ingress protection	IP66
Impact resistance	IK07
Corrosion resistance	5CE
Windage	0.116 m <sup>2</sup>

## Electrical description

Power supply	220-240V / 50-60 Hz
Driver / Ballast	DALI
Power factor	> 0.9
Surge protection	1/2 kV (optional SP10)

## Additional information

Lifetime	Ta=25° L90B10 > 90000h
Energy efficiency class	E (Light source)

## Fagerhult Lighting Ltd

33-34 Dolben Street, SE1 0UQ London, United Kingdom

<https://we-ef.com/uk>

Subject to technical changes and errors. - Generated on 27/11/2024

### Optical Accessories

#### Wallwash lens

---

Description	Part ID	C1
IO-20-FLC260-LED	139-1860	332

---

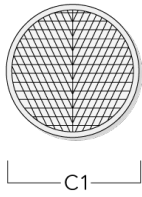

---

#### Linear spread lens

---

Description	Part ID	C1
IO-180-FLC260-LED	139-1861	332

---

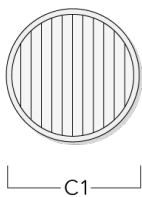

## FLC260-TW LED

## Snoot

Description	Part ID	A	C1
ET-FLC260-LED	139-1865	222	393

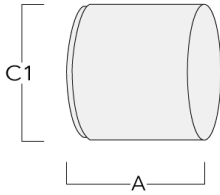

## Glare shield

Description	Part ID	A	C1
ES-FLC260-LED	139-1864	222	393

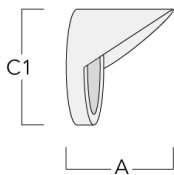

## Mounting Accessories

### Pole clamp TS

Description	Part ID	D1	Weight (kg)	D
TS1-2/M12 Pole clamp, single (Ø 114-133)	147-0544	114-133	1.70	114-133

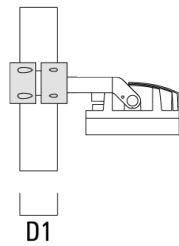
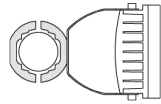

TS2-2/M12 Pole clamp, double (Ø 76-89)	147-0545	76-89	1.40	76-89
----------------------------------------	----------	-------	------	-------

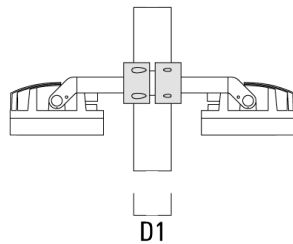
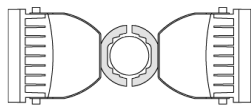

**FLC260-TW LED**

**Floodlight mounting bracket TA**

Description	Part ID	C1	D × L1	Weight (kg)	D × S
TA1 Mounting bracket, single* (Ø 76 x 200)	147-0023	130	76 x 200	1.90	76 x 200

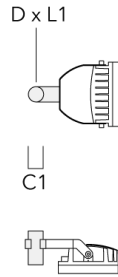

**Pole clamp PC**

Description	Part ID	D1	Weight (kg)
PC2 76-89/60 Pole clamp, double (Ø 76-89)	139-2703	76-89	1.00

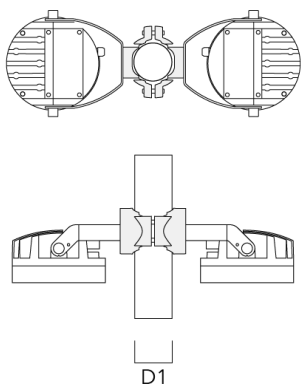

**FLC260-TW LED**

Description	Part ID	D1	Weight (kg)
PC1 76-89/60 Pole clamp, single (Ø 76-89)	139-2702	76-89	1.00

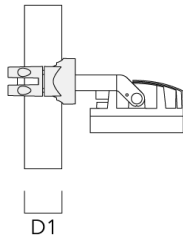
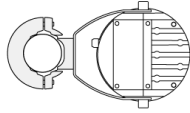

PC2 102-114/60 Pole clamp, double (Ø 102-114)	139-2707	102-114	1.20
-----------------------------------------------	----------	---------	------

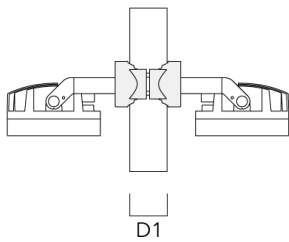
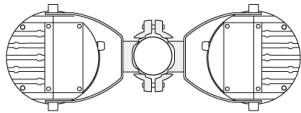

**FLC260-TW LED**

Description	Part ID	D1	Weight (kg)
PC1 102-114/60 Pole clamp, single (Ø 102-114)	139-2706	102-114	1.20

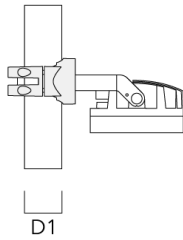
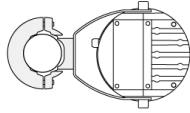

PC2 114-133/60 Pole clamp, double (Ø 114-133)	139-2709	114-133	1.40
--------------------------------------------------	----------	---------	------

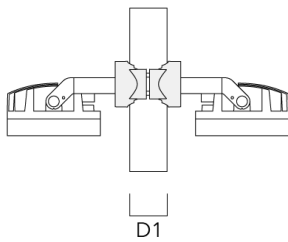
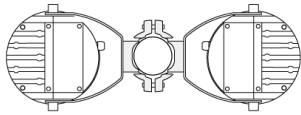



**FLC260-TW LED**

Description	Part ID	D1	Weight (kg)
PC1 114-133/60 Pole clamp, single (Ø 114-133)	139-2708	114-133	1.40

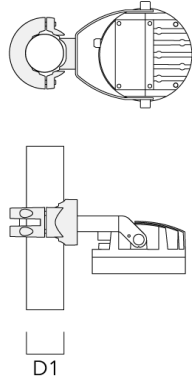

PC2 82-109/60 Pole camp, double (Ø 82-109)	139-2705	82-109	1.10
--------------------------------------------	----------	--------	------

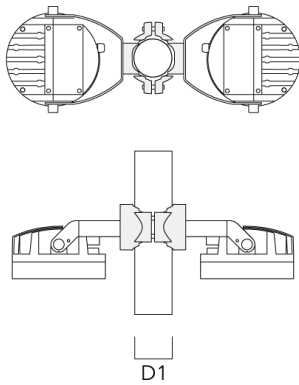

139-2052+139-1861

FLC260-TW LED

**we-ef**

## Control

### DMX Wireless Repeater

---

Description	Part ID
DMX Wireless Repeater	400-0477

---



---

### DMX Wireless Transceiver

---

Description	Part ID
DMX Wireless Transceiver	400-0476

---



---

#### Fagerhult Lighting Ltd

33-34 Dolben Street, SE1 0UQ London, United Kingdom

<https://we-ef.com/uk>

Subject to technical changes and errors. - Generated on 27/11/2024