

139-2052+139-1861

**we-ef**

**FLC260 LED TUNABLE WHITE**



**Description**

Tunable White.

IP66. Class I. IK07. Marine-grade, die-cast aluminum alloy. 5CE superior corrosion protection including PCS hardware. Silicone CCG® Controlled Compression Gasket. Safety glass lens. One cable gland, second gland for through wiring on request. CAD-optimized optics for superior illumination and glare control. Integral driver, thermally separated. OLC® One LED Concept. Factory-installed LED circuit board. Tunable White technology. DMX interface.

Specify product with 7 Digit product code - Finish Color. Accessories, such as mounting, optical, and electrical, must be specified separately.

Example: XXX-XXXX-9004 (Black)  
+ XXX-XXXX (Accessory 1)

|                           |                                |
|---------------------------|--------------------------------|
| Weight                    | 40.79 lb                       |
| Light distribution        | linear spread, narrow beam [N] |
| Light source              | LED-36/132W - 2200-6000 K      |
| CRI                       | 80                             |
| Power supply              | electronic gear                |
| LEDs                      | 36                             |
| Rated input power         | 152 W                          |
| <b>Nominal Lumen (lm)</b> |                                |
| LED Lumen                 | 420                            |
| Total Lumen               | 15120                          |
| Tj                        | 85                             |
| <b>Rated lumens (lm)</b>  |                                |
| LED Lumen                 | 319.6                          |
| Total Lumen               | 11507.2                        |
| Ta                        | 25                             |

**WE-EF LIGHTING USA, LLC**

410-D Keystone Drive, 15086 Warrendale, PA 15086 - Phone: +1 724 742 0030  
customersupport.usa@we-ef.com - <https://we-ef.com/us>  
Subject to technical changes and errors. - Generated on 11/23/2024

**FLC260 LED TUNABLE WHITE**

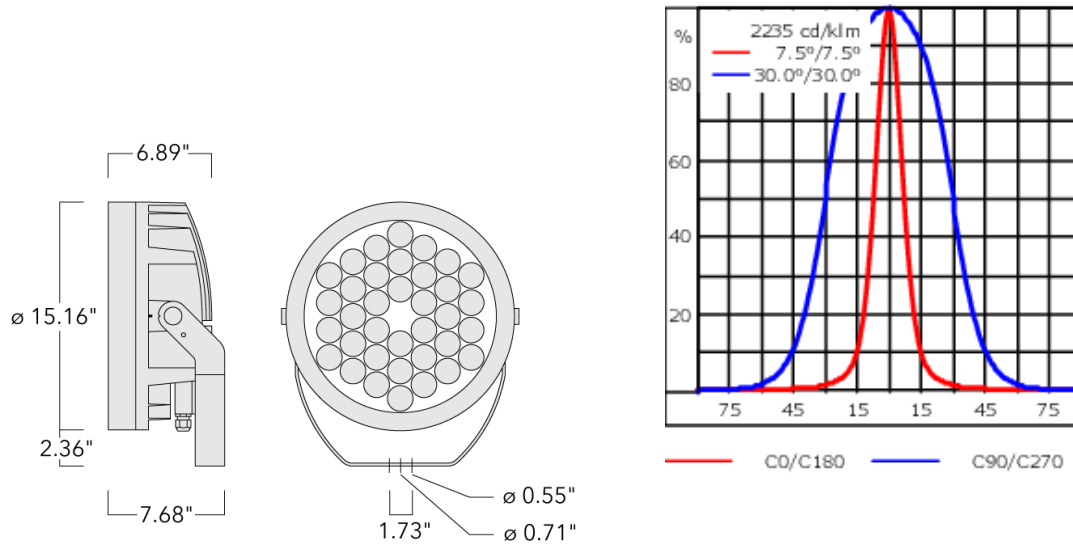

**Specifications**

**Material description**

|                      |   |
|----------------------|---|
| Body                 | Marine-grade, die-cast aluminium alloy  |
| Lens                 | Safety glass lens   |
| Colors               | <div style="display: flex; flex-direction: column; gap: 5px;"> <div><span style="display: inline-block; width: 15px; height: 15px; background-color: black; margin-right: 5px;"></span> RAL9004 Black</div> <div><span style="display: inline-block; width: 15px; height: 15px; background-color: grey; margin-right: 5px;"></span> RAL9007 Grey Metallic</div> <div><span style="display: inline-block; width: 15px; height: 15px; background-color: white; margin-right: 5px;"></span> RAL9016 White</div> <div><span style="display: inline-block; width: 15px; height: 15px; background-color: darkgrey; margin-right: 5px;"></span> RAL8019 Dark Bronze</div> </div> |
| Gasket               | Silicone CCG® Controlled Compression Gasket   |
| Fasteners            | PCS Polymer Coated Stainless Steel Hardware   |
| Ingress protection   | IP66  |
| Impact resistance    | IK07  |
| Corrosion resistance | 5CE   |
| Windage              | 1.5   |

**WE-EF LIGHTING USA, LLC**

410-D Keystone Drive, 15086 Warrendale, PA 15086 - Phone: +1 724 742 0030

customersupport.usa@we-ef.com - <https://we-ef.com/us>

Subject to technical changes and errors. - Generated on 11/23/2024

**139-2052+139-1861**

**we-ef**

**FLC260 LED TUNABLE WHITE**

**Electrical description**

---

|                  |   |
|------------------|---|
| Power supply     | Integral [ECG] electronic driver 120V-277V. DMX enabled driver. |
| Driver / Ballast | 120-277V DMX  |
| Power factor     | >0.9  |
| Surge protection | Integral 10kV Surge Protector                                   |

---

**Additional information**

---

|          |  |
|----------|--|
| Lifetime | Ta=25°/40° L90B10 > 90000h                                 |
| Listings | ETL, UL-1598, CSA-C22.2#250.0. Suitable for Wet Locations. |

---

**WE-EF LIGHTING USA, LLC**

410-D Keystone Drive, 15086 Warrendale, PA 15086 - Phone: +1 724 742 0030  
customersupport.usa@we-ef.com - <https://we-ef.com/us>  
Subject to technical changes and errors. - Generated on 11/23/2024

139-2052+139-1861

**we-ef**

FLC260 LED TUNABLE WHITE

## Optical Accessories

### Wallwash lens

---

| Description      | Part ID  | C1    |
|------------------|----------|-------|
| IO-20-FLC260-LED | 139-1860 | 13.07 |

---

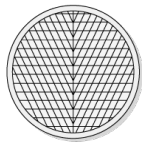

C1

---

#### WE-EF LIGHTING USA, LLC

410-D Keystone Drive, 15086 Warrendale, PA 15086 - Phone: +1 724 742 0030  
customersupport.usa@we-ef.com - <https://we-ef.com/us>

Subject to technical changes and errors. - Generated on 11/23/2024

**FLC260 LED TUNABLE WHITE**

**Linear spread lens**

---

| Description       | Part ID  | C1    |
|-------------------|----------|-------|
| IO-180-FLC260-LED | 139-1861 | 13.07 |

---



---

**Snoot**

---

| Description      | Part ID  | A    | C1    |
|------------------|----------|------|-------|
| ET-FLC260-CC-LED | 139-6976 | 8.74 | 15.47 |
| ET-FLC260-LED    | 139-1865 | 8.74 | 15.47 |

---

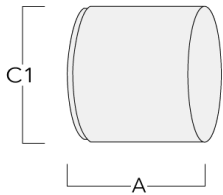

---

**WE-EF LIGHTING USA, LLC**

410-D Keystone Drive, 15086 Warrendale, PA 15086 - Phone: +1 724 742 0030  
customersupport.usa@we-ef.com - <https://we-ef.com/us>  
Subject to technical changes and errors. - Generated on 11/23/2024

**FLC260 LED TUNABLE WHITE**

**Glare shield**

---

| Description      | Part ID  | A    | C1    |
|------------------|----------|------|-------|
| ES-FLC260-CC-LED | 139-6972 | 8.74 | 15.47 |

---

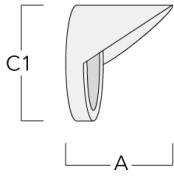

---

|               |          |      |       |
|---------------|----------|------|-------|
| ES-FLC260-LED | 139-1864 | 8.74 | 15.47 |
|---------------|----------|------|-------|

---

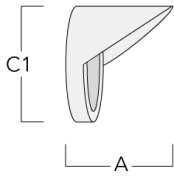

**WE-EF LIGHTING USA, LLC**

410-D Keystone Drive, 15086 Warrendale, PA 15086 - Phone: +1 724 742 0030  
customersupport.usa@we-ef.com - <https://we-ef.com/us>  
Subject to technical changes and errors. - Generated on 11/23/2024

**FLC260 LED TUNABLE WHITE**

**Mounting Accessories**

**Pole clamp TS**

---

| Description                                 | Part ID  | D1       | Weight (lb) | D       |
|---|----------|----------|-------------|---------|
| TS1-2/M16 Pole clamp, single (Ø 4.5"-5.25") | 147-0544 | 4.5-5.25 | 1.70        | 114-133 |

---

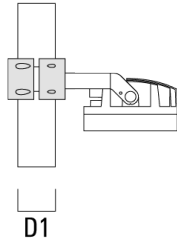
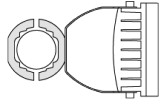

---

|  |          |           |          |       |
|--|----------|-----------|----------|-------|
| TS2-2/M16 Pole clamp, double (Ø 3"-3.5") | 147-0545 | 3.0"-3.5" | 3.09 lbs | 76-89 |
|--|----------|-----------|----------|-------|

---

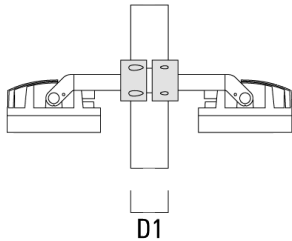
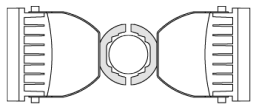

**WE-EF LIGHTING USA, LLC**

410-D Keystone Drive, 15086 Warrendale, PA 15086 - Phone: +1 724 742 0030  
customersupport.usa@we-ef.com - <https://we-ef.com/us>  
Subject to technical changes and errors. - Generated on 11/23/2024

**FLC260 LED TUNABLE WHITE**

**Pole top caps KF**

---

| Description                      | Part ID  | D1   | D × L1   | Weight (lb) | D        |
|----------------------------------|----------|------|----------|-------------|----------|
| KF16-60/M16 Spigot Cap (Ø 2.36") | 310-9120 | 2.36 | 2.36 x 4 | 4.4 lbs     | 60 x 100 |

---

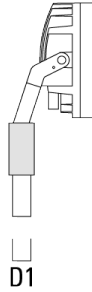

---

|                                |          |   |       |          |          |
|--------------------------------|----------|---|-------|----------|----------|
| KF1-76/M16 Spigot Cap (Ø 3.0") | 310-9121 | 3 | 3 x 4 | 1.10 lbs | 76 x 100 |
|--------------------------------|----------|---|-------|----------|----------|

---

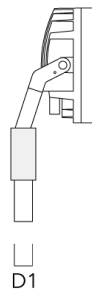

**WE-EF LIGHTING USA, LLC**

410-D Keystone Drive, 15086 Warrendale, PA 15086 - Phone: +1 724 742 0030  
customersupport.usa@we-ef.com - <https://we-ef.com/us>

Subject to technical changes and errors. - Generated on 11/23/2024



**FLC260 LED TUNABLE WHITE**

---

| Description                     | Part ID  | D1   | D × L1  | Weight (lb) | D  |
|---------------------------------|----------|------|---------|-------------|----|
| KF16-89/M16 Spigot Cap (Ø 3.5") | 300-0734 | 3.50 | 3.5 x 3 | 1.10 lbs    | 89 |

---

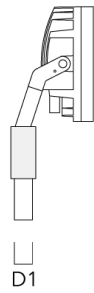

---

|                                   |          |      |          |         |     |
|-----------------------------------|----------|------|----------|---------|-----|
| KF16-108/M16 Spigot Cap (Ø 4.25") | 300-0735 | 4.25 | 4.25 x 3 | 4.4 lbs | 108 |
|-----------------------------------|----------|------|----------|---------|-----|

---

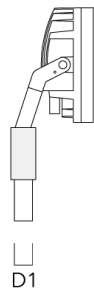

**WE-EF LIGHTING USA, LLC**

410-D Keystone Drive, 15086 Warrendale, PA 15086 - Phone: +1 724 742 0030  
customersupport.usa@we-ef.com - <https://we-ef.com/us>

Subject to technical changes and errors. - Generated on 11/23/2024

**FLC260 LED TUNABLE WHITE**

**Short post EM**

| Description | Part ID  | D1   | D2    | H1 | M1    | Weight (lb) |
|-------------|----------|------|-------|----|-------|-------------|
| EM1-M16 AL  | 270-0001 | 6.3" | 5.12" | 8" | 0.35" | 4.85 lbs    |

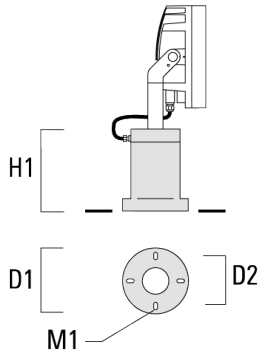

**Surface Mount Canopy SMC**

| Description | Part ID  | D1    | D2   | Weight (lb) |
|-------------|----------|-------|------|-------------|
| SMC-200     | 147-6915 | 10.83 | 9.25 | 15.4 lbs    |

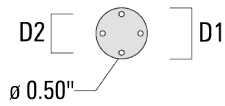

**WE-EF LIGHTING USA, LLC**

410-D Keystone Drive, 15086 Warrendale, PA 15086 - Phone: +1 724 742 0030

customersupport.usa@we-ef.com - <https://we-ef.com/us>

Subject to technical changes and errors. - Generated on 11/23/2024

**FLC260 LED TUNABLE WHITE**

**Junction box**

| Description                            | Part ID  | Additional information   | A    | B    | C1   | Weight (lb) |
|--|----------|--|------|------|------|-------------|
| Junction box JB20 - Cable side entries | 310-9013 | Junction boxes are made from marine-grade, die-cast aluminium alloy. IK10. IP66. For side entries and suitable to be used with cable glands. | 7.09 | 5.63 | 2.01 | 2.25        |

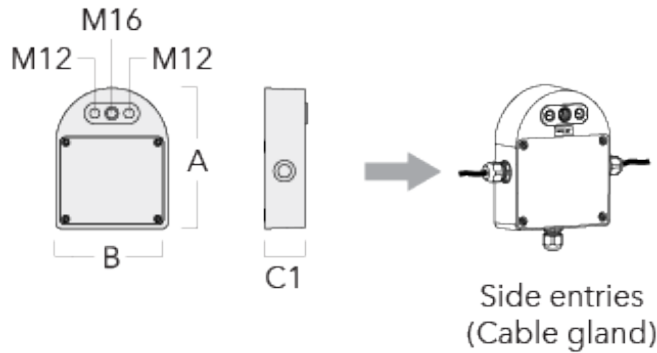

|  |          |  |      |      |      |      |
|--|----------|--|------|------|------|------|
| Junction box JB20 - Conduit side entries | 310-9014 | Junction boxes are made from marine-grade, die-cast aluminium alloy. IK10. IP66. For side entries and suitable to be used with conduits. | 7.09 | 5.63 | 2.01 | 2.25 |
|--|----------|--|------|------|------|------|

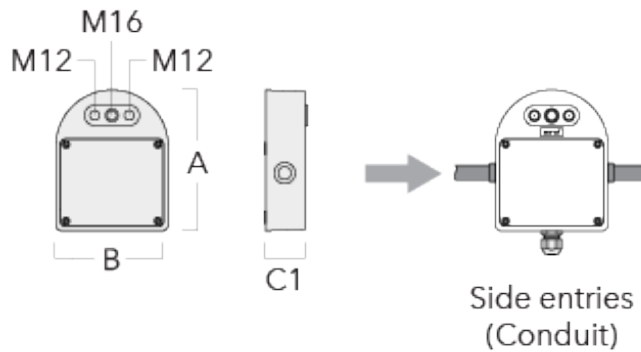

**FLC260 LED TUNABLE WHITE**

**Pole clamp PC**

---

| Description                                 | Part ID  | D1       | Weight (lb) |
|---|----------|----------|-------------|
| PC2 76-89/60 Pole clamp, double (Ø 3"-3.5") | 139-2703 | 3.0-3.50 | 2.20        |

---

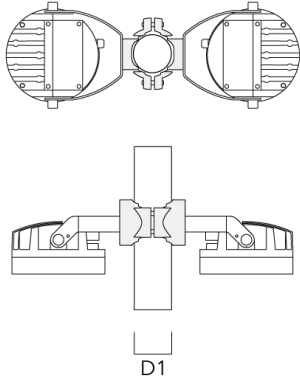

---

|   |          |          |      |
|---|----------|----------|------|
| PC1 76-89/60 Pole clamp, single (Ø 3"-3.5") | 139-2702 | 3.0-3.50 | 2.20 |
|---|----------|----------|------|

---

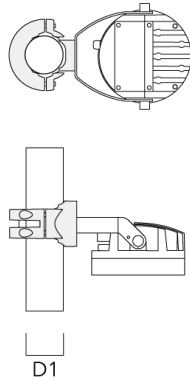

**WE-EF LIGHTING USA, LLC**

410-D Keystone Drive, 15086 Warrendale, PA 15086 - Phone: +1 724 742 0030  
customersupport.usa@we-ef.com - <https://we-ef.com/us>  
Subject to technical changes and errors. - Generated on 11/23/2024

**FLC260 LED TUNABLE WHITE**

---

| Description                                      | Part ID  | D1       | Weight (lb) |
|--|----------|----------|-------------|
| PC2 102-114/60 Pole clamp, double<br>(Ø 4"-4.5") | 139-2707 | 4.0-4.50 | 2.65        |

---

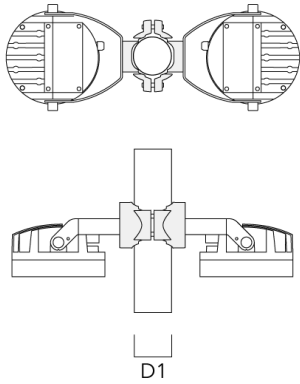

---

|  |          |          |      |
|--|----------|----------|------|
| PC1 102-114/60 Pole clamp, single<br>(Ø 4"-4,5") | 139-2706 | 4.0-4.50 | 2.65 |
|--|----------|----------|------|

---

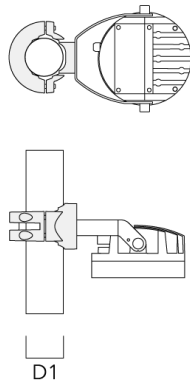

**WE-EF LIGHTING USA, LLC**

410-D Keystone Drive, 15086 Warrendale, PA 15086 - Phone: +1 724 742 0030  
customersupport.usa@we-ef.com - <https://we-ef.com/us>  
Subject to technical changes and errors. - Generated on 11/23/2024

**FLC260 LED TUNABLE WHITE**

---

| Description   | Part ID  | D1       | Weight (lb) |
|---|----------|----------|-------------|
| PC2 114-133/60 Pole clamp, double<br>(Ø 4.5"-5.25") | 139-2709 | 4.5-5.25 | 3.10        |

---

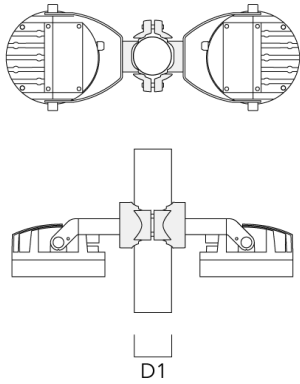

---

|   |          |          |      |
|---|----------|----------|------|
| PC1 114-133/60 Pole clamp, single<br>(Ø 4.5"-5.25") | 139-2708 | 4.5-5.25 | 3.10 |
|---|----------|----------|------|

---

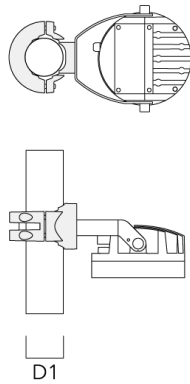

**WE-EF LIGHTING USA, LLC**

410-D Keystone Drive, 15086 Warrendale, PA 15086 - Phone: +1 724 742 0030  
customersupport.usa@we-ef.com - <https://we-ef.com/us>  
Subject to technical changes and errors. - Generated on 11/23/2024

**FLC260 LED TUNABLE WHITE**

---

| Description   | Part ID  | D1        | Weight (lb) |
|---|----------|-----------|-------------|
| PC2 82-109/60 Pole clamp, double<br>(Ø 3.25"-4.25") | 139-2705 | 3.20-4.30 | 2.40        |

---

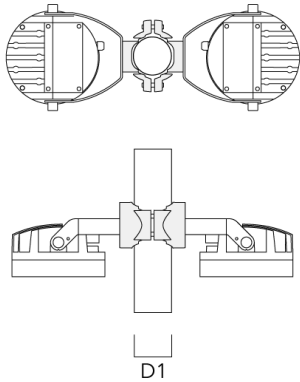

**139-2052+139-1861**

**we-ef**

**FLC260 LED TUNABLE WHITE**

## **Control**

### **DMX Wireless Repeater**

---

| Description           | Part ID  |
|-----------------------|----------|
| DMX Wireless Repeater | 400-0477 |

---



---

#### **WE-EF LIGHTING USA, LLC**

410-D Keystone Drive, 15086 Warrendale, PA 15086 - Phone: +1 724 742 0030  
customersupport.usa@we-ef.com - <https://we-ef.com/us>

Subject to technical changes and errors. - Generated on 11/23/2024



139-2052+139-1861

**we-ef**

**FLC260 LED TUNABLE WHITE**

### DMX Wireless Transceiver

---

| Description              | Part ID  |
|--------------------------|----------|
| DMX Wireless Transceiver | 400-0476 |

---



---

### DMX Booster Box

---

| Description     | Part ID  |
|-----------------|----------|
| DMX Booster Box | 400-0474 |

---



---

#### WE-EF LIGHTING USA, LLC

410-D Keystone Drive, 15086 Warrendale, PA 15086 - Phone: +1 724 742 0030  
customersupport.usa@we-ef.com - <https://we-ef.com/us>  
Subject to technical changes and errors. - Generated on 11/23/2024

**FLC260 LED TUNABLE WHITE**

**DMX Combination Cable**

---

| Description           | Part ID  |
|-----------------------|----------|
| DMX Combination Cable | 400-0480 |

---



---

**DMX Controller**

---

| Description    | Part ID  | Additional information  |
|----------------|----------|---|
| DMX Controller | 400-0469 | IP20. DIN Rail system. Is designed for either live or stand-alone control. It features one DMX universe, a USBconnection, 128k flash memory for storing stand-alone programs. |

---

**WE-EF LIGHTING USA, LLC**

410-D Keystone Drive, 15086 Warrendale, PA 15086 - Phone: +1 724 742 0030  
customersupport.usa@we-ef.com - <https://we-ef.com/us>  
Subject to technical changes and errors. - Generated on 11/23/2024

**FLC260 LED TUNABLE WHITE**

**DMX Controller (smart)**

---

| Description            | Part ID  | Additional information  |
|------------------------|----------|---|
| DMX Controller (smart) | 400-0470 | IP20. The Touch Panel is an intuitive and easy-to-use keypad or one DMX universe. It can store up to 36 scenes; alternatively, via .... |

---



---

**DMX Controller (smart) - RDM ready**

---

| Description                        | Part ID  |
|------------------------------------|----------|
| DMX Controller (smart) - RDM ready | 400-0472 |

---

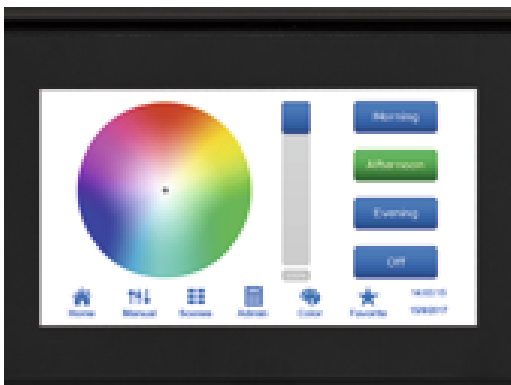

---

**WE-EF LIGHTING USA, LLC**

410-D Keystone Drive, 15086 Warrendale, PA 15086 - Phone: +1 724 742 0030  
customersupport.usa@we-ef.com - <https://we-ef.com/us>  
Subject to technical changes and errors. - Generated on 11/23/2024

**FLC260 LED TUNABLE WHITE**

**DMX Controller - RDM ready**

| Description                | Part ID  |
|----------------------------|----------|
| DMX Controller - RDM ready | 400-0471 |



**DMX Plug and Socket**

| Description         | Part ID  |
|---------------------|----------|
| DMX Plug and Socket | 400-0479 |

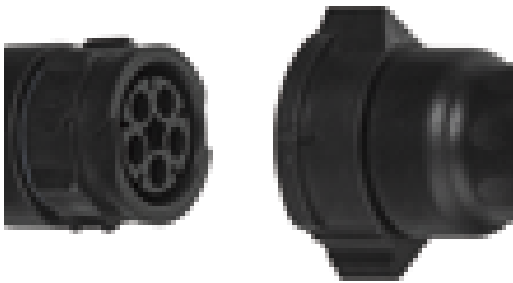

**WE-EF LIGHTING USA, LLC**

410-D Keystone Drive, 15086 Warrendale, PA 15086 - Phone: +1 724 742 0030

customersupport.usa@we-ef.com - <https://we-ef.com/us>

Subject to technical changes and errors. - Generated on 11/23/2024

**FLC260 LED TUNABLE WHITE**

**DMX Splitter**

---

| Description  | Part ID  |
|--------------|----------|
| DMX Splitter | 400-0473 |

---



---

**DMX Termination Plug**

---

| Description          | Part ID  |
|----------------------|----------|
| DMX Termination Plug | 400-0475 |

---



---

**WE-EF LIGHTING USA, LLC**

410-D Keystone Drive, 15086 Warrendale, PA 15086 - Phone: +1 724 742 0030  
customersupport.usa@we-ef.com - <https://we-ef.com/us>  
Subject to technical changes and errors. - Generated on 11/23/2024

**139-2052+139-1861**

**we-ef**

**FLC260 LED TUNABLE WHITE**

**DMX Wireless Antenna**

---

| Description  | Part ID  |
|--------------|----------|
| DMX Wireless | 430-0018 |

---

**WE-EF LIGHTING USA, LLC**

410-D Keystone Drive, 15086 Warrendale, PA 15086 - Phone: +1 724 742 0030  
customersupport.usa@we-ef.com - <https://we-ef.com/us>

Subject to technical changes and errors. - Generated on 11/23/2024