



### Beschreibung

Tunable White. IP66, SKI. SKII auf Anfrage. IK07. Korrosionsbeständiger Aluminiumguss. PCS beschichtete Edelstahlschrauben. 5CE Korrosionsschutz. CCG\_R\_ Silikonichtung. Sicherheitsglas. Eine Kabelverschraubung, eine zweite Kabelverschraubung zur Durchverdrahtung auf Anfrage. Eingebaute elektronische Betriebsgeräte, thermisch getrennt. CAD-optimierte OLC\_R\_ One LED Concept Technik zur Lichtlenkung und Entblendung. Eingebaute LED Platine mit Tunable White Technologie. DALI Schnittstelle.

Gewicht	18.50 kg
Lichtverteilung	bandförmig engstrahlend [E]
Lichtquelle	LED-36/132W - 2200-6000 K
CRI	80
Netz	EVG
LEDs	36
Bemessungsleistung	152 W

### Nominal Lichtstrom (lm)

LED Lumen	420
Total Lumen	15120
Tj	85

### Bemessungslichtstrom (lm)

LED Lumen	319.6
Total Lumen	11507.2
Ta	25

## FLC260-TW LED

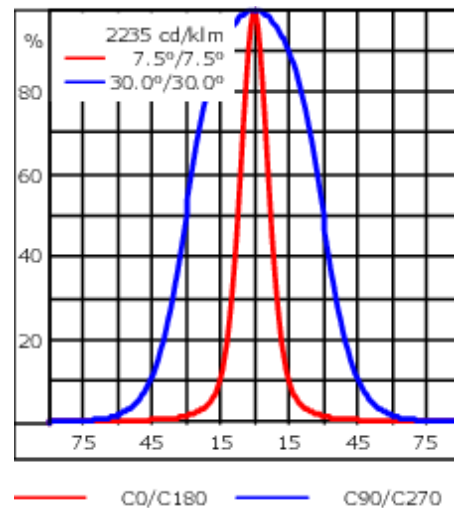
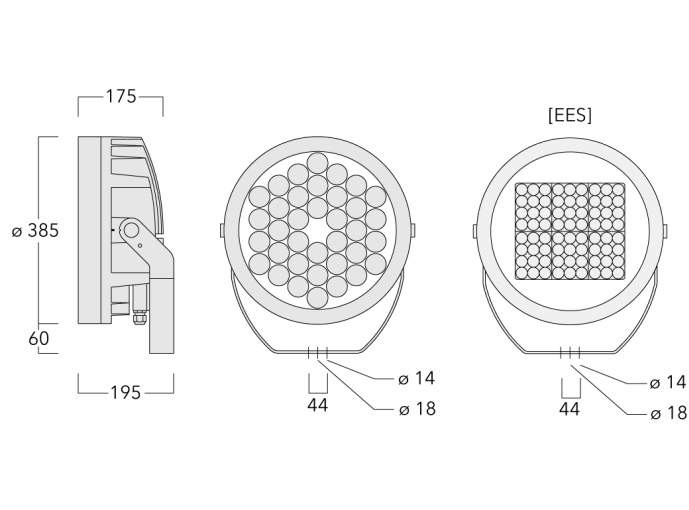

## Spezifikationen

### Materialbeschreibung

Gehäuse	Korrosionsbeständiges Aluminium
Abdeckung	Sicherheitsglasscheibe
Farben	<div style="display: flex; align-items: center;"> <div style="width: 20px; height: 10px; background-color: black; margin-right: 5px;"></div> <span>RAL9004 Signalschwarz</span> </div> <div style="display: flex; align-items: center; margin-top: 5px;"> <div style="width: 20px; height: 10px; background-color: gray; margin-right: 5px;"></div> <span>RAL9007 Graualuminium</span> </div> <div style="display: flex; align-items: center; margin-top: 5px;"> <div style="width: 20px; height: 10px; background-color: darkgray; margin-right: 5px;"></div> <span>RAL7016 Anthrazitgrau</span> </div> <div style="display: flex; align-items: center; margin-top: 5px;"> <div style="width: 20px; height: 10px; background-color: lightgray; margin-right: 5px;"></div> <span>RAL9016 Verkehrsweiß</span> </div>
Dichtung	CCG® Silikondichtung
Schrauben	PCS beschichtete Edelstahlschrauben
Schutzart	IP66
Schlagfestigkeit	IK07
Korrosionsbeständigkeit	5CE
Windangriffsfläche	0.116 m <sup>2</sup>

### Elektrische Beschreibung

Netzgerät / Vorschaltgerät	DALI
-------------------------------	------

### Weitere Informationen

Lebensdauer	Ta=25° L90B10 > 90000h
Energieeffizienzklasse	E (Lichtquelle)

#### WE-EF Switzerland AG

Himmelrichstrasse 6, 6003 Luzern - Tel: +41 41 210 49 95  
 info.switzerland@we-ef.com - [https://we-ef.com/ch\\_de](https://we-ef.com/ch_de)  
 Technische Änderungen und Irrtümer vorbehalten. - Erstellt am 23.11.2024

139-2052+139-1861

FLC260-TW LED

**we-ef**

## Optisches Zubehör

### Streulinse bandförmig

---

Beschreibung	Artikelnummer	C1
IO-180-FLC260-LED	139-1861	332

---

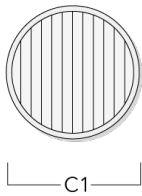

---

### Abblendtubus

---

Beschreibung	Artikelnummer	A	C1
ET-FLC260-LED	139-1865	222	393

---



---

#### WE-EF Switzerland AG

Himmelrichstrasse 6, 6003 Luzern - Tel: +41 41 210 49 95

info.switzerland@we-ef.com - [https://we-ef.com/ch\\_de](https://we-ef.com/ch_de)

Technische Änderungen und Irrtümer vorbehalten. - Erstellt am 23.11.2024

**FLC260-TW LED**

**Seitenblende**

---

Beschreibung	Artikelnummer	A	C1
ES-FLC260-LED	139-1864	222	393

---

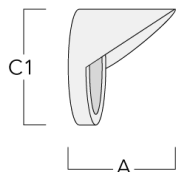

## Montagezubehör

## Mastschelle TS

Beschreibung	Artikelnummer	D1	Gewicht (kg)	D
TS1-2/M12 Mastschelle, einfach (Ø 114-133)	147-0544	114-133	1.70	114-133

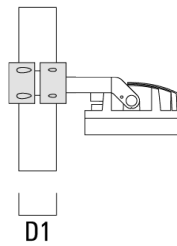
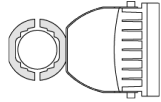

TS2-2/M12 Mastschelle, zweifach (Ø 76-89)	147-0545	76-89	1.40	76-89
---	----------	-------	------	-------

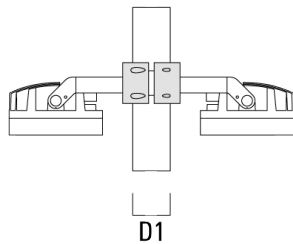
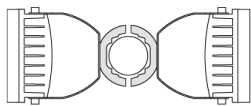

## FLC260-TW LED

## Mastaufsatztraverse TA

Beschreibung	Artikelnummer	C1	D x L1	Gewicht (kg)	D x S
TA1 Mastaufsatztraverse, einfach* (Ø 76 x 200)	147-0023	130	76 x 200	1.90	76 x 200

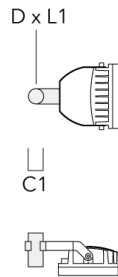

## Mastschelle PC

Beschreibung	Artikelnummer	D1	Gewicht (kg)
PC2 76-89/60 Mastschelle, zweifach (Ø 76-89)	139-2703	76-89	1.00

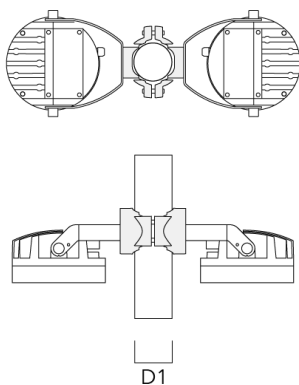

## WE-EF Switzerland AG

Himmelrichstrasse 6, 6003 Luzern - Tel: +41 41 210 49 95  
 info.switzerland@we-ef.com - [https://we-ef.com/ch\\_de](https://we-ef.com/ch_de)  
 Technische Änderungen und Irrtümer vorbehalten. - Erstellt am 23.11.2024

**FLC260-TW LED**

Beschreibung	Artikelnummer	D1	Gewicht (kg)
PC1 76-89/60 Mastschelle, einfach (Ø 76-89)	139-2702	76-89	1.00

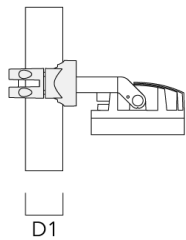
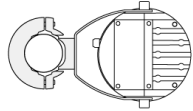

PC2 102-114/60 Mastschelle, zweifach (Ø 102-114)	139-2707	102-114	1.20
--	----------	---------	------

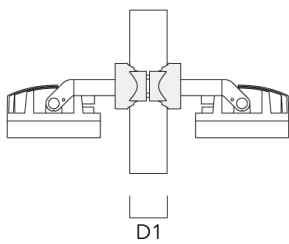
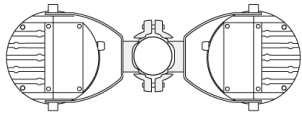

## FLC260-TW LED

Beschreibung	Artikelnummer	D1	Gewicht (kg)
PC1 102-114/60 Mastschelle, einfach (Ø 102-114)	139-2706	102-114	1.20

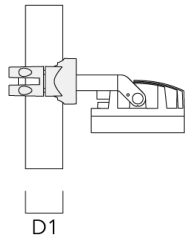
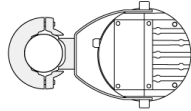

PC2 114-133/60 Mastschelle, zweifach (Ø 114-133)	139-2709	114-133	1.40
---	----------	---------	------

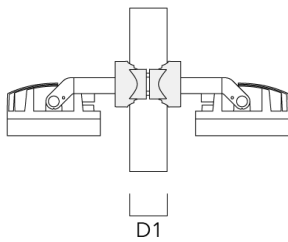
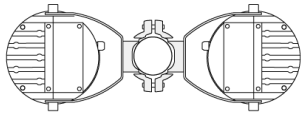



## FLC260-TW LED

---

Beschreibung	Artikelnummer	D1	Gewicht (kg)
PC1 114-133/60 Mastschelle, einfach (Ø 114-133)	139-2708	114-133	1.40

---

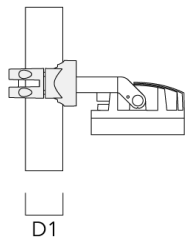
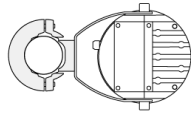

---

PC2 82-109/60 Mastschelle, zweifach (Ø 82-109)	139-2705	82-109	1.10
---	----------	--------	------

---

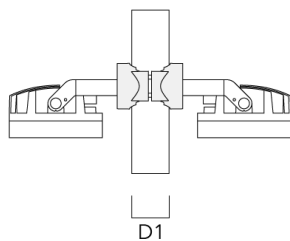
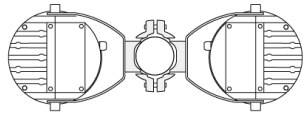

## Steuerung

### DMX Wireless Repeater

---

Beschreibung	Artikelnummer
DMX Wireless Repeater	400-0477

---



---

### DMX Wireless Transceiver

---

Beschreibung	Artikelnummer
DMX Wireless Transceiver	400-0476

---

