

139-2051+139-1860

we-ef

FLC260 LED TUNABLE WHITE



Description

Tunable White.

IP66. Class I. IK07. Marine-grade, die-cast aluminum alloy. 5CE superior corrosion protection including PCS hardware. Silicone CCG® Controlled Compression Gasket. Safety glass lens. One cable gland, second gland for through wiring on request. CAD-optimized optics for superior illumination and glare control. Integral driver, thermally separated. OLC® One LED Concept. Factory-installed LED circuit board. Tunable White technology. DMX interface.

Specify product with 7 Digit product code - Finish Color. Accessories, such as mounting, optical, and electrical, must be specified separately.

Example: XXX-XXXX-9004 (Black)
+ XXX-XXXX (Accessory 1)

Weight	40.79 lb
Light distribution	wallwash
Light source	LED-36/132W - 2200-6000 K
CRI	80
Power supply	electronic gear
LEDs	36
Rated input power	152 W

Nominal Lumen (lm)

LED Lumen	420
Total Lumen	15120
Tj	85

Rated lumens (lm)

LED Lumen	278.6
Total Lumen	10029.3
Ta	25

WE-EF LIGHTING USA, LLC

410-D Keystone Drive, 15086 Warrendale, PA 15086 - Phone: +1 724 742 0030
customersupport.usa@we-ef.com - <https://we-ef.com/us>
Subject to technical changes and errors. - Generated on 11/23/2024

FLC260 LED TUNABLE WHITE

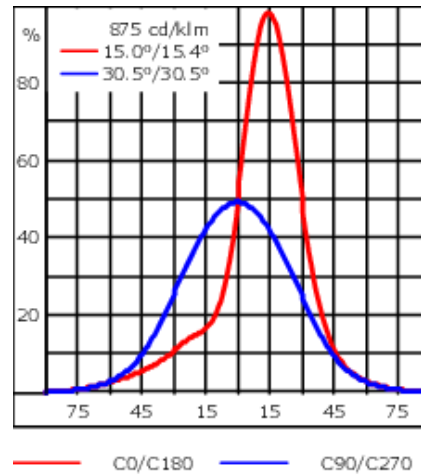
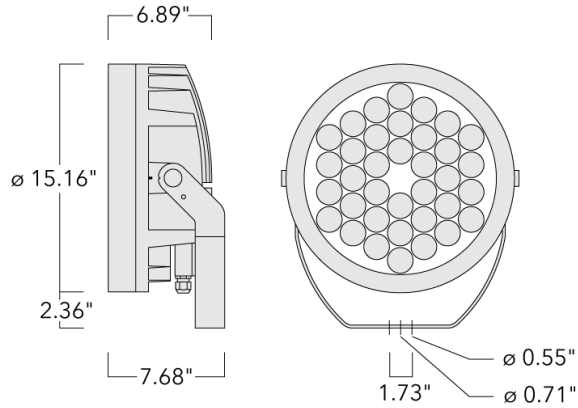

Specifications

Material description

Body	Marine-grade, die-cast aluminium alloy
Lens	Safety glass lens
Colors	<ul style="list-style-type: none"> RAL9004 Black RAL9007 Grey Metallic RAL9016 White RAL8019 Dark Bronze
Gasket	Silicone CCG® Controlled Compression Gasket
Fasteners	PCS Polymer Coated Stainless Steel Hardware
Ingress protection	IP66
Impact resistance	IK07
Corrosion resistance	5CE
Windage	1.5

WE-EF LIGHTING USA, LLC

410-D Keystone Drive, 15086 Warrendale, PA 15086 - Phone: +1 724 742 0030

customersupport.usa@we-ef.com - <https://we-ef.com/us>

Subject to technical changes and errors. - Generated on 11/23/2024

139-2051+139-1860

we-ef

FLC260 LED TUNABLE WHITE

Electrical description

Power supply	Integral [ECG] electronic driver 120V-277V. DMX enabled driver.
Driver / Ballast	120-277V DMX
Power factor	>0.9
Surge protection	Integral 10kV Surge Protector

Additional information

Lifetime	Ta=25°/40° L90B10 > 90000h
Listings	ETL, UL-1598, CSA-C22.2#250.0. Suitable for Wet Locations.

WE-EF LIGHTING USA, LLC

410-D Keystone Drive, 15086 Warrendale, PA 15086 - Phone: +1 724 742 0030
customersupport.usa@we-ef.com - <https://we-ef.com/us>
Subject to technical changes and errors. - Generated on 11/23/2024

139-2051+139-1860

we-ef

FLC260 LED TUNABLE WHITE

Optical Accessories

Wallwash lens

Description	Part ID	C1
IO-20-FLC260-LED	139-1860	13.07

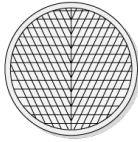

C1

WE-EF LIGHTING USA, LLC

410-D Keystone Drive, 15086 Warrendale, PA 15086 - Phone: +1 724 742 0030
customersupport.usa@we-ef.com - <https://we-ef.com/us>

Subject to technical changes and errors. - Generated on 11/23/2024

FLC260 LED TUNABLE WHITE

Linear spread lens

Description	Part ID	C1
IO-180-FLC260-LED	139-1861	13.07



Snoot

Description	Part ID	A	C1
ET-FLC260-CC-LED	139-6976	8.74	15.47
ET-FLC260-LED	139-1865	8.74	15.47

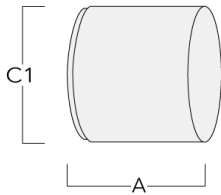

WE-EF LIGHTING USA, LLC

410-D Keystone Drive, 15086 Warrendale, PA 15086 - Phone: +1 724 742 0030
customersupport.usa@we-ef.com - <https://we-ef.com/us>
Subject to technical changes and errors. - Generated on 11/23/2024

FLC260 LED TUNABLE WHITE

Glare shield

Description	Part ID	A	C1
ES-FLC260-CC-LED	139-6972	8.74	15.47

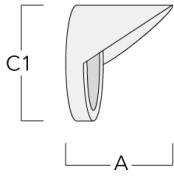

ES-FLC260-LED	139-1864	8.74	15.47
---------------	----------	------	-------

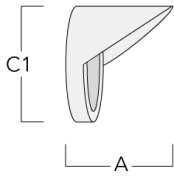

FLC260 LED TUNABLE WHITE

Mounting Accessories

Pole clamp TS

Description	Part ID	D1	Weight (lb)	D
TS1-2/M16 Pole clamp, single (Ø 4.5"-5.25")	147-0544	4.5-5.25	1.70	114-133

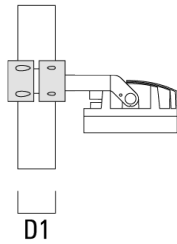
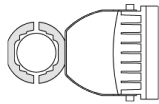

TS2-2/M16 Pole clamp, double (Ø 3"-3.5")	147-0545	3.0"-3.5"	3.09 lbs	76-89
--	----------	-----------	----------	-------

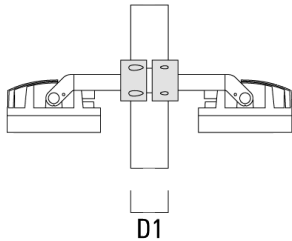
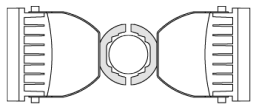

WE-EF LIGHTING USA, LLC

410-D Keystone Drive, 15086 Warrendale, PA 15086 - Phone: +1 724 742 0030

customersupport.usa@we-ef.com - <https://we-ef.com/us>

Subject to technical changes and errors. - Generated on 11/23/2024

FLC260 LED TUNABLE WHITE

Pole top caps KF

Description	Part ID	D1	D × L1	Weight (lb)	D
KF16-60/M16 Spigot Cap (Ø 2.36")	310-9120	2.36	2.36 x 4	4.4 lbs	60 x 100

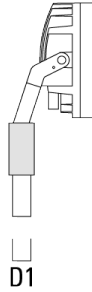

KF1-76/M16 Spigot Cap (Ø 3.0")	310-9121	3	3 x 4	1.10 lbs	76 x 100
--------------------------------	----------	---	-------	----------	----------

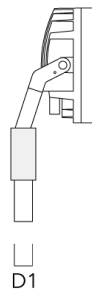

WE-EF LIGHTING USA, LLC

410-D Keystone Drive, 15086 Warrendale, PA 15086 - Phone: +1 724 742 0030
customersupport.usa@we-ef.com - <https://we-ef.com/us>

Subject to technical changes and errors. - Generated on 11/23/2024

FLC260 LED TUNABLE WHITE

Description	Part ID	D1	D × L1	Weight (lb)	D
KF16-89/M16 Spigot Cap (Ø 3.5")	300-0734	3.50	3.5 x 3	1.10 lbs	89

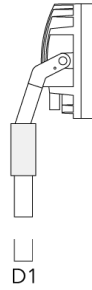

KF16-108/M16 Spigot Cap (Ø 4.25")	300-0735	4.25	4.25 x 3	4.4 lbs	108
-----------------------------------	----------	------	----------	---------	-----

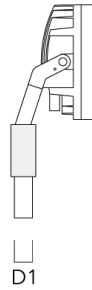

WE-EF LIGHTING USA, LLC

410-D Keystone Drive, 15086 Warrendale, PA 15086 - Phone: +1 724 742 0030
customersupport.usa@we-ef.com - <https://we-ef.com/us>
Subject to technical changes and errors. - Generated on 11/23/2024

FLC260 LED TUNABLE WHITE

Short post EM

Description	Part ID	D1	D2	H1	M1	Weight (lb)
EM1-M16 AL	270-0001	6.3"	5.12"	8"	0.35"	4.85 lbs

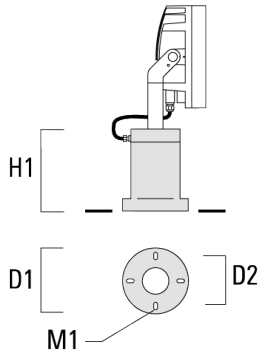

Surface Mount Canopy SMC

Description	Part ID	D1	D2	Weight (lb)
SMC-200	147-6915	10.83	9.25	15.4 lbs

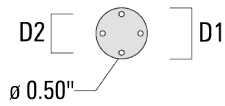

WE-EF LIGHTING USA, LLC

410-D Keystone Drive, 15086 Warrendale, PA 15086 - Phone: +1 724 742 0030
 customersupport.usa@we-ef.com - <https://we-ef.com/us>
 Subject to technical changes and errors. - Generated on 11/23/2024

FLC260 LED TUNABLE WHITE

Junction box

Description	Part ID	Additional information	A	B	C1	Weight (lb)
Junction box JB20 - Cable side entries	310-9013	Junction boxes are made from marine-grade, die-cast aluminium alloy. IK10. IP66. For side entries and suitable to be used with cable glands.	7.09	5.63	2.01	2.25

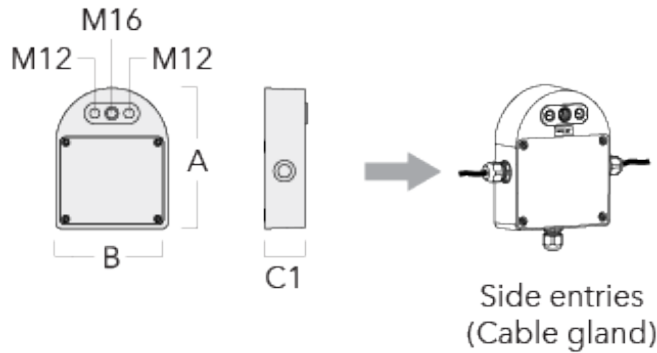

Junction box JB20 - Conduit side entries	310-9014	Junction boxes are made from marine-grade, die-cast aluminium alloy. IK10. IP66. For side entries and suitable to be used with conduits.	7.09	5.63	2.01	2.25
--	----------	--	------	------	------	------

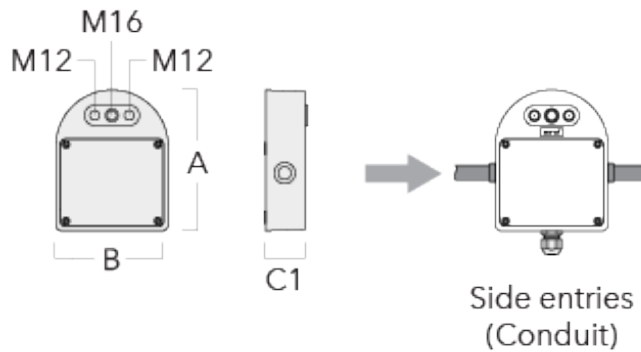

FLC260 LED TUNABLE WHITE

Pole clamp PC

Description	Part ID	D1	Weight (lb)
PC2 76-89/60 Pole clamp, double (Ø 3"-3.5")	139-2703	3.0-3.50	2.20

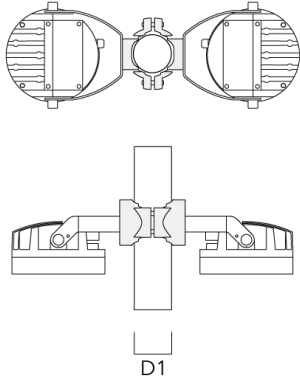

PC1 76-89/60 Pole clamp, single (Ø 3"-3.5")	139-2702	3.0-3.50	2.20
---	----------	----------	------

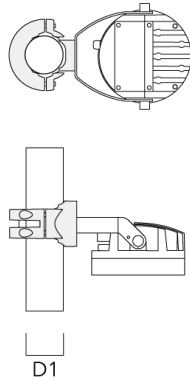

WE-EF LIGHTING USA, LLC

410-D Keystone Drive, 15086 Warrendale, PA 15086 - Phone: +1 724 742 0030
customersupport.usa@we-ef.com - <https://we-ef.com/us>
Subject to technical changes and errors. - Generated on 11/23/2024

FLC260 LED TUNABLE WHITE

Description	Part ID	D1	Weight (lb)
PC2 102-114/60 Pole clamp, double (Ø 4"-4.5")	139-2707	4.0-4.50	2.65

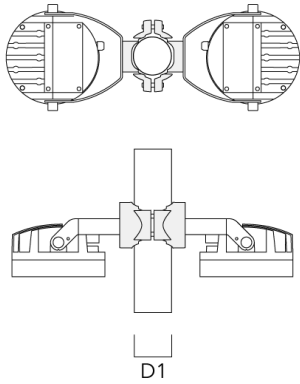

PC1 102-114/60 Pole clamp, single (Ø 4"-4,5")	139-2706	4.0-4.50	2.65
--	----------	----------	------

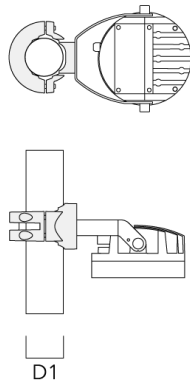

WE-EF LIGHTING USA, LLC

410-D Keystone Drive, 15086 Warrendale, PA 15086 - Phone: +1 724 742 0030
customersupport.usa@we-ef.com - <https://we-ef.com/us>
Subject to technical changes and errors. - Generated on 11/23/2024

FLC260 LED TUNABLE WHITE

Description	Part ID	D1	Weight (lb)
PC2 114-133/60 Pole clamp, double (Ø 4.5"-5.25")	139-2709	4.5-5.25	3.10

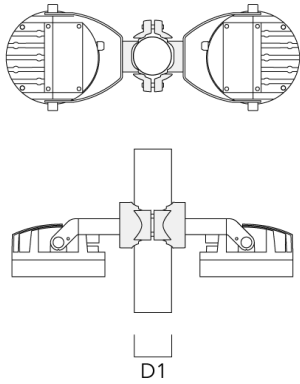

PC1 114-133/60 Pole clamp, single (Ø 4.5"-5.25")	139-2708	4.5-5.25	3.10
---	----------	----------	------

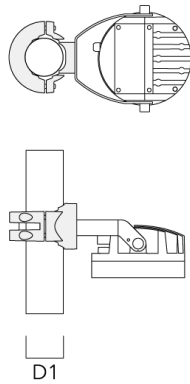

WE-EF LIGHTING USA, LLC

410-D Keystone Drive, 15086 Warrendale, PA 15086 - Phone: +1 724 742 0030
customersupport.usa@we-ef.com - <https://we-ef.com/us>
Subject to technical changes and errors. - Generated on 11/23/2024

FLC260 LED TUNABLE WHITE

Description	Part ID	D1	Weight (lb)
PC2 82-109/60 Pole clamp, double (Ø 3.25"-4.25")	139-2705	3.20-4.30	2.40

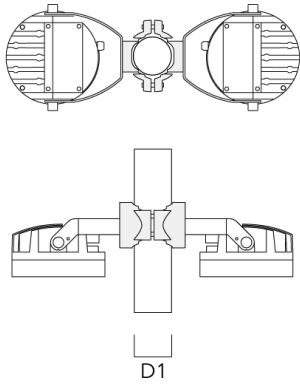

139-2051+139-1860

we-ef

FLC260 LED TUNABLE WHITE

Control

DMX Wireless Repeater

Description	Part ID
DMX Wireless Repeater	400-0477



WE-EF LIGHTING USA, LLC

410-D Keystone Drive, 15086 Warrendale, PA 15086 - Phone: +1 724 742 0030
customersupport.usa@we-ef.com - <https://we-ef.com/us>

Subject to technical changes and errors. - Generated on 11/23/2024

139-2051+139-1860

we-ef

FLC260 LED TUNABLE WHITE

DMX Wireless Transceiver

Description	Part ID
DMX Wireless Transceiver	400-0476



DMX Booster Box

Description	Part ID
DMX Booster Box	400-0474



WE-EF LIGHTING USA, LLC

410-D Keystone Drive, 15086 Warrendale, PA 15086 - Phone: +1 724 742 0030
customersupport.usa@we-ef.com - <https://we-ef.com/us>

Subject to technical changes and errors. - Generated on 11/23/2024

FLC260 LED TUNABLE WHITE

DMX Combination Cable

Description	Part ID
DMX Combination Cable	400-0480



DMX Controller

Description	Part ID	Additional information
DMX Controller	400-0469	IP20. DIN Rail system. Is designed for either live or stand-alone control. It features one DMX universe, a USBconnection, 128k flash memory for storing stand-alone programs.

WE-EF LIGHTING USA, LLC

410-D Keystone Drive, 15086 Warrendale, PA 15086 - Phone: +1 724 742 0030
customersupport.usa@we-ef.com - <https://we-ef.com/us>
Subject to technical changes and errors. - Generated on 11/23/2024

FLC260 LED TUNABLE WHITE

DMX Controller (smart)

Description	Part ID	Additional information
DMX Controller (smart)	400-0470	IP20. The Touch Panel is an intuitive and easy-to-use keypad or one DMX universe. It can store up to 36 scenes; alternatively, via



DMX Controller (smart) - RDM ready

Description	Part ID
DMX Controller (smart) - RDM ready	400-0472

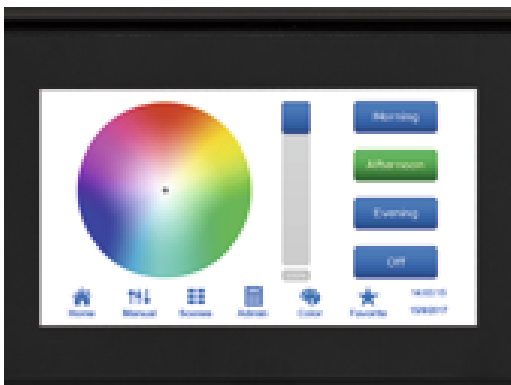

WE-EF LIGHTING USA, LLC

410-D Keystone Drive, 15086 Warrendale, PA 15086 - Phone: +1 724 742 0030
 customersupport.usa@we-ef.com - <https://we-ef.com/us>
 Subject to technical changes and errors. - Generated on 11/23/2024

139-2051+139-1860

we-ef

FLC260 LED TUNABLE WHITE

DMX Controller - RDM ready

Description	Part ID
DMX Controller - RDM ready	400-0471



DMX Plug and Socket

Description	Part ID
DMX Plug and Socket	400-0479

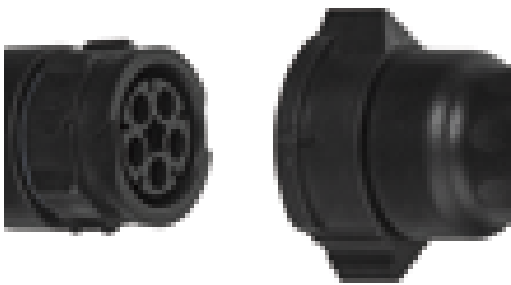

WE-EF LIGHTING USA, LLC

410-D Keystone Drive, 15086 Warrendale, PA 15086 - Phone: +1 724 742 0030

customersupport.usa@we-ef.com - <https://we-ef.com/us>

Subject to technical changes and errors. - Generated on 11/23/2024

FLC260 LED TUNABLE WHITE

DMX Splitter

Description	Part ID
DMX Splitter	400-0473



DMX Termination Plug

Description	Part ID
DMX Termination Plug	400-0475



WE-EF LIGHTING USA, LLC

410-D Keystone Drive, 15086 Warrendale, PA 15086 - Phone: +1 724 742 0030

customersupport.usa@we-ef.com - <https://we-ef.com/us>

Subject to technical changes and errors. - Generated on 11/23/2024

139-2051+139-1860

we-ef

FLC260 LED TUNABLE WHITE

DMX Wireless Antenna

Description	Part ID
DMX Wireless	430-0018

WE-EF LIGHTING USA, LLC

410-D Keystone Drive, 15086 Warrendale, PA 15086 - Phone: +1 724 742 0030
customersupport.usa@we-ef.com - <https://we-ef.com/us>

Subject to technical changes and errors. - Generated on 11/23/2024