



Description

RGBW/RGBA Colour Changer. IP67*, Class I. IK10+. Stainless steel construction including PCS hardware. Silicone rubber gasket. Safety glass lens; max. load 5 tonnes. Luminaire can be driven over at low speed. Factory-sealed termination chamber complete with cable gland and 1.5 m of flexible PVC free cable. Cable gland with spiral cable bending protection. Integral EC electronic converter in thermally separated compartment. 'No tool' removable gear/lens tray. CAD-optimised optics for superior illumination and glare control. OLC® One LED Concept. Factory-installed LED circuit board with WE-EF Colour Boost Technology. DMX interface. Gimbal mounted, 360° rotatable and 30° tiltable.

The optional installation blackout is recommended for mounting. To be ordered separately.

Optional with Anti-Slip ceramic Coating ASC to DIN 51130 (Trip Classification 10) available on request.

The luminaire is not suitable for permanent underwater operation and must be switched off in the event of flooding.

* Additionally tested to IP66, IP67, IP68 0.1 bar 3h, up

Weight	6.20 kg
Light distribution	symmetric, medium beam [M]
Light source	LED-12/19W - RGBW/4K
CRI	20/80
Power supply	EC
LEDs	12
Rated input power	23 W

Nominal Lumen (lm)

LED Lumen	160
Total Lumen	1920
Tj	85

Rated lumens (lm)

LED Lumen	110.6
Total Lumen	1327.4
Ta	25

Fagerhult Lighting Ltd

33-34 Dolben Street, SE1 0UQ London, United Kingdom

<https://we-ef.com/uk>

Subject to technical changes and errors. - Generated on 19/04/2025

185-3390

ETC130-GB-CC LED

we-ef

to 1 m depth according to DIN EN 60598 and IP69K/80°
according to DIN EN 60529.

Fagerhult Lighting Ltd

33-34 Dolben Street, SE1 0UQ London, United Kingdom

<https://we-ef.com/uk>

Subject to technical changes and errors. - Generated on 19/04/2025

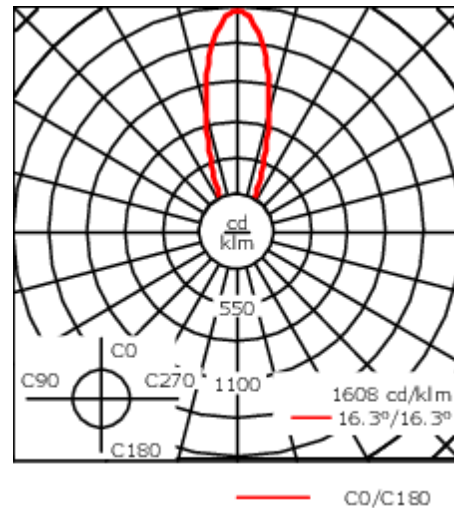
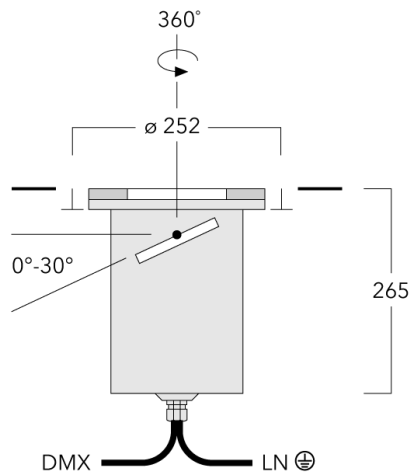

Specifications

Material description

Body	Stainless steel construction
Lens	Safety glass lens; max. load 5 tonnes
Colours	 Stainless Steel
Gasket	Silicone rubber gasket
Fasteners	PCS Polymer Coated Stainless Steel Hardware
Ingress protection	IP67
Impact resistance	IK10+

Electrical description

Power supply	220-240V / 50-60 Hz
Driver / Ballast	Integral EC electronic converter
Power factor	> 0.9
Surge protection	1/2 kV (optional SP10)

Additional information

Lifetime	Ta=25° L90B10 > 90000h
Energieeffizienzklasse	C-D (Light source)

Mounting Accessories

Installation blackout

Description	Part ID	D1	D2	H1	Weight (kg)	D	H
Blockout, Plastic	185-0322	250	270	375	1.50	250/270	375

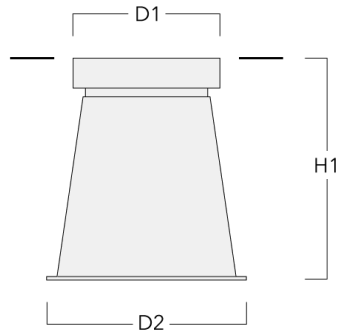

Installation cover

Description	Part ID	C1
Installation cover BE	185-0325	250

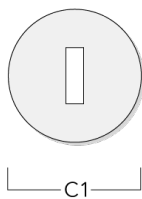

Electrical Accessories

Sealable junction box

Description	Part ID	C1	M1	M2
Sealable junction box SJB130	185-1624	146	Ø 10	Ø 12 - 19

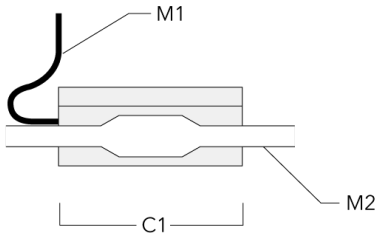

Sealable junction box SJB130 (DMX - in/out)	185-3198	146	Ø 10	Ø 12 - 19
---	----------	-----	------	-----------

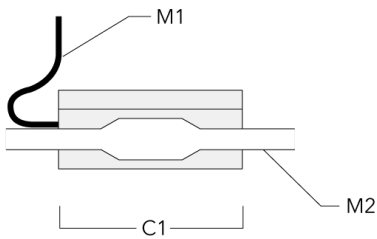

185-3390

ETC130-GB-CC LED

we-ef

Control

DMX Wireless Antenna

Description	Part ID
Antenna RF1.8dB	430-0018

DMX Motion Sensor

Description	Part ID
DMX Motion Sensor	400-0478



DMX Controller

Description	Part ID	Additional information
DMX Controller	400-0469	IP20. DIN Rail system. Is designed for either live or stand-alone control. It features one DMX universe, a USBconnection, 128k flash memory for storing stand-alone programs.

Fagerhult Lighting Ltd

33-34 Dolben Street, SE1 0UQ London, United Kingdom

<https://we-ef.com/uk>

Subject to technical changes and errors. - Generated on 19/04/2025

DMX Controller (smart)

Description	Part ID	Additional information
DMX Controller (smart)	400-0470	IP20. The Touch Panel is an intuitive and easy-to-use keypad or one DMX universe. It can store up to 36 scenes; alternatively, via

**DMX Controller - RDM ready**

Description	Part ID
DMX Controller - RDM ready	400-0471



185-3390

ETC130-GB-CC LED

DMX Controller (smart) - RDM ready

Description	Part ID
DMX Controller (smart) - RDM ready	400-0472



DMX Splitter

Description	Part ID
DMX Splitter	400-0473



185-3390

ETC130-GB-CC LED

we-ef

DMX Booster Box

Description	Part ID
DMX Booster Box for DMX cable system	400-0474



DMX Wireless Repeater

Description	Part ID
DMX Wireless Repeater	400-0477



Fagerhult Lighting Ltd

33-34 Dolben Street, SE1 0UQ London, United Kingdom

<https://we-ef.com/uk>

Subject to technical changes and errors. - Generated on 19/04/2025

185-3390

ETC130-GB-CC LED

we-ef

DMX Wireless Transceiver

Description	Part ID
DMX Wireless Transceiver	400-0476



Fagerhult Lighting Ltd

33-34 Dolben Street, SE1 0UQ London, United Kingdom

<https://we-ef.com/uk>

Subject to technical changes and errors. - Generated on 19/04/2025