



### Description

RGBW/RGBA Colour Changer. IP67\*, Class I. IK10+. Stainless steel construction including PCS hardware. Silicone rubber gasket. Safety glass lens; max. load 5 tonnes. Luminaire can be driven over at low speed. Factory-sealed termination chamber complete with cable gland and 1.5 m of flexible PVC free cable. Cable gland with spiral cable bending protection. Integral EC electronic converter in thermally separated compartment. 'No tool' removable gear/lens tray. CAD-optimised optics for superior illumination and glare control. OLC® One LED Concept. Factory-installed LED circuit board with WE-EF Colour Boost Technology. DMX interface. Gimbal mounted, 360° rotatable and 30° tiltable.

The optional installation blackout is recommended for mounting. To be ordered separately.

Optional with Anti-Slip ceramic Coating ASC to DIN 51130 (Trip Classification 10) available on request.

The luminaire is not suitable for permanent underwater operation and must be switched off in the event of flooding.

\* Additionally tested to IP66, IP67, IP68 0.1 bar 3h, up

|                    |                          |
|--------------------|--------------------------|
| Weight             | 6.20 kg                  |
| Light distribution | symmetric, wide beam [B] |
| Light source       | LED-12/19W - RGBA        |
| CRI                | 20                       |
| Power supply       | EC                       |
| LEDs               | 12                       |
| Rated input power  | 23 W                     |

### Nominal Lumen (lm)

|             |      |
|-------------|------|
| LED Lumen   | 135  |
| Total Lumen | 1620 |
| Tj          | 85   |

### Rated lumens (lm)

|             |        |
|-------------|--------|
| LED Lumen   | 93.6   |
| Total Lumen | 1123.3 |
| Ta          | 25     |

### WE-EF LEUCHTEN GmbH

Töpinger Straße 16, 29646 Bispingen, Germany - Phone: +49 5194 909-0  
info@we-ef.com - <https://we-ef.com>

Subject to technical changes and errors. - Generated on 13/03/2025

**185-3414**

**ETC130-GB-CC LED**

**we-ef**

to 1 m depth according to DIN EN 60598 and IP69K/80°  
according to DIN EN 60529.

**WE-EF LEUCHTEN GmbH**

Töpinger Straße 16, 29646 Bispingen, Germany - Phone: +49 5194 909-0  
info@we-ef.com - <https://we-ef.com>

Subject to technical changes and errors. - Generated on 13/03/2025

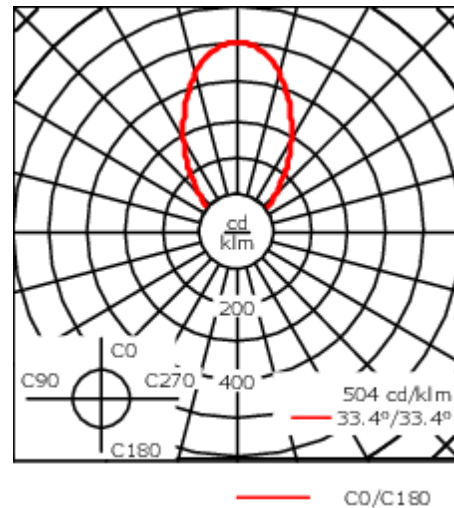
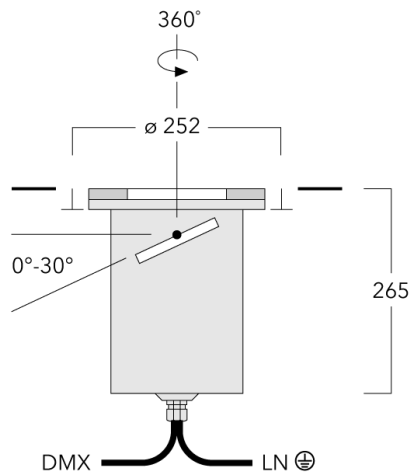

## Specifications

### Material description

|                    |   |
|--------------------|---|
| Body               | Stainless steel construction  |
| Lens               | Safety glass lens; max. load 5 tonnes   |
| Colours            |  Stainless Steel |
| Gasket             | Silicone rubber gasket  |
| Fasteners          | PCS Polymer Coated Stainless Steel Hardware   |
| Ingress protection | IP67  |
| Impact resistance  | IK10+   |

### Electrical description

|                  |                                  |
|------------------|----------------------------------|
| Power supply     | 220-240V / 50-60 Hz              |
| Driver / Ballast | Integral EC electronic converter |
| Power factor     | > 0.9                            |
| Surge protection | 1/2 kV (optional SP10)           |

### Additional information

|                        |                        |
|------------------------|------------------------|
| Lifetime               | Ta=25° L90B10 > 90000h |
| Energieeffizienzklasse | C-D (Light source)     |

#### WE-EF LEUCHTEN GmbH

Töpinger Straße 16, 29646 Bispingen, Germany - Phone: +49 5194 909-0  
 info@we-ef.com - <https://we-ef.com>

Subject to technical changes and errors. - Generated on 13/03/2025

**Mounting Accessories**

**Installation blackout**

| Description       | Part ID  | D1  | D2  | H1  | Weight (kg) | D       | H   |
|-------------------|----------|-----|-----|-----|-------------|---------|-----|
| Blockout, Plastic | 185-0322 | 250 | 270 | 375 | 1.50        | 250/270 | 375 |

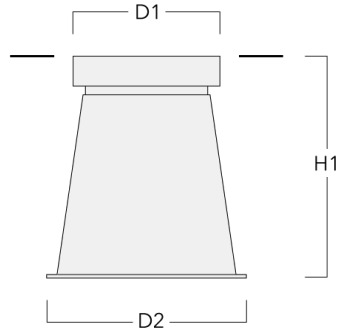

**Installation cover**

| Description           | Part ID  | C1  |
|-----------------------|----------|-----|
| Installation cover BE | 185-0325 | 250 |



**Electrical Accessories**

**Sealable junction box**

| Description                  | Part ID  | C1  | M1   | M2        |
|------------------------------|----------|-----|------|-----------|
| Sealable junction box SJB130 | 185-1624 | 146 | Ø 10 | Ø 12 - 19 |

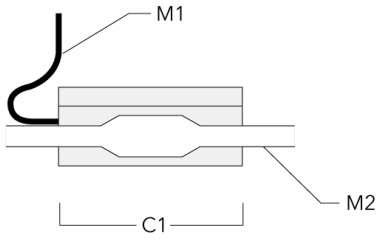

|   |          |     |      |           |
|---|----------|-----|------|-----------|
| Sealable junction box SJB130 (DMX - in/out) | 185-3198 | 146 | Ø 10 | Ø 12 - 19 |
|---|----------|-----|------|-----------|

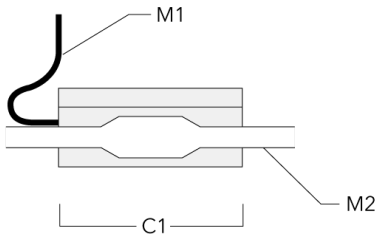

**Control****DMX Wireless Antenna**

| Description     | Part ID  |
|-----------------|----------|
| Antenna RF1.8dB | 430-0018 |

**DMX Motion Sensor**

| Description       | Part ID  |
|-------------------|----------|
| DMX Motion Sensor | 400-0478 |

**DMX Controller**

| Description    | Part ID  | Additional information  |
|----------------|----------|---|
| DMX Controller | 400-0469 | IP20. DIN Rail system. Is designed for either live or stand-alone control. It features one DMX universe, a USBconnection, 128k flash memory for storing stand-alone programs. |

**DMX Controller (smart)**

| Description            | Part ID  | Additional information  |
|------------------------|----------|---|
| DMX Controller (smart) | 400-0470 | IP20. The Touch Panel is an intuitive and easy-to-use keypad or one DMX universe. It can store up to 36 scenes; alternatively, via .... |

**DMX Controller - RDM ready**

| Description                | Part ID  |
|----------------------------|----------|
| DMX Controller - RDM ready | 400-0471 |



185-3414

**ETC130-GB-CC LED**

**DMX Controller (smart) - RDM ready**

---

| Description                        | Part ID  |
|------------------------------------|----------|
| DMX Controller (smart) - RDM ready | 400-0472 |

---



---

**DMX Splitter**

---

| Description  | Part ID  |
|--------------|----------|
| DMX Splitter | 400-0473 |

---



**WE-EF LEUCHTEN GmbH**

Töpinger Straße 16, 29646 Bispingen, Germany - Phone: +49 5194 909-0  
info@we-ef.com - <https://we-ef.com>

Subject to technical changes and errors. - Generated on 13/03/2025



**ETC130-GB-CC LED****DMX Booster Box**

| Description                          | Part ID  |
|--------------------------------------|----------|
| DMX Booster Box for DMX cable system | 400-0474 |

**DMX Wireless Repeater**

| Description           | Part ID  |
|-----------------------|----------|
| DMX Wireless Repeater | 400-0477 |



**185-3414**

**ETC130-GB-CC LED**

**we-ef**

**DMX Wireless Transceiver**

---

| Description              | Part ID  |
|--------------------------|----------|
| DMX Wireless Transceiver | 400-0476 |

---



**WE-EF LEUCHTEN GmbH**

Töpinger Straße 16, 29646 Bispingen, Germany - Phone: +49 5194 909-0  
info@we-ef.com - <https://we-ef.com>

Subject to technical changes and errors. - Generated on 13/03/2025