



Description

Profile Projector [FP] for framing applications, polygon shape. Spherical and aspherical, double flat convex lens system.

IP66, Class I. IK07. Marine-grade, die-cast aluminium alloy. 5CE superior corrosion protection including PCS hardware. Silicone CCG® Controlled Compression Gasket. Safety glass lens. One cable gland. Second gland for through wiring on request. PMMA LED lens array. Factory installed LED circuit board. LED board can be removed for upgrading. Integral EC electronic converter, thermally separated.

Weight	8.20 kg
Light distribution	symmetric Framing-Projector [FP] - min aperture angle
Light source	LED-FT-24W / 700 mA - 3000 K
CRI	80
Power supply	EC
LEDs	1
Rated input power	27 W
Rated lumens (lm)	
LED Lumen	1587.7
Total Lumen	1587.7
Ta	25
Nominal Lumen (lm)	
LED Lumen	3465
Total Lumen	3465
Tc	25



Specifications

Material description

Body	Marine-grade, die-cast aluminium alloy
Lens	Safety glass lens
Colours	<ul style="list-style-type: none"> RAL9004 Signal black RAL9006 White aluminium RAL9007 Grey aluminium RAL7016 Anthracite grey RAL9016 Traffic white
Gasket	Silicone CCG® Controlled Compression Gasket
Fasteners	PCS Polymer Coated Stainless Steel Hardware
Ingress protection	IP66
Impact resistance	IK07
Corrosion resistance	5CE
Windage	0.06 m ²

Electrical description

Power supply	220-240V / 50-60 Hz
Driver / Ballast	Standard. Optional DALI version available. To be specified at time of ordering.
Power factor	> 0.9
Surge protection	6/6 kV (optional SP10)

WE-EF LEUCHTEN GmbH

Töpinger Straße 16, 29646 Bispingen, Germany - Phone: +49 5194 909-0
 info@we-ef.com - <https://we-ef.com>

Subject to technical changes and errors. - Generated on 23/11/2024

139-2130_min

FLC220 LED [FP]

we-ef

Additional information

Lifetime Ta=25° L70B50 > 50000h

Energy efficiency class F (Light source)

WE-EF LEUCHTEN GmbH

Töpinger Straße 16, 29646 Bispingen, Germany - Phone: +49 5194 909-0
info@we-ef.com - <https://we-ef.com>

Subject to technical changes and errors. - Generated on 23/11/2024

Mounting Accessories

Short post EM

Description	Part ID	D1	D2	H1	M1	Weight (kg)
EM1-M16	270-9038	160	130	200	9	2



Floodlight mounting bracket TA

Description	Part ID	A	C1	D x L1	Weight (kg)	D x S
TA1 Mounting bracket, single (Ø 108 x 200)	147-0096		130	108 x 200	7.50	108 x 200



FLC220 LED [FP]

Description	Part ID	A	C1	D × L1	Weight (kg)	D × S
TA2 Mounting bracket, double (Ø 108 x 200)	147-0097		130	108 x 200	7.50	108 x 200



TA2-L Mounting bracket, double (Ø 76 x 200)	147-0105	±90°	420	76 x 200	16.10	76 x 200
---	----------	------	-----	----------	-------	----------

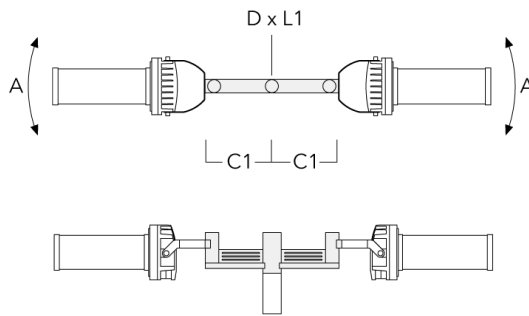

FLC220 LED [FP]

Description	Part ID	A	C1	D × L1	Weight (kg)	D × S
TA3 Mounting bracket, triple (Ø 89 x 200)	147-0025	±90°	650	89 x 200	17.90	89 x 200

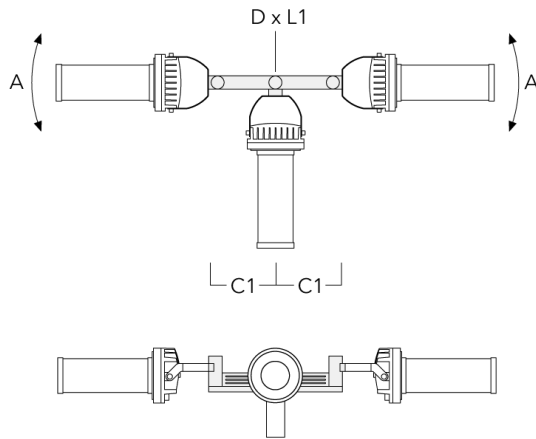

TA3 Mounting bracket, triple (Ø 108 x 200)	147-0098	±90°	650	108 x 200	24.20	108 x 200
--	----------	------	-----	-----------	-------	-----------

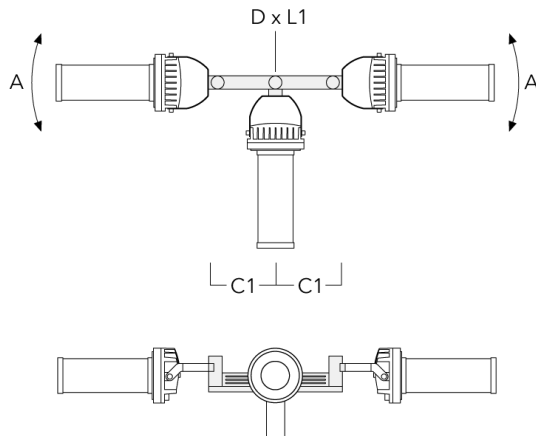

FLC220 LED [FP]

Description	Part ID	A	C1	D x L1	Weight (kg)	D x S
TA4 Mounting bracket, quad (Ø 89 x 200)	147-0099	±90°	650	89 x 200	20.80	89 x 200

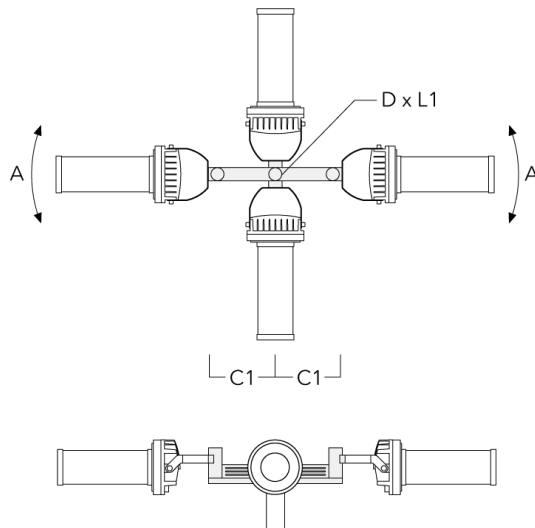

TA4 Mounting bracket, quad (Ø 108 x 200)	147-0100	±90°	650	108 x 200	24.20	108 x 200
--	----------	------	-----	-----------	-------	-----------

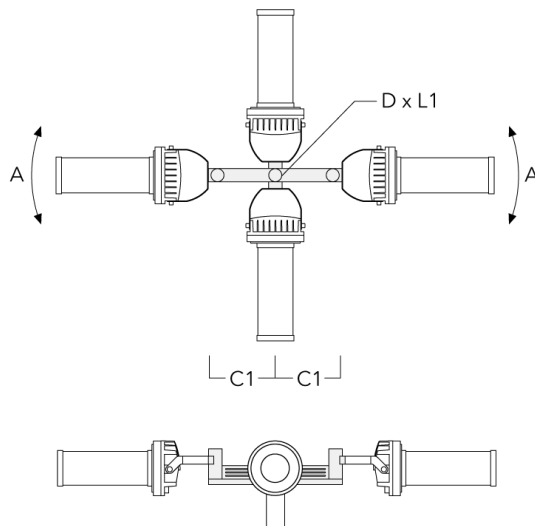

Pole clamp TS

Description	Part ID	D1	Weight (kg)	D
TS1-2/M12 Pole clamp, single (Ø 102-114)	147-0526	102-114	1.50	102-114

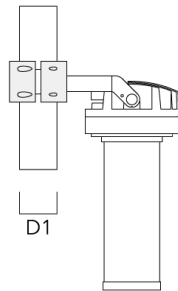
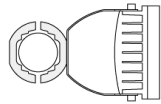

TS1-2/M12 Pole clamp, single (Ø 114-133)	147-0544	114-133	1.70	114-133
--	----------	---------	------	---------

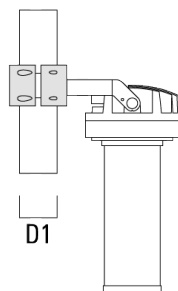
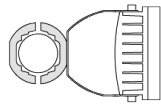

FLC220 LED [FP]

Description	Part ID	D1	Weight (kg)	D
TS2-2/M12 Pole clamp, double (Ø 102-114)	147-0527	102-114	1.50	102-114



TS2-2/M12 Pole clamp, double (Ø 76-89)	147-0545	76-89	1.40	76-89
--	----------	-------	------	-------

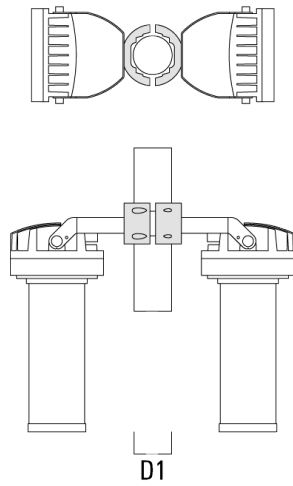

FLC220 LED [FP]

Description	Part ID	D1	Weight (kg)	D
TS2-2/M12 Pole clamp, double (Ø 114-133)	147-0546	114-133	1.60	114-133



TS1-2/M12 Pole clamp, single (Ø 76-89)	147-0543	76-89	1.40	76-89
--	----------	-------	------	-------

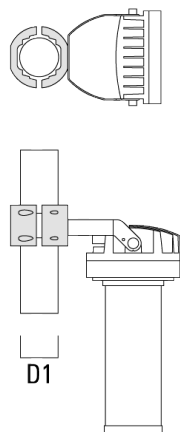

FLC220 LED [FP]

Pole clamp PC

Description	Part ID	D1	Weight (kg)
PC1 76-89/60 Pole clamp, single (Ø 76-89)	139-2702	76-89	1.00

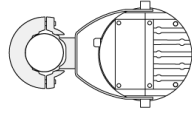

PC2 76-89/60 Pole clamp, double (Ø 76-89)	139-2703	76-89	1.00
---	----------	-------	------



FLC220 LED [FP]

Description	Part ID	D1	Weight (kg)
PC1 82-109/60 Pole clamp, single (Ø 82-109)	139-2704	82-109	1.10



PC2 82-109/60 Pole clamp, double (Ø 82-109)	139-2705	82-109	1.10
---	----------	--------	------



FLC220 LED [FP]

Description	Part ID	D1	Weight (kg)
PC1 102-114/60 Pole clamp, single (Ø 102-114)	139-2706	102-114	1.20



PC2 102-114/60 Pole clamp, double (Ø 102-114)	139-2707	102-114	1.20
--	----------	---------	------

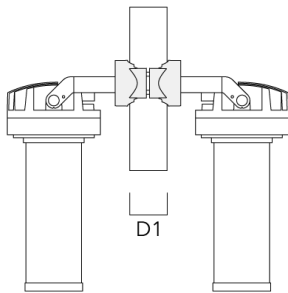

FLC220 LED [FP]

Description	Part ID	D1	Weight (kg)
PC1 114-133/60 Pole clamp, single (Ø 114-133)	139-2708	114-133	1.40



PC2 114-133/60 Pole clamp, double (Ø 114-133)	139-2709	114-133	1.40
--	----------	---------	------



139-2130_min

FLC220 LED [FP]

we-ef

Control

R2C Ready to Connect

Description	Part ID
R2C Ready to Connect (top)	430-0019

WE-EF LEUCHTEN GmbH

Töpinger Straße 16, 29646 Bispingen, Germany - Phone: +49 5194 909-0
info@we-ef.com - <https://we-ef.com>

Subject to technical changes and errors. - Generated on 23/11/2024