

131-9864

SLS410 LED

we-ef



Description

Surface-mounted wall luminaire.

IP66. Class I. IK07. Marine-grade, die-cast aluminum alloy. 5CE superior corrosion protection including PCS hardware. Silicone CCG® Controlled Compression Gasket. Safety glass lens. Two cable entries. CAD-optimized optics for superior illumination and glare control. Integral driver. OLC® One LED Concept. Factory-installed LED circuit board. 0-10V Dimming comes standard with luminaire.

Suitable for Up, Down, or Up/Down light distribution. Supplied with wall plate to fit over 4" recessed junction box.

Specify product with 7 Digit product code - Finish Color. Accessories, such as mounting, optical, and electrical, must be specified separately.

Example: XXX-XXXX-9004 (Black)
+ XXX-XXXX (Accessory 1)

Weight	7.34 lb
Light distribution	symmetric, medium beam up and down [M/M]
Light source	LED-2x3/18W / 1050mA - 3000 K
CRI	80
Power supply	electronic gear
BUG	B1 U0 G0 Down Only
LEDs	6
Rated input power	22 W

Nominal Lumen (lm)

LED Lumen	430
Total Lumen	2580
Tj	85

Rated lumens (lm)

LED Lumen	289.9
Total Lumen	1739.5
Ta	25

WE-EF LIGHTING USA, LLC

410-D Keystone Drive, 15086 Warrendale, PA 15086 - Phone: +1 724 742 0030
customersupport.usa@we-ef.com - <https://we-ef.com/us>
Subject to technical changes and errors. - Generated on 11/23/2024

131-9864



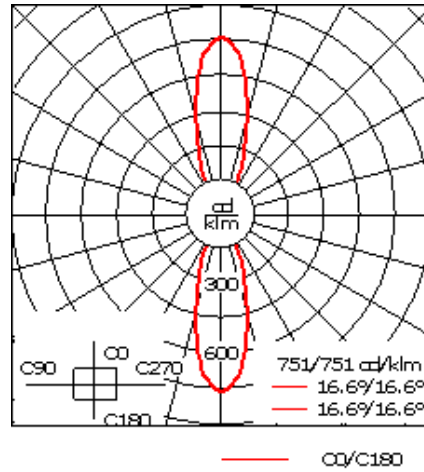
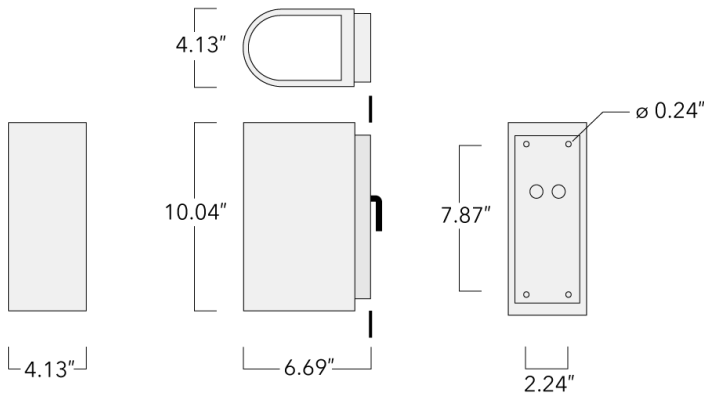

SLS410 LED

we-ef



Specifications

Material description

Body	Marine-grade, die-cast aluminium alloy
Lens	Safety glass lens
Colors	<ul style="list-style-type: none">  RAL9004 Black  RAL9007 Grey Metallic  RAL9016 White  RAL8019 Dark Bronze
Gasket	Silicone rubber gasket
Fasteners	PCS hardware
Ingress protection	IP66
Impact resistance	IK07
Corrosion resistance	5CE

Electrical description

Power supply	Integral [ECG] electronic 0-10 V dimmable driver in 120-277 universal voltage.
Driver / Ballast	Integral EC electronic converter

WE-EF LIGHTING USA, LLC

410-D Keystone Drive, 15086 Warrendale, PA 15086 - Phone: +1 724 742 0030

customersupport.usa@we-ef.com - <https://we-ef.com/us>

Subject to technical changes and errors. - Generated on 11/23/2024

131-9864

SLS410 LED

we-ef

Additional information

Lifetime	Ta=25°/40° L90B10 > 90000h
BUG Rating	Please see individual Spec Sheets for classification of Backlight, Uplight and Glare.
Listings	ETL listed. Suitable for wet locations.

WE-EF LIGHTING USA, LLC

410-D Keystone Drive, 15086 Warrendale, PA 15086 - Phone: +1 724 742 0030
customersupport.usa@we-ef.com - <https://we-ef.com/us>

Subject to technical changes and errors. - Generated on 11/23/2024

Mounting Accessories

Column fitter

Description	Part ID	C1	D1	H1	H2	M1	Weight (lb)
CF-410/420	131-9140	3.27	≥ 5.51	8.66	3.94	0.24	1.32

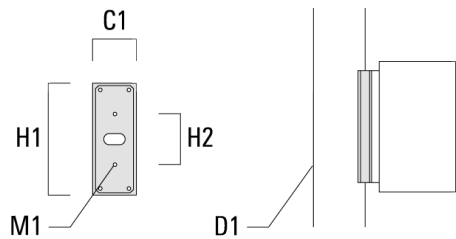

Surface Collar

Description	Part ID	A	B	C1	D1	D2	D3	M1	M2
VLS/SLS Surface Collar	131-6004	8.66	3.66	1.75	∅1	∅1.5	∅0.38	6	2

