

131-9805

SLS420 LED

we-ef



Description

Surface-mounted wall luminaire.

IP66. Class I. IK07.

Marine-grade, die-cast aluminum alloy. 5CE superior corrosion protection including PCS hardware. Silicone CCG® Controlled Compression Gasket. Safety glass lens. Two cable entries. CAD-optimized optics for superior illumination and glare control. Integral driver. OLC® One LED Concept. Factory-installed LED circuit board. 0-10V Dimming comes standard with luminaire.

Suitable for Up, Down, or Up/Down light distribution.
Suitable for installation over 4" recessed junction box.
Emergency Lighting Package option available; to be specified as accessory with order.

Specify product with 7 Digit product code - Finish Color.
Accessories, such as mounting, optical, and electrical, must be specified separately.

Example: XXX-XXXX-9004 (Black)
+ XXX-XXXX (Accessory 1)

For DarkSky compliant configurations of this product,

Weight	10.80 lb
Light distribution	symmetric, medium beam up and down [M/M]
Light source	LED-2x6/36W / 1050 mA - 4000 K
CRI	80
Power supply	electronic gear
BUG	B2 U0 G0 Down Only
LEDs	12
Rated input power	41 W

Nominal Lumen (lm)

LED Lumen	450
Total Lumen	5400
Tj	85

Rated lumens (lm)

LED Lumen	303.4
Total Lumen	3640.7
Ta	25

WE-EF LIGHTING USA, LLC

410-D Keystone Drive, 15086 Warrendale, PA 15086 - Phone: +1 724 742 0030
customersupport.usa@we-ef.com - <https://we-ef.com/us>
Subject to technical changes and errors. - Generated on 11/23/2024

131-9805

SLS420 LED

we-ef

please find the spec sheet and DarkSky certificate in the library.

WE-EF LIGHTING USA, LLC

410-D Keystone Drive, 15086 Warrendale, PA 15086 - Phone: +1 724 742 0030
customersupport.usa@we-ef.com - <https://we-ef.com/us>

Subject to technical changes and errors. - Generated on 11/23/2024

131-9805

SLS420 LED

we-ef

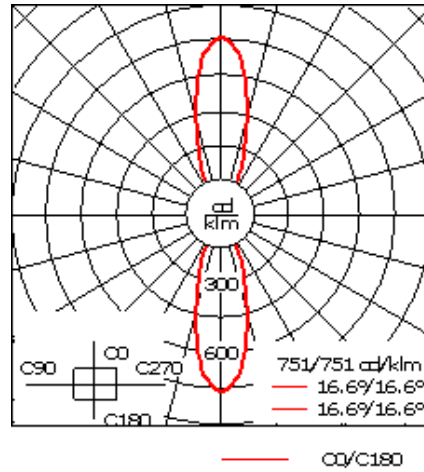
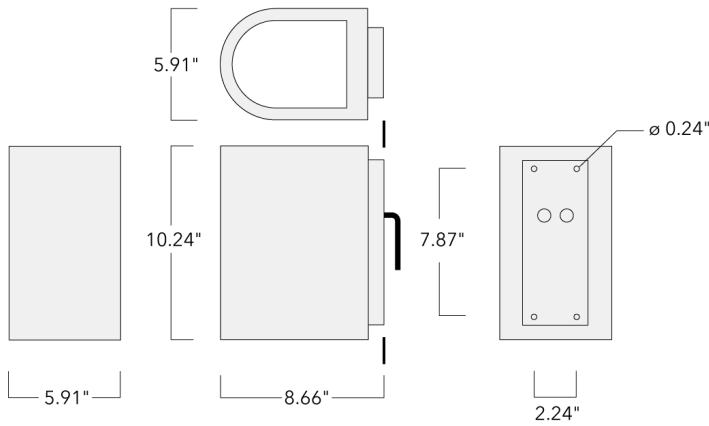

Specifications

Material description

Body	Marine-grade, die-cast aluminium alloy
Lens	Safety glass lens
Colors	<ul style="list-style-type: none"> RAL9004 Black RAL9007 Grey Metallic RAL9016 White RAL8019 Dark Bronze
Gasket	Silicone rubber gasket
Fasteners	PCS hardware
Ingress protection	IP66
Impact resistance	IK07
Corrosion resistance	5CE

Electrical description

Power supply	Integral [ECG] electronic 0-10 V dimmable driver in 120-277 universal voltage.
Driver / Ballast	Integral EC electronic converter

Additional information

Lifetime	Ta=25°/40° L90B10 > 90000h
BUG Rating	Please see individual Spec Sheets for classification of Backlight, Uplight and Glare.
Listings	ETL listed. Suitable for wet locations.

WE-EF LIGHTING USA, LLC

410-D Keystone Drive, 15086 Warrendale, PA 15086 - Phone: +1 724 742 0030

customersupport.usa@we-ef.com - <https://we-ef.com/us>

Subject to technical changes and errors. - Generated on 11/23/2024

Mounting Accessories

Column fitter

Description	Part ID	C1	D1	H1	H2	M1	Weight (lb)
CF-410/420	131-9140	3.27	≥ 5.51	8.66	3.94	0.24	1.32

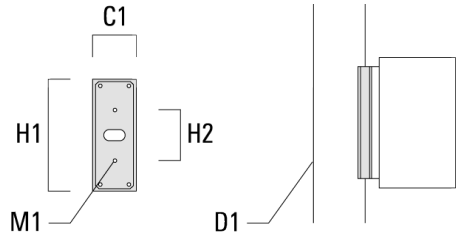

Surface Collar

Description	Part ID	A	B	C1	D1	D2	D3	M1	M2
VLS/SLS Surface Collar	131-6004	8.66	3.66	1.75	∅1	∅1.5	∅0.38	6	2

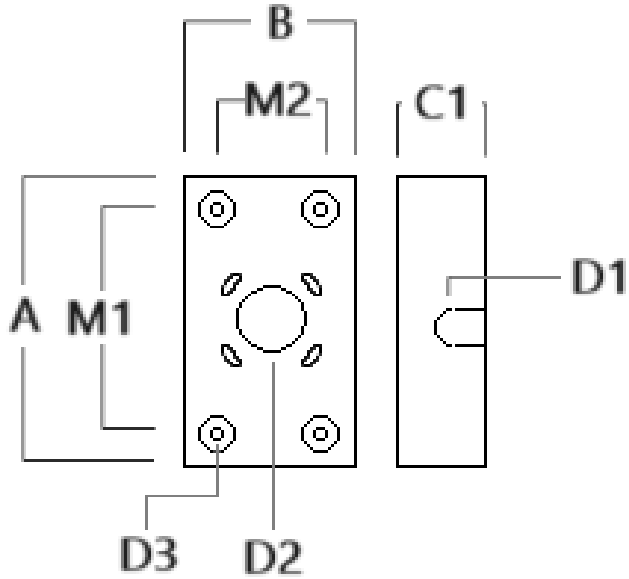

131-9805

SLS420 LED

we-ef

Electrical Accessories

Emergency Lighting Package

Description	Part ID	Additional information
_LS420/430 LED Emergency Lighting Package	131-6900	Emergency battery backup operating for a minimum 90 minutes when power is lost.

WE-EF LIGHTING USA, LLC

410-D Keystone Drive, 15086 Warrendale, PA 15086 - Phone: +1 724 742 0030
customersupport.usa@we-ef.com - <https://we-ef.com/us>

Subject to technical changes and errors. - Generated on 11/23/2024