

111-0192

RFL530-SE LED

we-ef



Description

Wall and pole mounted luminaire.

IP66. Class I. IK07. Marine-grade, die-cast aluminum alloy. 5CE superior corrosion protection including PCS hardware. Silicone CCG® Controlled Compression Gasket. Non-reflecting safety glass lens hinged, tool-less entry. CAD-optimized optics for superior illumination and glare control. Integral driver in thermally separated compartment. OLC® One LED Concept. Factory-installed LED circuit board. 0-10V Dimming comes standard with luminaire. Luminaire is factory-sealed and does not need to be opened during installation.

Recommended mounting height 10-20 ft, depending on wattage and light distribution selected.

Specify product with 7 Digit product code - Finish Color. Accessories, such as mounting, optical, and electrical, must be specified separately.

Example: XXX-XXXX-9004 (Black)
+ XXX-XXXX (Accessory 1)

Weight	21.00 lb
Light distribution	[S60] Type III Short
Light source	LED-12/24W / 700 mA - 3000 K
CRI	80
Power supply	electronic gear
BUG	B1 U0 G1
LEDs	12
Rated input power	27 W

Nominal Lumen (lm)

LED Lumen	290
Total Lumen	3480
Tj	85

Rated lumens (lm)

LED Lumen	260.6
Total Lumen	3126.9
Ta	25

WE-EF LIGHTING USA, LLC

410-D Keystone Drive, 15086 Warrendale, PA 15086 - Phone: +1 724 742 0030
customersupport.usa@we-ef.com - <https://we-ef.com/us>
Subject to technical changes and errors. - Generated on 11/23/2024

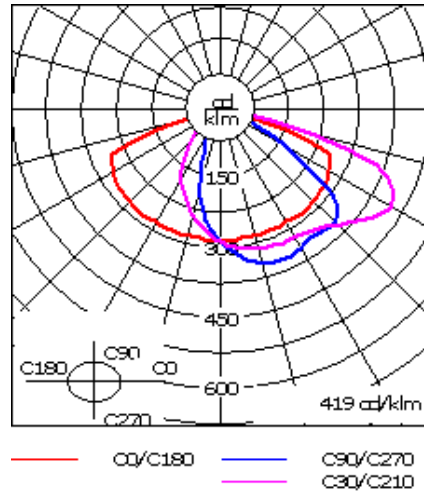
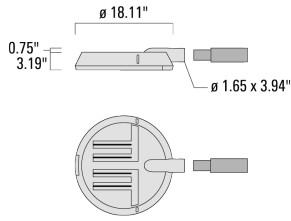

Specifications

Material description

Body	Marine-grade, die-cast aluminium alloy
Lens	Non-reflecting safety glass lens, hinged
Colors	<div style="display: flex; flex-direction: column; gap: 5px;"> <div> RAL9004 Black</div> <div> RAL9007 Grey Metallic</div> <div> RAL9016 White</div> <div> RAL8019 Dark Bronze</div> </div>
Gasket	Silicone CCG® Controlled Compression Gasket
Fasteners	PCS Polymer Coated Stainless Steel Hardware
Ingress protection	IP66
Impact resistance	IK07
Corrosion resistance	5CE
Windage	0.3 ft ²

Electrical description

Power supply	Integral [ECG] electronic driver 120V-277V. 0-10V dimmable, to be specified with order.
Driver / Ballast	Integral EC electronic converter
Power factor	> 0.9
Surge protection	In-line bracket 10kV Surge Protector

WE-EF LIGHTING USA, LLC

410-D Keystone Drive, 15086 Warrendale, PA 15086 - Phone: +1 724 742 0030
 customersupport.usa@we-ef.com - <https://we-ef.com/us>
 Subject to technical changes and errors. - Generated on 11/23/2024

111-0192

we-ef

RFL530-SE LED

Additional information

Lifetime	Ta=25°/40° L90B10 > 90000h
BUG Rating	Please see individual Spec Sheets for classification of Backlight, Uplight and Glare.
Listings	ETL, UL-1598, CSA-C22.2#250.0. Suitable for Wet Locations.

WE-EF LIGHTING USA, LLC

410-D Keystone Drive, 15086 Warrendale, PA 15086 - Phone: +1 724 742 0030
customersupport.usa@we-ef.com - <https://we-ef.com/us>
Subject to technical changes and errors. - Generated on 11/23/2024

Mounting Accessories

Wall and pole brackets RE

Description	Part ID	C1	D1	D2	D x L1	H1	L	M1	Weight (lb)	C	H
RE0-530 Wall bracket	111-0052	7.09	9.06	7.68				0.47	6.39	120	

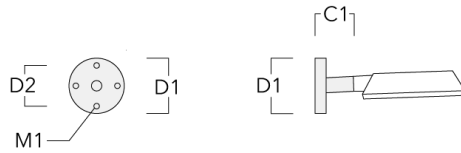

RE1-530 Pole bracket, single	111-0040	7.09			3 x 3	15.75	2.99	7.05		180	400
------------------------------	----------	------	--	--	-------	-------	------	------	--	-----	-----

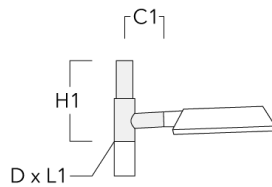

RFL530-SE LED

Description	Part ID	C1	D1	D2	D × L1	H1	L	M1	Weight (lb)	C	H
RE2-530 Pole bracket, double	111-0041	7.09			3 x 3	15.75	2.99		7.94	180	400

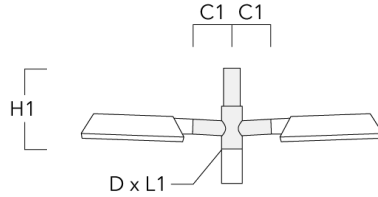

Pole brackets RF

Description	Part ID	C1	D × L1	H1	L	Weight (lb)	C	H
RF1-530 Pole bracket, single	111-0044	7.48	3 x 3	10.83	2.99	5.07	190	275

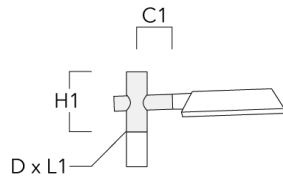

WE-EF LIGHTING USA, LLC

410-D Keystone Drive, 15086 Warrendale, PA 15086 - Phone: +1 724 742 0030

customersupport.usa@we-ef.com - <https://we-ef.com/us>

Subject to technical changes and errors. - Generated on 11/23/2024

RFL530-SE LED

Description	Part ID	C1	D × L1	H1	L	Weight (lb)	C	H
RF2-530 Pole bracket, double	111-0045	7.48	3 x 3	10.83	2.99	6.61	190	275

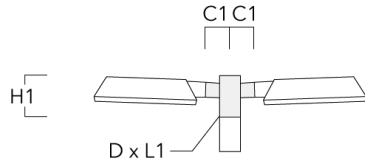

Wall and pole brackets RI

Description	Part ID	C1	D1	D × L1	H1	L	Weight (lb)
RI0-530 Adjustable wall and pole bracket	111-0178	7.24-10"	3-5.25"		5"		4.08 lbs

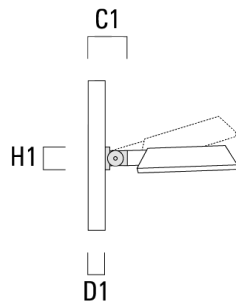

WE-EF LIGHTING USA, LLC

410-D Keystone Drive, 15086 Warrendale, PA 15086 - Phone: +1 724 742 0030

customersupport.usa@we-ef.com - <https://we-ef.com/us>

Subject to technical changes and errors. - Generated on 11/23/2024

RFL530-SE LED

Description	Part ID	C1	D1	D × L1	H1	L	Weight (lb)
R11-530 Adjustable pole bracket, single	106-0454	7.68"		3 x 3	18.70"		10.00 lbs

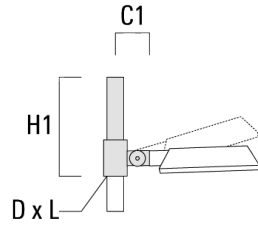

R12-530 Adjustable pole bracket, double	106-0455	7.68"		3 x 3	18.70"	2.99"	13.00 lbs
--	----------	-------	--	-------	--------	-------	-----------

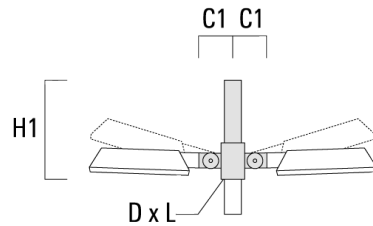

WE-EF LIGHTING USA, LLC

410-D Keystone Drive, 15086 Warrendale, PA 15086 - Phone: +1 724 742 0030
 customersupport.usa@we-ef.com - <https://we-ef.com/us>

Subject to technical changes and errors. - Generated on 11/23/2024

Wall and pole brackets RX

Description	Part ID	C1	D1	D2	D × L1	H1	H2	M1	M2	Weight (lb)
RX0-530 Wall bracket	111-0053	27.95	5.51	3.94		13.78	11.22	1.18	0.47	7.28

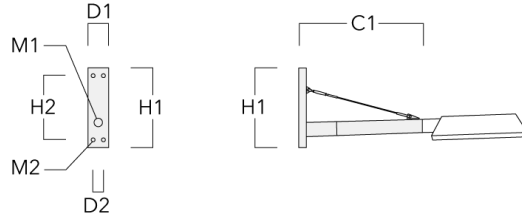

RX1-530 Pole bracket, single	111-0088	27.95			3 x 3	15.75				9.92
------------------------------	----------	-------	--	--	-------	-------	--	--	--	------

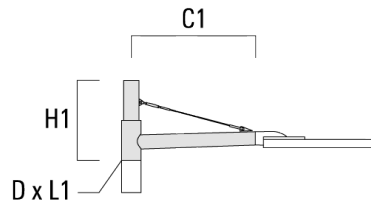

RFL530-SE LED

Description	Part ID	C1	D1	D2	D x L1	H1	H2	M1	M2	Weight (lb)
RX2-530 Pole bracket, double	111-0089	27.95			3 x 3	15.75				13.67

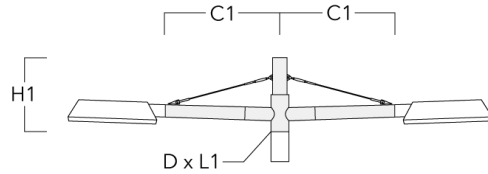

Tilt brackets TB

Description	Part ID	A	D1	D2	L	Weight (lb)
TB-530.42-10 Tilt bracket 10°	111-0639	10°	1.65 x 3.54	1.65 x 3.94	8.07"	1.10

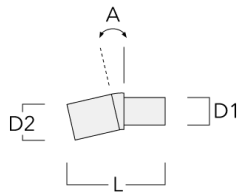

WE-EF LIGHTING USA, LLC

410-D Keystone Drive, 15086 Warrendale, PA 15086 - Phone: +1 724 742 0030
 customersupport.usa@we-ef.com - <https://we-ef.com/us>
 Subject to technical changes and errors. - Generated on 11/23/2024

RFL530-SE LED

Description	Part ID	A	D1	D2	L	Weight (lb)
TB-530.42-15 Tilt bracket 15°	111-0640	15°	1.65 x 3.54	1.65 x 3.94	8.07"	1.10

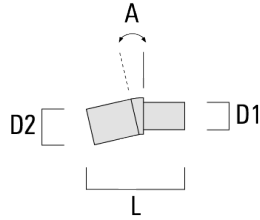

Pole clamp SI

Description	Part ID	C1	D1	Weight (lb)	C	D
SI1-530 Pole clamp, single (Ø 3"-3.5")	111-0066			195	76 - 89	

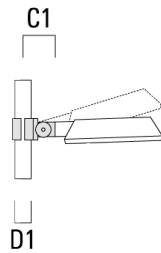

WE-EF LIGHTING USA, LLC

410-D Keystone Drive, 15086 Warrendale, PA 15086 - Phone: +1 724 742 0030
 customersupport.usa@we-ef.com - <https://we-ef.com/us>
 Subject to technical changes and errors. - Generated on 11/23/2024

RFL530-SE LED

Description	Part ID	C1	D1	Weight (lb)	C	D
SI1-530 Pole clamp, single (Ø 4"-4.5")	111-0067	7.68"	4.0"-4.5"	195	102 - 114	

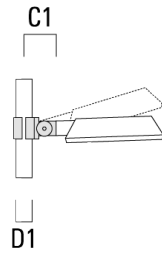

SI1-530 Pole clamp, single (Ø 4.5"-5.25")	111-0176	7.68"	4.50"-5.25"	195	114 - 133	
---	----------	-------	-------------	-----	-----------	--

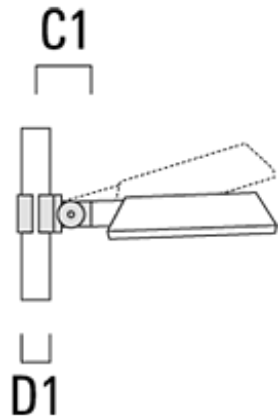

WE-EF LIGHTING USA, LLC

410-D Keystone Drive, 15086 Warrendale, PA 15086 - Phone: +1 724 742 0030
 customersupport.usa@we-ef.com - <https://we-ef.com/us>
 Subject to technical changes and errors. - Generated on 11/23/2024

RFL530-SE LED

Description	Part ID	C1	D1	Weight (lb)	C	D
SI2-530 Pole clamp, double (Ø 3"-3.5")	111-0068	7.68"	3.0"-3.5"	9.00 lbs	195	76 - 89

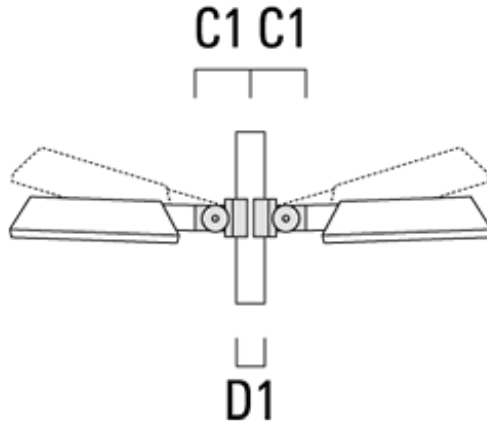

SI2-530 Pole clamp, double (Ø 4"-4.5")	111-0069	7.68"	4.0"-4.5"	11.00 lbs	195	102 - 114
--	----------	-------	-----------	-----------	-----	-----------

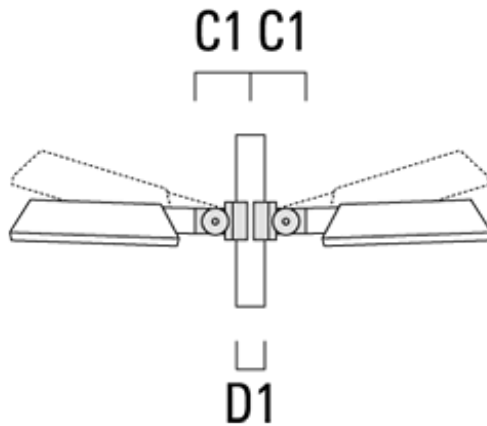

WE-EF LIGHTING USA, LLC

410-D Keystone Drive, 15086 Warrendale, PA 15086 - Phone: +1 724 742 0030
 customersupport.usa@we-ef.com - <https://we-ef.com/us>
 Subject to technical changes and errors. - Generated on 11/23/2024

111-0192

we-ef

RFL530-SE LED

Description	Part ID	C1	D1	Weight (lb)	C	D
SI2-530 Pole clamp, double (Ø 4.5"-5.25")	111-0182	7.68"	4.50"-5.25"	12.00	195	114 - 133

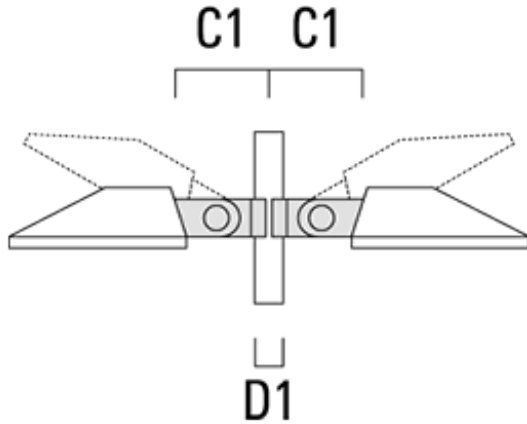

WE-EF LIGHTING USA, LLC

410-D Keystone Drive, 15086 Warrendale, PA 15086 - Phone: +1 724 742 0030
customersupport.usa@we-ef.com - <https://we-ef.com/us>
Subject to technical changes and errors. - Generated on 11/23/2024

Optical Accessories

Light shield

Description	Part ID	Additional information
LS180-[A60]	430-0038	Light shield LS180 to greatly reduce or eliminate light pollution. PA injection moulded component, black matt. Suitable for asymmetric light distribution [A60].
LS180	430-0029	Glare Shield for backlight spill. Glare Shield factory-installed or available as retrofit kit. Suitable for [S60], [S65], [S70], [R65], [P65] lenses. Must be specified at time of ordering.