

131-9982

RLS420 LED

we-ef



Description

Surface-mounted wall or ceiling luminaire.

ADA (American Disabilities Act) Compliant.

IP66. Class I. IK08. Marine-grade, die-cast aluminum alloy. 5CE superior corrosion protection including PCS hardware. Silicone CCG® Controlled Compression Gasket. Safety glass lens. CAD-optimized optics for superior illumination and glare control. Integral driver. OLC® One LED Concept. Advanced thermal management protects LEDs while optimizing lumens output. 0-10V Dimming comes standard with luminaire. Luminaire is factory-sealed and does not need to be opened during installation.

Luminaire can be mounted for up or down lighting. Suitable for installation on ceiling or wall over 4" recessed junction box.

Specify product with 7 Digit product code - Finish Color. Accessories, such as mounting, optical, and electrical, must be specified separately.

Example: XXX-XXXX-9004 (Black)
+ XXX-XXXX (Accessory 1)

Weight	5.73 lb
Light distribution	rectangular asymmetric Type II [R45]
Light source	LED-6/18W / 1050 mA - 3000 K
CRI	80
Power supply	electronic gear
BUG	B0 U0 G0
LEDs	6
Rated input power	21 W

Nominal Lumen (lm)

LED Lumen	430
Total Lumen	2580
Tj	85

Rated lumens (lm)

LED Lumen	256.7
Total Lumen	1540.2
Ta	25

WE-EF LIGHTING USA, LLC

410-D Keystone Drive, 15086 Warrendale, PA 15086 - Phone: +1 724 742 0030
customersupport.usa@we-ef.com - <https://we-ef.com/us>
Subject to technical changes and errors. - Generated on 11/23/2024

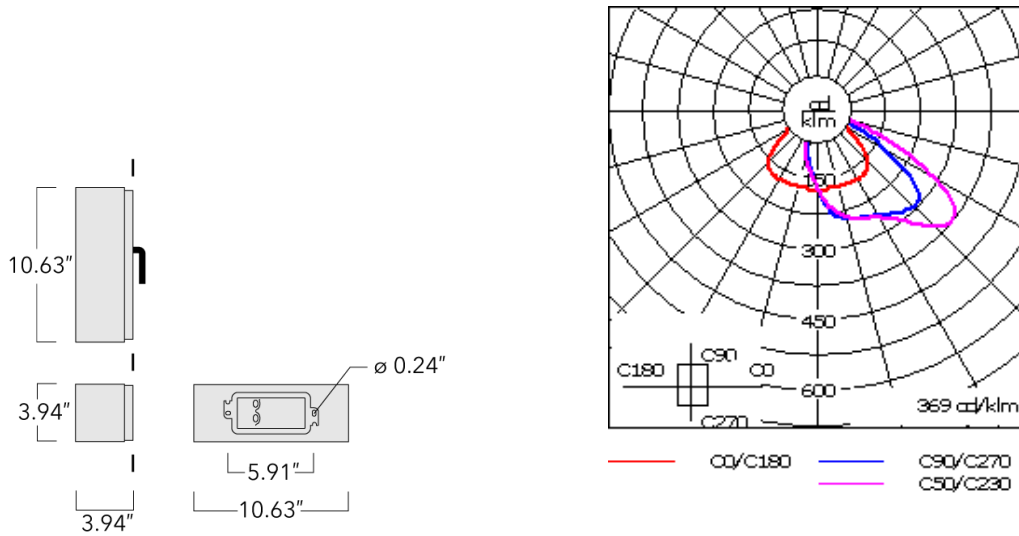

Specifications

Material description

Body	Marine-grade, die-cast aluminium alloy
Lens	Safety glass lens
Colors	<div style="display: flex; flex-direction: column; gap: 5px;"> <div style="display: flex; align-items: center;"> <div style="width: 20px; height: 10px; background-color: black; margin-right: 5px;"></div> RAL9004 Black </div> <div style="display: flex; align-items: center;"> <div style="width: 20px; height: 10px; background-color: grey; margin-right: 5px;"></div> RAL9007 Grey Metallic </div> <div style="display: flex; align-items: center;"> <div style="width: 20px; height: 10px; background-color: white; margin-right: 5px;"></div> RAL9016 White </div> <div style="display: flex; align-items: center;"> <div style="width: 20px; height: 10px; background-color: darkgrey; margin-right: 5px;"></div> RAL8019 Dark Bronze </div> </div>
Gasket	Silicone CCG® Controlled Compression Gasket
Fasteners	PCS Polymer Coated Stainless Steel Hardware
Ingress protection	IP66
Impact resistance	IK08
Corrosion resistance	5CE

Electrical description

Power supply	Integral [ECG] electronic driver 120V-277V. 0-10V dimmable, to be specified with order.
Driver / Ballast	Standard. Optional DALI version available. To be specified at time of ordering.

WE-EF LIGHTING USA, LLC

410-D Keystone Drive, 15086 Warrendale, PA 15086 - Phone: +1 724 742 0030
 customersupport.usa@we-ef.com - <https://we-ef.com/us>
 Subject to technical changes and errors. - Generated on 11/23/2024

131-9982

RLS420 LED

we-ef

Additional information

Lifetime	Ta=25°/40° L90B10 > 90000h
BUG Rating	Please see individual Spec Sheets for classification of Backlight, Uplight and Glare.
Listings	ETL listed. Suitable for wet locations.

WE-EF LIGHTING USA, LLC

410-D Keystone Drive, 15086 Warrendale, PA 15086 - Phone: +1 724 742 0030
customersupport.usa@we-ef.com - <https://we-ef.com/us>
Subject to technical changes and errors. - Generated on 11/23/2024

131-9982

RLS420 LED

we-ef

Optical Accessories

Colour correction filter

Description	Part ID
IF-3000K > 2400K	131-9707

Honeycomb louvre

Description	Part ID
Honeycomb louvre IW	131-9706

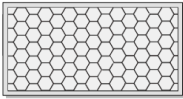

WE-EF LIGHTING USA, LLC

410-D Keystone Drive, 15086 Warrendale, PA 15086 - Phone: +1 724 742 0030
customersupport.usa@we-ef.com - <https://we-ef.com/us>

Subject to technical changes and errors. - Generated on 11/23/2024

131-9982

RLS420 LED

we-ef

Mounting Accessories

Surface Collar

Description	Part ID	A	B	C1	D1	D2	D3	M1	M2
RLS420 Surface Collar	131-6003	3.94	10.63	1.75	∅1	∅1.75	∅0.38	2.75	9.29

WE-EF LIGHTING USA, LLC

410-D Keystone Drive, 15086 Warrendale, PA 15086 - Phone: +1 724 742 0030
customersupport.usa@we-ef.com - <https://we-ef.com/us>

Subject to technical changes and errors. - Generated on 11/23/2024