



Description

IP66, Class I. Class II on request. IK07. Marine-grade, die-cast aluminium alloy. 5CE superior corrosion protection including PCS hardware. Silicone CCG® Controlled Compression Gasket. Safety glass lens. Integral EC electronic converter in thermally separated compartment. CAD-optimised optics for superior illumination and glare control. OLC® One LED Concept. Factory installed LED circuit board. The luminaire is factory- sealed and does not need to be opened during the installation.

Optional 2200 K version available. To be specified at time of ordering.

Weight	1.70 kg
Light distribution	symmetric, medium beam [M]
Light source	LED-6/12W / 700 mA - 2700 K
CRI	80
Power supply	EC
LEDs	6
Rated input power	14.5 W
Nominal Lumen (lm)	
LED Lumen	270
Total Lumen	1620
Tj	85
Rated lumens (lm)	
LED Lumen	234.6
Total Lumen	1407.5
Ta	25

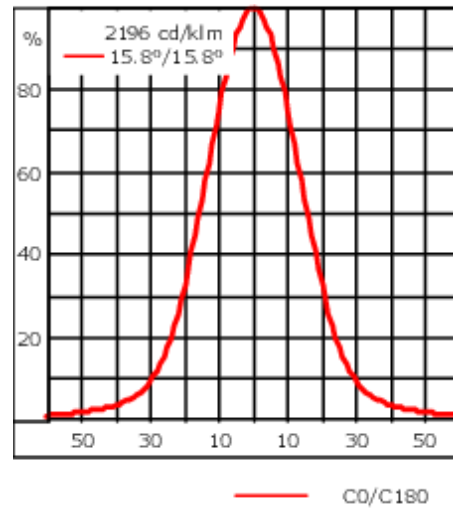
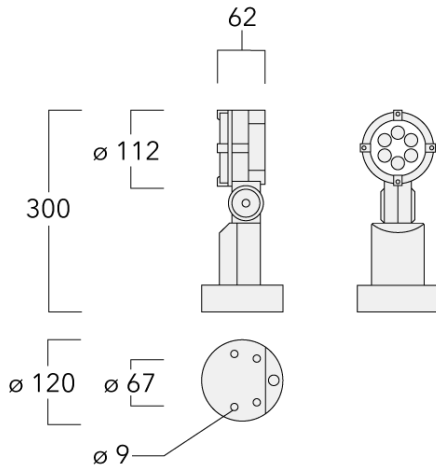

Specifications
Material description

Body	Marine-grade, die-cast aluminium alloy
Lens	Safety glass lens
Colours	<div style="display: flex; align-items: center; margin-bottom: 5px;"> <div style="width: 20px; height: 15px; background-color: black; margin-right: 5px;"></div> RAL9004 Signal black </div> <div style="display: flex; align-items: center; margin-bottom: 5px;"> <div style="width: 20px; height: 15px; background-color: #cccccc; margin-right: 5px;"></div> RAL9006 White aluminium </div> <div style="display: flex; align-items: center; margin-bottom: 5px;"> <div style="width: 20px; height: 15px; background-color: #808080; margin-right: 5px;"></div> RAL9007 Grey aluminium </div> <div style="display: flex; align-items: center; margin-bottom: 5px;"> <div style="width: 20px; height: 15px; background-color: #333333; margin-right: 5px;"></div> RAL7016 Anthracite grey </div> <div style="display: flex; align-items: center;"> <div style="width: 20px; height: 15px; background-color: #e0e0e0; margin-right: 5px;"></div> RAL9016 Traffic white </div>
Gasket	Silicone CCG® Controlled Compression Gasket
Fasteners	PCS Polymer Coated Stainless Steel Hardware
Ingress protection	IP66
Impact resistance	IK07
Corrosion resistance	5CE
Windage	0.025 m ²

145-0283

FLC121 LED

we-ef

Electrical description

Power supply	220-240V / 50-60 Hz
Driver / Ballast	Integral EC electronic converter in thermally-separated compartment
Surge protection	1/2 kV

Additional information

Lifetime	Ta=25° L90B10 > 90000h
Energy efficiency class	C-D (Light source)

145-0283

FLC121 LED

we-ef

Optical Accessories

Snoot

Description	Part ID	A	C1
Snoot ET	145-0030	60	120



Linear spread lens

Description	Part ID	C1
IO-180-FLC121-LED	145-0050	81



Fagerhult Lighting Ltd

33-34 Dolben Street, SE1 0UQ London, United Kingdom

<https://we-ef.com/uk>

Subject to technical changes and errors. - Generated on 23/11/2024

145-0283

FLC121 LED

we-ef

Flood lens

Description	Part ID	C1
IO-360-FLC121-LED	145-0142	81

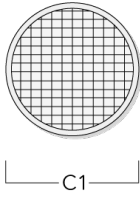

Honeycomb louvre

Description	Part ID	C1
IW-FLC121-LED - [EE][EES]	145-0143	81



145-0283

FLC121 LED

we-ef

Wallwash lens

Description	Part ID	C1
IO-20-WW-FLC121-LED	145-0145	81



Glare shield

Description	Part ID	A	C1
Glare shield ES	145-9192	102	119



Fagerhult Lighting Ltd

33-34 Dolben Street, SE1 0UQ London, United Kingdom

<https://we-ef.com/uk>

Subject to technical changes and errors. - Generated on 23/11/2024

Mounting Accessories

Pipe clamp SP

Description	Part ID	D1	Weight (kg)	D
SP1-2/M8 Pole clamp, single (Ø 76-89)	146-0246	76-89	1.20	76-89

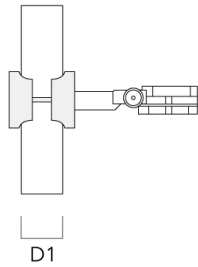

SP2-2/M8 Pole clamp, double (Ø 38-60)	146-0247	38-60	1	38-66
---------------------------------------	----------	-------	---	-------



145-0283

FLC121 LED

we-ef

Description	Part ID	D1	Weight (kg)	D
SP2-2/M8 Pole clamp, double (Ø 76-89)	146-0248	76-89	1.20	76-89



SP1-2/M8 Pole clamp, single (Ø 38-60)	146-0245	38-60	1	38-66
---------------------------------------	----------	-------	---	-------

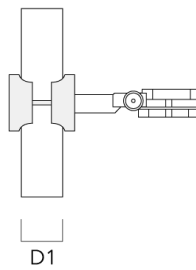

Fagerhult Lighting Ltd

33-34 Dolben Street, SE1 0UQ London, United Kingdom

<https://we-ef.com/uk>

Subject to technical changes and errors. - Generated on 23/11/2024

Short post EM

Description	Part ID	D1	D2	H1	M1	Weight (kg)
EM1-2/M8	146-0253	160	130	200	9	1.10



Ground spike EF

Description	Part ID	H1	Weight (kg)
Ground spike EF1-2/M8	146-0251	270	0.40

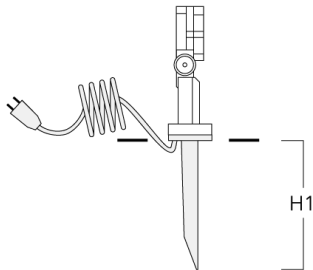

145-0283

FLC121 LED

we-ef

Planted root

Description	Part ID	D1	D2	D3	D4	H1	H2	M1	Weight(kg)
Planted root ESV4	300-0461	145	130	102	108	400	350	8	7.85

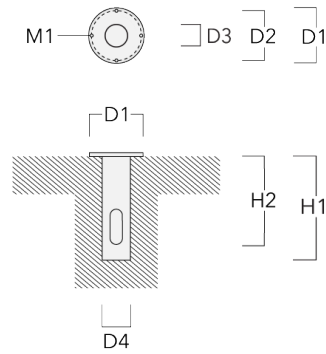

Junction box JB1

Description	Part ID	D1	D2	M1	Weight(kg)
JB1 Junction box	310-9000	135	67	9	1.6

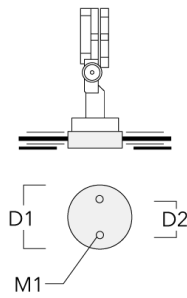

Fagerhult Lighting Ltd

33-34 Dolben Street, SE1 0UQ London, United Kingdom

<https://we-ef.com/uk>

Subject to technical changes and errors. - Generated on 23/11/2024