



Description

IP66, Class I. IK07. Marine-grade, die-cast aluminium alloy. 5CE superior corrosion protection including PCS hardware. Safety glass lens. Silicone CCG® Controlled Compression Gasket.

Integral EC electronic converter in thermally-separated compartment. Advanced thermal management protects LEDs while optimising lumens output. CAD-optimised optics for superior illumination and glare control. OLC® One LED Concept.

Weight	1.70 kg
Light distribution	symmetric, medium beam [M]
Light source	LED-6/12W / 700 mA - 2700 K
CRI	80
Power supply	EC
LEDs	6
Rated input power	14.5 W
Nominal Lumen (lm)	
LED Lumen	270
Total Lumen	1620
Tj	85
Rated lumens (lm)	
LED Lumen	234.6
Total Lumen	1407.5
Ta	25

FLC121 LED Surface mounted

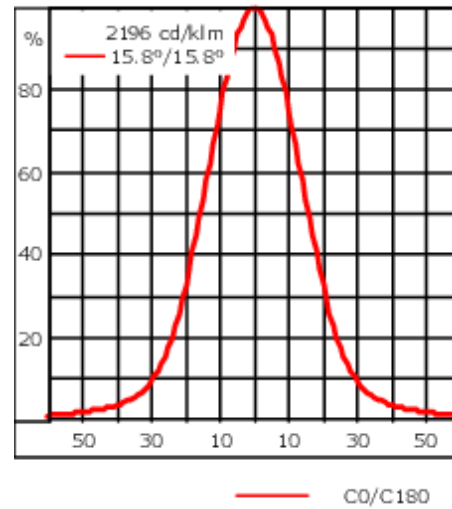
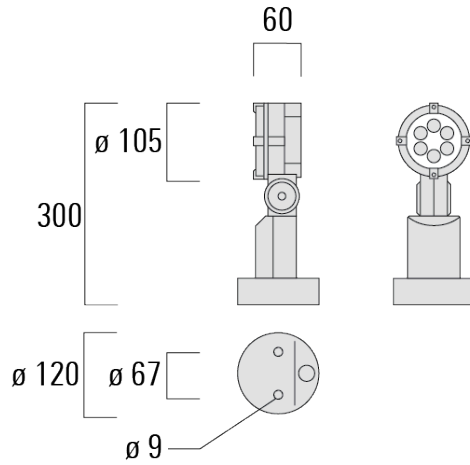

Specifications

Material description

Body	Marine-grade, die-cast aluminium alloy
Lens	Safety glass lens
Colours	<div style="display: flex; align-items: center; gap: 10px;"> <div style="width: 20px; height: 15px; background-color: black; margin-right: 5px;"></div> RAL9004 Signal black <div style="width: 20px; height: 15px; background-color: #808080; margin-right: 5px;"></div> RAL9007 Grey aluminium <div style="width: 20px; height: 15px; background-color: #404040; margin-right: 5px;"></div> RAL7016 Anthracite grey <div style="width: 20px; height: 15px; background-color: #e0e0e0; margin-right: 5px;"></div> RAL9016 Traffic white </div>
Gasket	Silicone CCG® Controlled Compression Gasket
Fasteners	PCS hardware
Ingress protection	IP66
Impact resistance	IK07
Corrosion resistance	5CE
Windage	0.025 m ²

Electrical description

Power supply	220-240V / 50-60 Hz
Driver / Ballast	Integral EC electronic converter in thermally-separated compartment

WE-EF LIGHTING (Thailand) Co., Ltd.

57 Moo 5, Kingkaew Rd., Bangplee, 10540 Samutprakarn - Phone: +66 2 738 96 20 - Fax: +66 2 738 96 29

<https://we-ef.com/asia>

Subject to technical changes and errors. - Generated on 19/04/2025

145-0283

we-ef

FLC121 LED Surface mounted

Additional information

Lifetime	Ta=25° L90B10 > 90000h
----------	------------------------

WE-EF LIGHTING (Thailand) Co., Ltd.

57 Moo 5, Kingkaew Rd., Bangplee, 10540 Samutprakarn - Phone: +66 2 738 96 20 - Fax: +66 2 738 96 29

<https://we-ef.com/asia>

Subject to technical changes and errors. - Generated on 19/04/2025

Optical Accessories

Snoot

Description	Part ID	A	C1
Snoot ET	145-0030	60	120



Linear spread lens

Description	Part ID	C1
Linear spread lens IO-180	145-0050	81



FLC121 LED Surface mounted

Flood lens

Description	Part ID	C1
Flood lens IO-360	145-9390	81

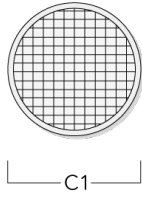

Honeycomb louvre

Description	Part ID	C1
Honeycomb louvre IW	145-0143	81

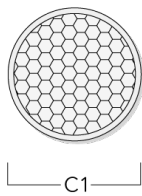

FLC121 LED Surface mounted

Wallwash lens

Description	Part ID	C1
Wallwash lens IO-20	145-0145	81



Glare shield

Description	Part ID	A	C1
Glare shield ES	145-9192	102	119



145-0283

we-ef

FLC121 LED Surface mounted

Linear louvre

Description	Part ID	C1
Linear louvre IL	145-9171	81



Colour correction filter

Description	Part ID
IF-3000K > 2400K	145-9188



WE-EF LIGHTING (Thailand) Co., Ltd.

57 Moo 5, Kingkaew Rd., Bangplee, 10540 Samutprakarn - Phone: +66 2 738 96 20 - Fax: +66 2 738 96 29

<https://we-ef.com/asia>

Subject to technical changes and errors. - Generated on 19/04/2025

Mounting Accessories

Pole clamp

Description	Part ID	D1	Weight (kg)	D
Pole clamp SP1-2/M8, single (Ø 76-89)	146-0246	76-89	1.20	76-89



Pole clamp SP2-2/M8, double (Ø 38-60)	146-0247	38-60	1	38-66
---------------------------------------	----------	-------	---	-------



FLC121 LED Surface mounted

Description	Part ID	D1	Weight (kg)	D
Pole clamp SP2-2/M8, double (Ø 76-89)	146-0248	76-89	1.20	76-89



Pole clamp SP1-2/M8, single (Ø 38-60)	146-0245	38-60	1	38-66
---------------------------------------	----------	-------	---	-------



FLC121 LED Surface mounted

Short post

Description	Part ID	D1	D2	H1	M1	Weight (kg)
Short post EM1-2/M8	146-0253	160	130	200	9	1.10

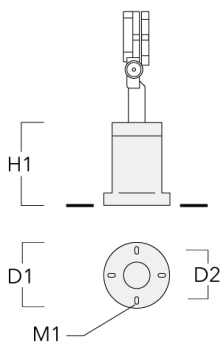

Planted root

Description	Part ID	D1	D2	D3	D4	H1	H2	M1	T1	T2	Weight (kg)
Planted root ESV4	300-0461-AP	150	130	60	89	400	350	8	200	50 x 100	3.85

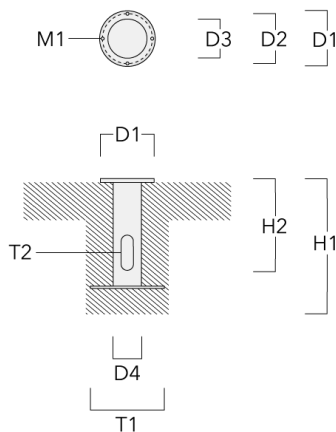

FLC121 LED Surface mounted

Ground spike

Description	Part ID	H1	Weight (kg)
Ground spike EF1 (including cable and plug)	146-0251	270	0.40



Ground spike EF1 (without cable and plug)	146-0250	270	0.40
---	----------	-----	------

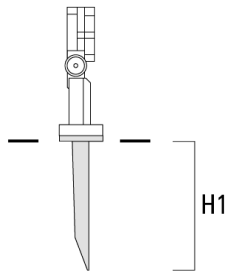

145-0283

we-ef

FLC121 LED Surface mounted

Junction box

Description	Part ID	D1	D2	M1	Weight (kg)
Junction box JB1	310-9000	135	67	9	1.6

