

FLC121 LED



Description

IP66, Class I. Class II on request. IK07. Marine-grade, die-cast aluminium alloy. 5CE superior corrosion protection including PCS hardware. Silicone CCG® Controlled Compression Gasket. Safety glass lens. Integral EC electronic converter in thermally separated compartment. CAD-optimised optics for superior illumination and glare control. OLC® One LED Concept. Factory installed LED circuit board. The luminaire is factory- sealed and does not need to be opened during the installation.

Optional 2200 K version available. To be specified at time of ordering.

| | |
|--------------------|--------------------------------------|
| Weight | 1.70 kg |
| Light distribution | linear spread, very narrow beam [EE] |
| Light source | LED-6/12W / 700 mA - 2700 K |
| CRI | 80 |
| Power supply | EC |
| LEDs | 6 |
| Rated input power | 14.5 W |

Nominal Lumen (lm)

| | |
|----------------|------|
| LED Lumen | 270 |
| Total Lumen | 1620 |
| T _j | 85 |

Rated lumens (lm)

| | |
|----------------|--------|
| LED Lumen | 232.2 |
| Total Lumen | 1393.3 |
| T _a | 25 |

WE-EF LEUCHTEN GmbH

Töpinger Straße 16, 29646 Bispingen, Germany - Phone: +49 5194 909-0
info@we-ef.com - <https://we-ef.com>

Subject to technical changes and errors. - Generated on 23/11/2024

FLC121 LED

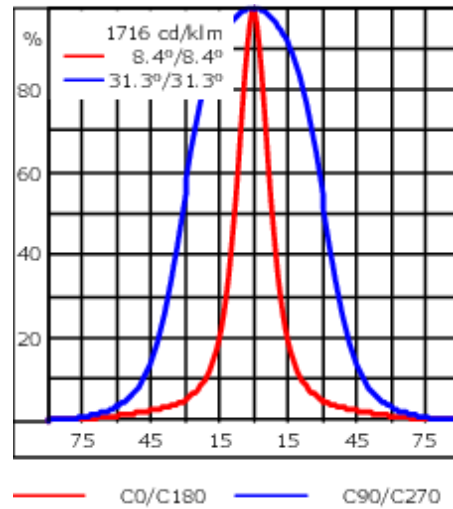
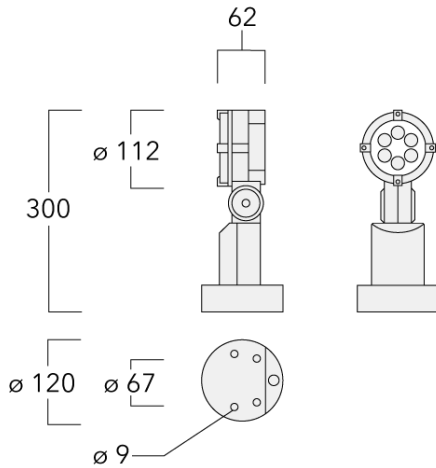

Specifications

Material description

| | |
|----------------------|--|
| Body | Marine-grade, die-cast aluminium alloy |
| Lens | Safety glass lens |
| Colours | <div style="display: flex; align-items: center;"> <div style="width: 20px; height: 20px; background-color: black; margin-right: 5px;"></div> RAL9004 Signal black </div> <div style="display: flex; align-items: center; margin-top: 5px;"> <div style="width: 20px; height: 20px; background-color: #cccccc; margin-right: 5px;"></div> RAL9006 White aluminium </div> <div style="display: flex; align-items: center; margin-top: 5px;"> <div style="width: 20px; height: 20px; background-color: #808080; margin-right: 5px;"></div> RAL9007 Grey aluminium </div> <div style="display: flex; align-items: center; margin-top: 5px;"> <div style="width: 20px; height: 20px; background-color: #444444; margin-right: 5px;"></div> RAL7016 Anthracite grey </div> <div style="display: flex; align-items: center; margin-top: 5px;"> <div style="width: 20px; height: 20px; background-color: #e0e0e0; margin-right: 5px;"></div> RAL9016 Traffic white </div> |
| Gasket | Silicone CCG® Controlled Compression Gasket |
| Fasteners | PCS Polymer Coated Stainless Steel Hardware |
| Ingress protection | IP66 |
| Impact resistance | IK07 |
| Corrosion resistance | 5CE |
| Windage | 0.025 m ² |

FLC121 LED

Electrical description

| | |
|------------------|---|
| Power supply | 220-240V / 50-60 Hz |
| Driver / Ballast | Integral EC electronic converter in thermally-separated compartment |
| Surge protection | 1/2 kV |

Additional information

| | |
|-------------------------|------------------------|
| Lifetime | Ta=25° L90B10 > 90000h |
| Energy efficiency class | C-D (Light source) |

FLC121 LED

Optical Accessories

Snoot

| Description | Part ID | A | C1 |
|-------------|----------|----|-----|
| Snoot ET | 145-0030 | 60 | 120 |

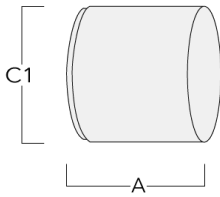

Linear spread lens

| Description | Part ID | C1 |
|-------------------|----------|----|
| IO-180-FLC121-LED | 145-0050 | 81 |

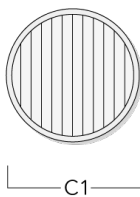

FLC121 LED

Flood lens

| Description | Part ID | C1 |
|-------------------|----------|----|
| IO-360-FLC121-LED | 145-0142 | 81 |

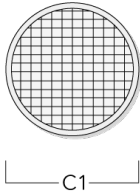

Honeycomb louvre

| Description | Part ID | C1 |
|---------------------------|----------|----|
| IW-FLC121-LED - [EE][EES] | 145-0143 | 81 |

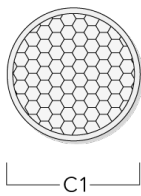

FLC121 LED

Wallwash lens

| Description | Part ID | C1 |
|---------------------|----------|----|
| IO-20-WW-FLC121-LED | 145-0145 | 81 |

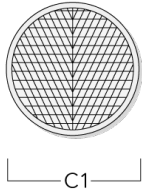

Glare shield

| Description | Part ID | A | C1 |
|-----------------|----------|-----|-----|
| Glare shield ES | 145-9192 | 102 | 119 |

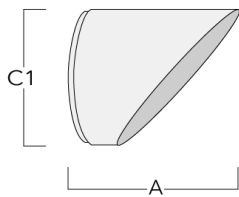

Mounting Accessories

Pipe clamp SP

| Description | Part ID | D1 | Weight (kg) | D |
|---------------------------------------|----------|-------|-------------|-------|
| SP1-2/M8 Pole clamp, single (Ø 76-89) | 146-0246 | 76-89 | 1.20 | 76-89 |

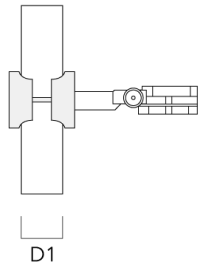

| | | | | |
|---------------------------------------|----------|-------|---|-------|
| SP2-2/M8 Pole clamp, double (Ø 38-60) | 146-0247 | 38-60 | 1 | 38-60 |
|---------------------------------------|----------|-------|---|-------|

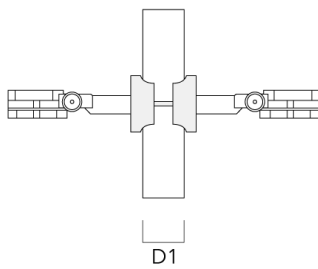

FLC121 LED

| Description | Part ID | D1 | Weight (kg) | D |
|---------------------------------------|----------|-------|-------------|-------|
| SP2-2/M8 Pole clamp, double (Ø 76-89) | 146-0248 | 76-89 | 1.20 | 76-89 |



| | | | | |
|---------------------------------------|----------|-------|---|-------|
| SP1-2/M8 Pole clamp, single (Ø 38-60) | 146-0245 | 38-60 | 1 | 38-66 |
|---------------------------------------|----------|-------|---|-------|

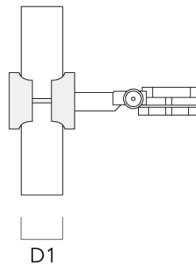

FLC121 LED

Short post EM

| Description | Part ID | D1 | D2 | H1 | M1 | Weight (kg) |
|-------------|----------|-----|-----|-----|----|-------------|
| EM1-2/M8 | 146-0253 | 160 | 130 | 200 | 9 | 1.10 |

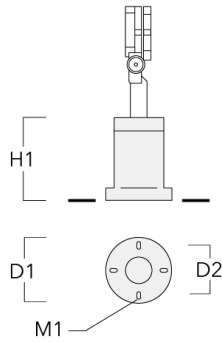

Ground spike EF

| Description | Part ID | H1 | Weight (kg) |
|-----------------------|----------|-----|-------------|
| Ground spike EF1-2/M8 | 146-0251 | 270 | 0.40 |

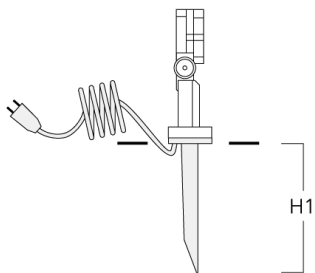

FLC121 LED

Planted root

| Description | Part ID | D1 | D2 | D3 | D4 | H1 | H2 | M1 | Weight(kg) |
|-------------------|----------|-----|-----|-----|-----|-----|-----|----|------------|
| Planted root ESV4 | 300-0461 | 145 | 130 | 102 | 108 | 400 | 350 | 8 | 7.85 |

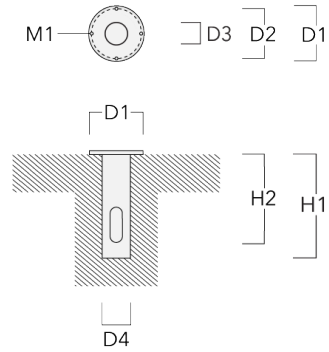

Junction box JB1

| Description | Part ID | D1 | D2 | M1 | Weight(kg) |
|------------------|----------|-----|----|----|------------|
| JB1 Junction box | 310-9000 | 135 | 67 | 9 | 1.6 |

