



**Description**

IP66, Class I. Class II on request. IK07. Marine-grade, die-cast aluminium alloy. 5CE superior corrosion protection including PCS hardware. Silicone CCG® Controlled Compression Gasket. Safety glass lens. Integral EC electronic converter in thermally separated compartment. CAD-optimised optics for superior illumination and glare control. OLC® One LED Concept. Factory installed LED circuit board. The luminaire is factory-sealed and does not need to be opened during the installation.

Optional 2200 K version available. To be specified at time of ordering.

Weight	2.50 kg
Light distribution	symmetric, wide beam [B]
Light source	LED-12/24W / 700 mA - 2700 K
CRI	80
Power supply	EC
LEDs	12
Rated input power	27 W
<b>Nominal Lumen (lm)</b>	
LED Lumen	270
Total Lumen	3240
Tj	85
<b>Rated lumens (lm)</b>	
LED Lumen	210.2
Total Lumen	2522.3
Ta	25

146-0796



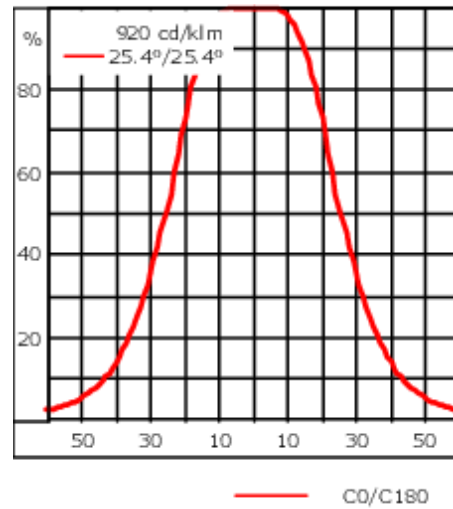
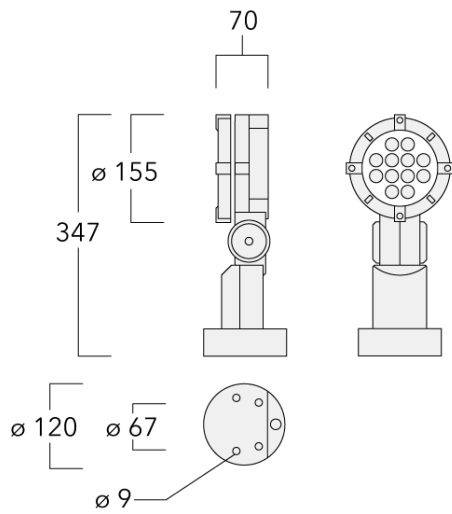

FLC131 LED

we-ef



## Specifications

### Material description

Body	Marine-grade, die-cast aluminium alloy
Lens	Safety glass lens
Colours	 RAL9004 Signal black  RAL9006 White aluminium  RAL9007 Grey aluminium  RAL7016 Anthracite grey  RAL9016 Traffic white
Gasket	Silicone rubber gaskets
Fasteners	PCS Polymer Coated Stainless Steel Hardware
Ingress protection	IP66
Impact resistance	IK07
Corrosion resistance	5CE
Windage	0.041 m <sup>2</sup>

WE-EF LEUCHTEN GmbH

Töpinger Straße 16, 29646 Bispingen, Germany - Phone: +49 5194 909-0

info@we-ef.com - <https://we-ef.com>

Subject to technical changes and errors. - Generated on 23/10/2024

**146-0796**

**FLC131 LED**

**we-ef**

### **Electrical description**

---

Power supply	220-240V / 50-60 Hz
Driver / Ballast	Integral EC electronic converter in thermally-separated compartment
Surge protection	1/2 kV

---

### **Additional information**

---

Lifetime	Ta=25° L90B10 > 90000h
Energy efficiency class	C-D (Light source)

---

**WE-EF LEUCHTEN GmbH**

Töpinger Straße 16, 29646 Bispingen, Germany - Phone: +49 5194 909-0  
info@we-ef.com - <https://we-ef.com>

Subject to technical changes and errors. - Generated on 23/10/2024

146-0796

FLC131 LED

**we-ef**

## Optical Accessories

### Glare shield

Description	Part ID	A	C1
Glare shield ES	146-0156	110	100



### Snoot

Description	Part ID	A	C1
Snoot ET	146-0397	95,5	126



### Flood lens

#### WE-EF LEUCHTEN GmbH

Töpinger Straße 16, 29646 Bispingen, Germany - Phone: +49 5194 909-0

info@we-ef.com - <https://we-ef.com>

Subject to technical changes and errors. - Generated on 23/10/2024

146-0796

FLC131 LED

**we-ef**

---

Description	Part ID	C1
IO-360	146-0623	110

---

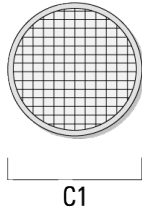

---

### Linear spread lens

---

Description	Part ID	C1
IO-180-FLC131-LED	146-0418	110.00

---

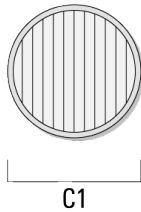

---

### Wallwash lens

**WE-EF LEUCHTEN GmbH**

Töpinger Straße 16, 29646 Bispingen, Germany - Phone: +49 5194 909-0

info@we-ef.com - <https://we-ef.com>

Subject to technical changes and errors. - Generated on 23/10/2024

146-0796

FLC131 LED

**we-ef**

---

Description	Part ID	C1
IO-20-WW-FLC131-LED	146-0645	110

---

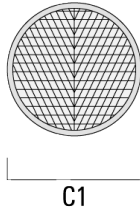

---

### Honeycomb louvre

---

Description	Part ID	C1
IW-FLC131-LED - [EE][EES]	146-0625	110

---

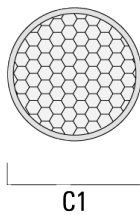

---

#### WE-EF LEUCHTEN GmbH

Töpinger Straße 16, 29646 Bispingen, Germany - Phone: +49 5194 909-0

info@we-ef.com - <https://we-ef.com>

Subject to technical changes and errors. - Generated on 23/10/2024

146-0796

FLC131 LED

**we-ef**

## Mounting Accessories

### Pipe clamp SP

Description	Part ID	D1	Weight (kg)	D
SP1-2/M8 Pole clamp, single (Ø 76-89)	146-0246	76-89	1.20	76-89

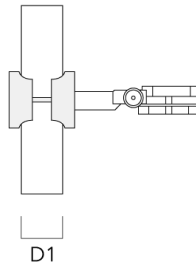

SP2-2/M8 Pole clamp, double (Ø 38-60)	146-0247	38-60	1	38-66
---------------------------------------	----------	-------	---	-------



#### WE-EF LEUCHTEN GmbH

Töpinger Straße 16, 29646 Bispingen, Germany - Phone: +49 5194 909-0

info@we-ef.com - <https://we-ef.com>

Subject to technical changes and errors. - Generated on 23/10/2024

146-0796

FLC131 LED

**we-ef**

---

Description	Part ID	D1	Weight (kg)	D
SP2-2/M8 Pole clamp, double (Ø 76-89)	146-0248	76-89	1.20	76-89

---



---

SP1-2/M8 Pole clamp, single (Ø 38-60)	146-0245	38-60	1	38-66
---------------------------------------	----------	-------	---	-------

---



---

## Short post EM

### WE-EF LEUCHTEN GmbH

Töpinger Straße 16, 29646 Bispingen, Germany - Phone: +49 5194 909-0

info@we-ef.com - <https://we-ef.com>

Subject to technical changes and errors. - Generated on 23/10/2024



146-0796

FLC131 LED

**we-ef**

Description	Part ID	D1	D2	H1	M1	Weight (kg)
EM1-2/M8	146-0253	160	130	200	9	1.10

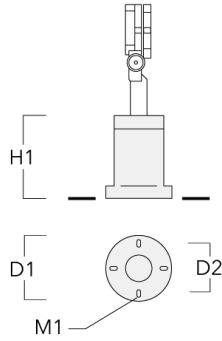

### Ground spike EF

Description	Part ID	H1	Weight (kg)
Ground spike EF1-2/M8	146-0251	270	0.40

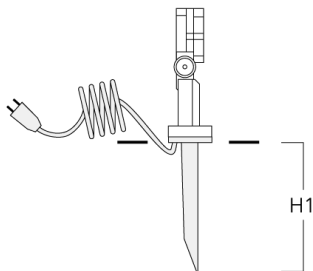

### Planted root

#### WE-EF LEUCHTEN GmbH

Töpinger Straße 16, 29646 Bispingen, Germany - Phone: +49 5194 909-0

info@we-ef.com - <https://we-ef.com>

Subject to technical changes and errors. - Generated on 23/10/2024

Description	Part ID	D1	D2	D3	D4	H1	H2	M1	Weight (kg)
Planted root ESV4	300-0461	145	130	102	108	400	350	8	7.85

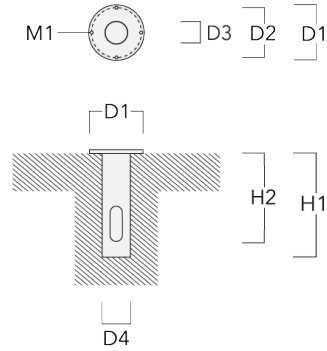

**Junction box JB1**

Description	Part ID	D1	D2	M1	Weight (kg)
JB1 Junction box	310-9000	135	67	9	1.6

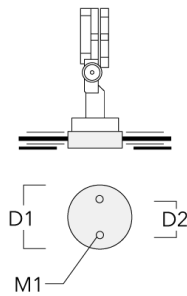

**146-0796**

**FLC131 LED**

**WE-EF LEUCHTEN GmbH**

Töpinger Straße 16, 29646 Bispingen, Germany

Phone: +49 5194 909-0

[info@we-ef.com](mailto:info@we-ef.com)

<https://we-ef.com>

Subject to technical changes and errors.

Generated on 23/10/2024