

146-0872

FLC141 LED

**we-ef**



### Description

IP66, Class I. Class II on request. IK07. Marine-grade, die-cast aluminium alloy. 5CE superior corrosion protection including PCS hardware. Silicone CCG® Controlled Compression Gasket. Safety glass lens. Integral EC electronic converter in thermally separated compartment. CAD-optimised optics for superior illumination and glare control. OLC® One LED Concept. Factory installed LED circuit board. The luminaire is factory- sealed and does not need to be opened during the installation.

Optional 2200 K version available. To be specified at time of ordering.

Weight	4.40 kg
Light distribution	symmetric, very narrow beam, sharp cut-off [EES]
Light source	LED-24/48W / 700 mA - 2700 K
CRI	80
Power supply	EC
LEDs	24
Rated input power	54 W

### Nominal Lumen (lm)

LED Lumen	270
Total Lumen	6480
Tj	85

### Rated lumens (lm)

LED Lumen	249.9
Total Lumen	5998.4
Ta	25

### Fagerhult Lighting Ltd

33-34 Dolben Street, SE1 0UQ London, United Kingdom

<https://we-ef.com/uk>

Subject to technical changes and errors. - Generated on 23/11/2024

146-0872



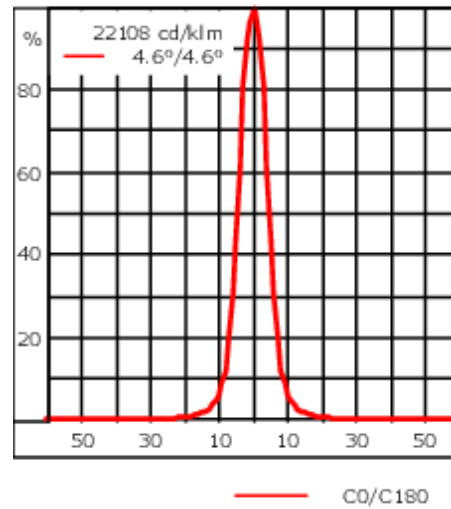
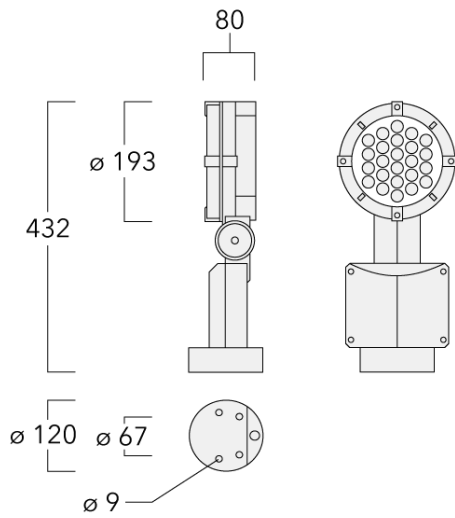

FLC141 LED

we-ef



## Specifications

### Material description

Body	Marine-grade, die-cast aluminium alloy
Lens	Safety glass lens
Colours	 RAL9004 Signal black  RAL9006 White aluminium  RAL9007 Grey aluminium  RAL7016 Anthracite grey  RAL9016 Traffic white
Gasket	Silicone CCG® Controlled Compression Gasket
Fasteners	PCS Polymer Coated Stainless Steel Hardware
Ingress protection	IP66
Impact resistance	IK07
Corrosion resistance	5CE
Windage	0.057 m <sup>2</sup>

Fagerhult Lighting Ltd

33-34 Dolben Street, SE1 0UQ London, United Kingdom

<https://we-ef.com/uk>

Subject to technical changes and errors. - Generated on 23/11/2024

**146-0872**

**FLC141 LED**

**we-ef**

### **Electrical description**

---

Power supply	220-240V / 50-60 Hz
Driver / Ballast	Integral EC electronic converter in thermally-separated compartment
Surge protection	1/2 kV

---

### **Additional information**

---

Lifetime	Ta=25° L90B10 > 90000h
Energy efficiency class	C-D (Light source)

---

146-0872

FLC141 LED

**we-ef**

## Optical Accessories

### Glare shield

Description	Part ID	A	C1
Glare shield ES	146-0229	120	145



### Snoot

Description	Part ID	A	C1
Snoot ET	146-0398	120	145

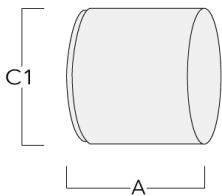

146-0872

FLC141 LED

**we-ef**

**Honeycomb louvre**

---

Description	Part ID	C1
IW-FLC141-LED - [EE][EES]	146-0626	145

---

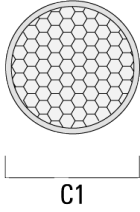

146-0872

FLC141 LED

**we-ef**

## Mounting Accessories

### Pipe clamp SP

Description	Part ID	D1	Weight (kg)	D
SP1-2/M8 Pole clamp, single (Ø 76-89)	146-0246	76-89	1.20	76-89

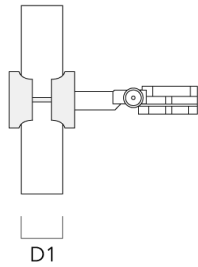

SP2-2/M8 Pole clamp, double (Ø 38-60)	146-0247	38-60	1	38-66
---------------------------------------	----------	-------	---	-------

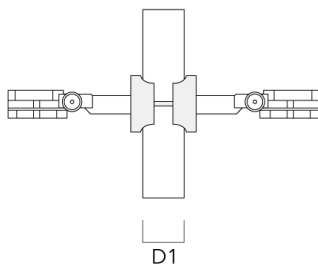

#### Fagerhult Lighting Ltd

33-34 Dolben Street, SE1 0UQ London, United Kingdom

<https://we-ef.com/uk>

Subject to technical changes and errors. - Generated on 23/11/2024

146-0872

FLC141 LED

**we-ef**

---

Description	Part ID	D1	Weight (kg)	D
SP2-2/M8 Pole clamp, double (Ø 76-89)	146-0248	76-89	1.20	76-89

---

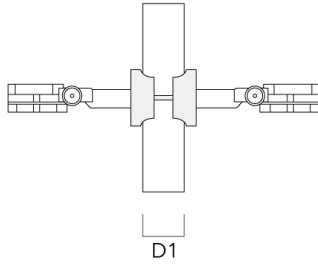

---

SP1-2/M8 Pole clamp, single (Ø 38-60)	146-0245	38-60	1	38-66
---------------------------------------	----------	-------	---	-------

---

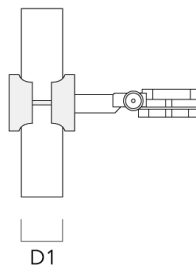

**Fagerhult Lighting Ltd**

33-34 Dolben Street, SE1 0UQ London, United Kingdom

<https://we-ef.com/uk>

Subject to technical changes and errors. - Generated on 23/11/2024

146-0872

FLC141 LED

**we-ef**

**Short post EM**

Description	Part ID	D1	D2	H1	M1	Weight (kg)
EM1-2/M8	146-0253	160	130	200	9	1.10

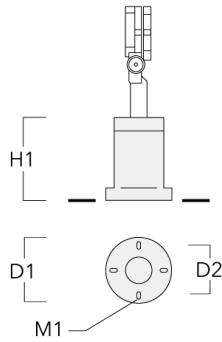

**Ground spike EF**

Description	Part ID	H1	Weight (kg)
Ground spike EF1-2/M8	146-0251	270	0.40

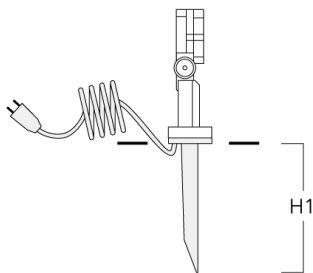

**Fagerhult Lighting Ltd**

33-34 Dolben Street, SE1 0UQ London, United Kingdom

<https://we-ef.com/uk>

Subject to technical changes and errors. - Generated on 23/11/2024



146-0872

FLC141 LED

**we-ef**

**Planted root**

Description	Part ID	D1	D2	D3	D4	H1	H2	M1	Weight(kg)
Planted root ESV4	300-0461	145	130	102	108	400	350	8	7.85

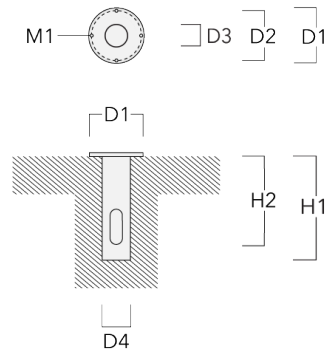

**Junction box JB1**

Description	Part ID	D1	D2	M1	Weight(kg)
JB1 Junction box	310-9000	135	67	9	1.6

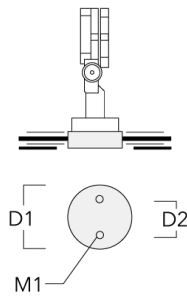

**Fagerhult Lighting Ltd**

33-34 Dolben Street, SE1 0UQ London, United Kingdom

<https://we-ef.com/uk>

Subject to technical changes and errors. - Generated on 23/11/2024