

146-0872

FLC141 LED POST

we-ef



Description

IP66. Class I. IK07. Marine-grade, die-cast aluminum alloy. 5CE superior corrosion protection including PCS hardware. Silicone CCG® Controlled Compression Gasket. Safety glass lens. CAD-optimized optics for superior illumination and glare control. OLC® One LED Concept. Factory-installed LED circuit board. 0-10V Dimming comes standard with luminaire. Luminaire is factory-sealed and does not need to be opened during installation.

Knuckle permits 350° horizontal and 90° vertical aiming of optics.

Specify product with 7 Digit product code - Finish Color. Accessories, such as mounting, optical, and electrical, must be specified separately.

Example: XXX-XXXX-9004 (Black).
+ XXX-XXXX (Accessory 1)

Weight	9.70 lb
Light distribution	symmetric, very narrow beam, 'sharp cut-off' [VNS]
Light source	LED-24/48W / 700 mA - 2700 K
CRI	80
Power supply	electronic gear
LEDs	24
Rated input power	54 W
Nominal Lumen (lm)	
LED Lumen	270
Total Lumen	6480
Tj	85
Rated lumens (lm)	
LED Lumen	249.9
Total Lumen	5998.4
Ta	25

WE-EF LIGHTING USA, LLC

410-D Keystone Drive, 15086 Warrendale, PA 15086 - Phone: +1 724 742 0030
customersupport.usa@we-ef.com - <https://we-ef.com/us>
Subject to technical changes and errors. - Generated on 11/23/2024

146-0872

we-ef

FLC141 LED POST

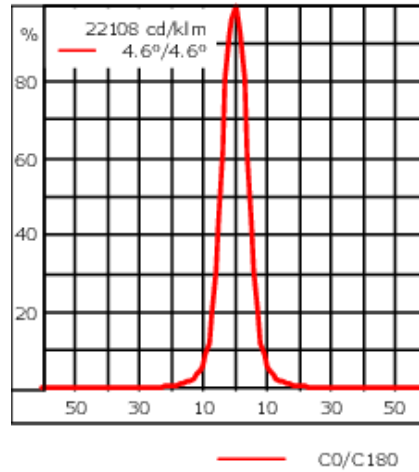
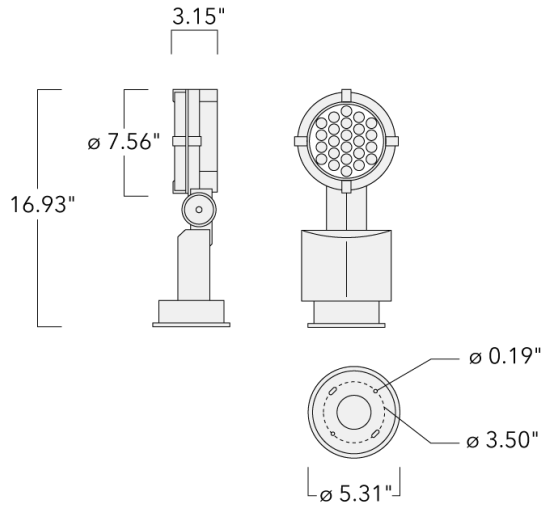

Specifications

Material description

Body	Marine-grade, die-cast aluminium alloy
Lens	Safety glass lens
Colors	<div style="display: flex; flex-direction: column; gap: 5px;"> <div> RAL9004 Black</div> <div> RAL9007 Grey Metallic</div> <div> RAL9016 White</div> <div> RAL8019 Dark Bronze</div> </div>
Gasket	Silicone rubber gasket
Fasteners	PCS polymer coated stainless steel
Ingress protection	IP66
Impact resistance	IK07
Corrosion resistance	5CE
Windage	0.057 m ²

Electrical description

Power supply	Integral [ECG] electronic driver 120V-277V. 0-10V dimmable, to be specified with order.
Driver / Ballast	Integral EC electronic converter in thermally-separated compartment
Surge protection	Integral 10kV Surge Protector

WE-EF LIGHTING USA, LLC

410-D Keystone Drive, 15086 Warrendale, PA 15086 - Phone: +1 724 742 0030

customersupport.usa@we-ef.com - <https://we-ef.com/us>

Subject to technical changes and errors. - Generated on 11/23/2024

146-0872

we-ef

FLC141 LED POST

Additional information

Lifetime Ta=25°/40° L90B10 > 90000h

Listings ETL, UL-1598, CSA-C22.2#250.0. Suitable for Wet Locations.

WE-EF LIGHTING USA, LLC

410-D Keystone Drive, 15086 Warrendale, PA 15086 - Phone: +1 724 742 0030

customersupport.usa@we-ef.com - <https://we-ef.com/us>

Subject to technical changes and errors. - Generated on 11/23/2024

146-0872

we-ef

FLC141 LED POST

Optical Accessories

Glare shield

Description	Part ID	A	C1
Glare shield ES	146-0229	4.72	5.71

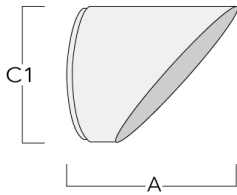

WE-EF LIGHTING USA, LLC

410-D Keystone Drive, 15086 Warrendale, PA 15086 - Phone: +1 724 742 0030
customersupport.usa@we-ef.com - <https://we-ef.com/us>

Subject to technical changes and errors. - Generated on 11/23/2024

146-0872

we-ef

FLC141 LED POST

Snoot

Description	Part ID	A	C1
Snoot ET	146-0398	4.72	5.70

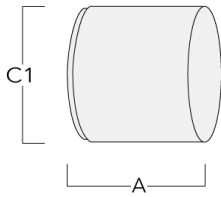

Honeycomb louvre

Description	Part ID	C1
IW-FLC141-LED	146-0626	5.70

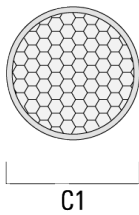

WE-EF LIGHTING USA, LLC

410-D Keystone Drive, 15086 Warrendale, PA 15086 - Phone: +1 724 742 0030
customersupport.usa@we-ef.com - <https://we-ef.com/us>
Subject to technical changes and errors. - Generated on 11/23/2024

146-0872

we-ef

FLC141 LED POST

Mounting Accessories

Pipe clamp SP

Description	Part ID	D1	M1	Weight (lb)	D
SP1-2/M8 Pipe clamp, single (Ø 3"-3.5")	146-0246	3-3.5		1.20	76-89

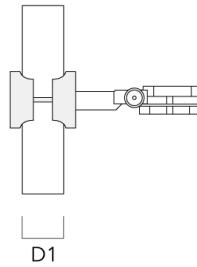

SP2-2/M8 Pipe clamp, double (Ø 1.5"-2.36")	146-0247	1.50"-2.36"	.35	2.20 lbs	38-66
--	----------	-------------	-----	----------	-------

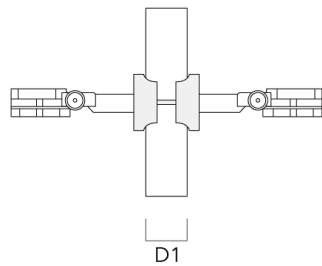

WE-EF LIGHTING USA, LLC

410-D Keystone Drive, 15086 Warrendale, PA 15086 - Phone: +1 724 742 0030
customersupport.usa@we-ef.com - <https://we-ef.com/us>
Subject to technical changes and errors. - Generated on 11/23/2024

146-0872

we-ef

FLC141 LED POST

Description	Part ID	D1	M1	Weight (lb)	D
SP2-2/M8 Pipe clamp, double (Ø 3"-3.5")	146-0248	3.0"-3.5"		2.65 lbs	76-89

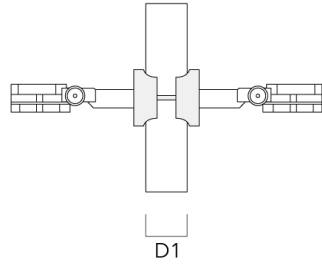

SP1-2/M8 Pipe clamp, single (Ø 1.5"-2.36")	146-0245	38-60	1	38-66
--	----------	-------	---	-------

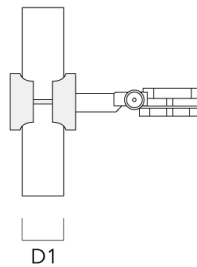

WE-EF LIGHTING USA, LLC

410-D Keystone Drive, 15086 Warrendale, PA 15086 - Phone: +1 724 742 0030
customersupport.usa@we-ef.com - <https://we-ef.com/us>
Subject to technical changes and errors. - Generated on 11/23/2024

FLC141 LED POST

Short post EM

Description	Part ID	D1	D2	H1	M1	Weight (lb)
EM1-2/M8	146-0253	6.3	5.12	7.87	0.35	3.00

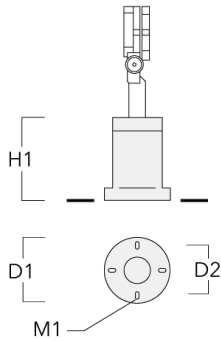

Planted root

Description	Part ID	D1	D2	D3	D4	H1	H2	M1	Weight (lb)
Planted root ESV4	300-0461	5.71	5.12	4.01	4.25	15.75	13.78	.31	15.50

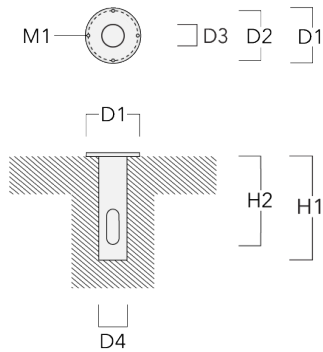

WE-EF LIGHTING USA, LLC

410-D Keystone Drive, 15086 Warrendale, PA 15086 - Phone: +1 724 742 0030

customersupport.usa@we-ef.com - <https://we-ef.com/us>

Subject to technical changes and errors. - Generated on 11/23/2024

FLC141 LED POST

Junction box JB1

Description	Part ID	D1	D2	M1	Weight (lb)
JB1 Junction box	310-9000	5.31	2.64	0.35	3.53

