



Beschreibung

IP66, SKI. SKII auf Anfrage. IK07. Korrosionsbeständiger Aluminiumguss. PCS beschichtete Edelstahlschrauben. 5CE Korrosionsschutz. CCG® Controlled Compression Gasket Silikondichtung. Sicherheitsglas. Eingebaute elektronische Betriebsgeräte, thermisch getrennt. CAD-optimierte OLC® One LED Concept Technik zur Lichtlenkung und Entblendung. Eingebaute LED Platine.

Mit 0,4 m flexibler Anschlussleitung einschließlich Steckverbindung und Befestigungsklammer für RAIL66 Schienensystem.

Gewicht	2.50 kg
Lichtverteilung	wallwash [A20]
Lichtquelle	LED-6/12W / 700 mA - 2700 K
CRI	80
Netz	EVG
LEDs	6
Bemessungsleistung	14.5 W

Nominal Lichtstrom (lm)

LED Lumen	270
Total Lumen	1620
Tj	85

Bemessungslichtstrom (lm)

LED Lumen	188.2
Total Lumen	1129.3
Ta	25



Spezifikationen

Materialbeschreibung

Gehäuse	Korrosionsbeständiger Aluminiumguss
Abdeckung	Sicherheitsglasscheibe
Farben	<div style="display: flex; align-items: center;"> <div style="width: 20px; height: 15px; background-color: black; margin-right: 5px;"></div> <div style="margin-right: 10px;">RAL9004 Signalschwarz</div> </div> <div style="display: flex; align-items: center;"> <div style="width: 20px; height: 15px; background-color: #cccccc; margin-right: 5px;"></div> <div style="margin-right: 10px;">RAL9006 Weißaluminium</div> </div> <div style="display: flex; align-items: center;"> <div style="width: 20px; height: 15px; background-color: #808080; margin-right: 5px;"></div> <div style="margin-right: 10px;">RAL9007 Graualuminium</div> </div> <div style="display: flex; align-items: center;"> <div style="width: 20px; height: 15px; background-color: #333333; margin-right: 5px;"></div> <div style="margin-right: 10px;">RAL7016 Anthrazitgrau</div> </div> <div style="display: flex; align-items: center;"> <div style="width: 20px; height: 15px; background-color: #e0e0e0; margin-right: 5px;"></div> <div style="margin-right: 10px;">RAL9016 Verkehrsweiß</div> </div>
Dichtung	Silikondichtung
Schrauben	PCS beschichtete Edelstahlschrauben
Schutzart	IP66
Schlagfestigkeit	IK07
Korrosionsbeständigkeit	5CE

Elektrische Beschreibung

Netz	220-240V / 50-60 Hz
Netzgerät / Vorschaltgerät	Eingebaute elektronische Betriebsgeräte, thermisch getrennt
Überspannungsschutz	1/2 kV

WE-EF LEUCHTEN GmbH

Töpinger Straße 16, 29646 Bispingen, Germany - Tel: +49 5194 909-0

info.germany@we-ef.com - <https://we-ef.com/de>

Technische Änderungen und Irrtümer vorbehalten. - Erstellt am 19.04.2025

145-0298+145-0145

FLC121 LED RAIL66

we-ef

Weitere Informationen

Lebensdauer Ta=25° L90B10 > 90000h

Energieeffizienzklasse C-D (Lichtquelle)

WE-EF LEUCHTEN GmbH

Töpinger Straße 16, 29646 Bispingen, Germany - Tel: +49 5194 909-0

info.germany@we-ef.com - <https://we-ef.com/de>

Technische Änderungen und Irrtümer vorbehalten. - Erstellt am 19.04.2025

Optisches Zubehör**Abblendtubus**

Beschreibung	Artikelnummer	A	C1
Abblendtubus ET	145-0030	60	120

**Streulinse bandförmig**

Beschreibung	Artikelnummer	C1
IO-180-FLC121-LED	145-0050	81



FLC121 LED RAIL66

Streulinse allseitig

Beschreibung	Artikelnummer	C1
IO-360-FLC121-LED	145-0142	81

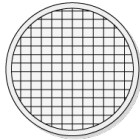

C1

Wabenblende

Beschreibung	Artikelnummer	C1
IW-FLC121-LED - [EE][EES]	145-0143	81

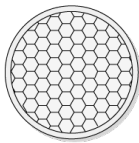

C1

FLC121 LED RAIL66

Wallwash Linse

Beschreibung	Artikelnummer	C1
IO-20-WW-FLC121-LED	145-0145	81



Seitenblende

Beschreibung	Artikelnummer	A	C1
Seitenblende ES	145-9192	102	119

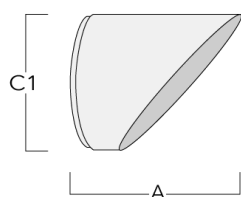

Montagezubehör

Universal

Beschreibung	Artikelnummer	C1	C2	H1	M1	Gewicht (kg)	L1	L2
für 2 Strahler oder Fluter (L=1150)	310-9200	75	30	200	12	5.90	1150	1045

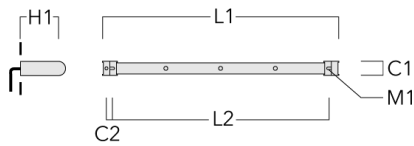

für 3 Strahler oder Fluter (L=1150)	310-9202	75	30	200	12	5.90	1150	1045
-------------------------------------	----------	----	----	-----	----	------	------	------

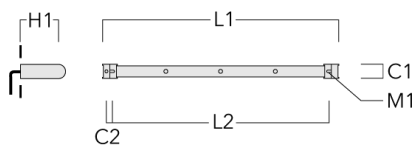

FLC121 LED RAIL66

Beschreibung	Artikelnummer	C1	C2	H1	M1	Gewicht (kg)	L1	L2
für 3 Strahler oder Fluter (L=1650)	310-9210	75	30	200	12	7.20	1650	1545



für 4 Strahler oder Fluter (L=1650)	310-9212	75	30	200	12	7.20	1650	1545
-------------------------------------	----------	----	----	-----	----	------	------	------



FLC121 LED RAIL66

Beschreibung	Artikelnummer	C1	C2	H1	M1	Gewicht (kg)	L1	L2
für 4 Strahler oder Fluter (L=2150)	310-9220	75	30	200	12	8.50	2150	2045

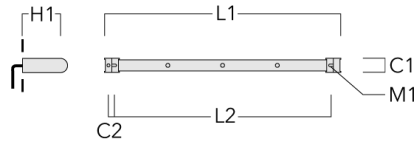

für 6 Strahler oder Fluter (L=2150)	310-9222	75	30	200	12	8.50	2150	2045
-------------------------------------	----------	----	----	-----	----	------	------	------



FLC121 LED RAIL66

Abdeckkappen

Beschreibung	Artikelnummer	C1	C2	D1	D2	L	M1	Gewicht (kg)
Abdeckkappen (Paar)	310-9290	20	30	180	140	1070	9	1.70

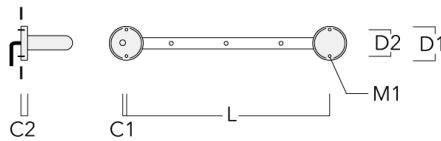

Anschlussadapter

Beschreibung	Artikelnummer	C1	C2	L	M1	Gewicht (kg)
Anschlussadapter (Paar)	310-9294	30	100	1115	12	0.90



FLC121 LED RAIL66

Ausleger

Beschreibung	Artikelnummer	C1	C2	C3	H1	M1	Gewicht (kg)	L1	L2
für 2 Strahler oder Fluter (L=1150)	310-9230	220	120	60	600	13	12	1150	1070

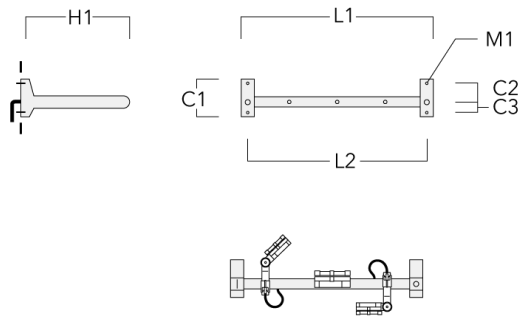

für 3 Strahler oder Fluter (L=1150)	310-9232	220	120	60	600	13	12	1150	1070
-------------------------------------	----------	-----	-----	----	-----	----	----	------	------

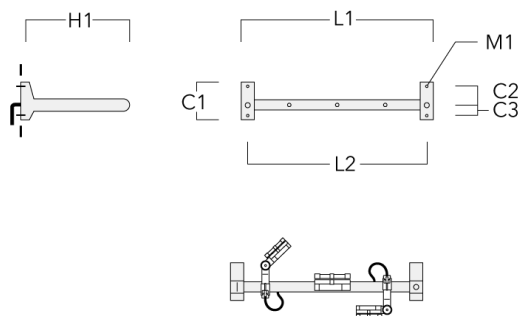

FLC121 LED RAIL66

Beschreibung	Artikelnummer	C1	C2	C3	H1	M1	Gewicht (kg)	L1	L2
für 3 Strahler oder Fluter (L=1650)	310-9240	220	120	60	600	13	13.30	1650	1570

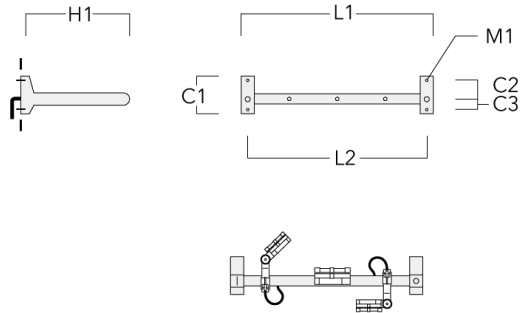

für 4 Strahler oder Fluter (L=1650)	310-9242	220	120	60	600	13	13.30	1650	1570
-------------------------------------	----------	-----	-----	----	-----	----	-------	------	------

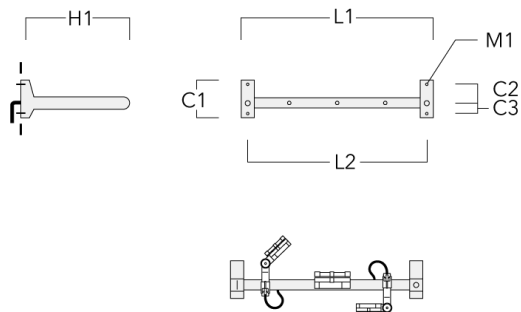

FLC121 LED RAIL66

Beschreibung	Artikelnummer	C1	C2	C3	H1	M1	Gewicht (kg)	L1	L2
für 4 Strahler oder Fluter (L=2150)	310-9250	220	120	60	600	13	14.60	2150	2070

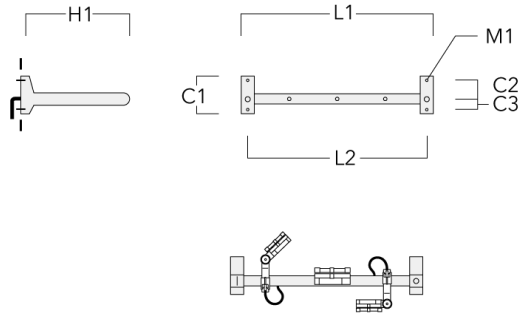

für 6 Strahler oder Fluter (L=2150)	310-9252	220	120	60	600	13	14.60	2150	2070
-------------------------------------	----------	-----	-----	----	-----	----	-------	------	------

