



Beschreibung

IP66, SKI. SKII auf Anfrage. IK07. Korrosionsbeständiger Aluminiumguss. PCS beschichtete Edelstahlschrauben. 5CE Korrosionsschutz. CCG® Controlled Compression Gasket Silikondichtung. Sicherheitsglas. Eingebaute elektronische Betriebsgeräte, thermisch getrennt. CAD-optimierte OLC® One LED Concept Technik zur Lichtlenkung und Entblendung. Eingebaute LED Platine.

Mit 0,4 m flexibler Anschlussleitung einschließlich Steckverbindung und Befestigungsklammer für RAIL66 Schienensystem.

| | |
|--------------------|-------------------------------------|
| Gewicht | 2.50 kg |
| Lichtverteilung | bandförmig extrem engstrahlend [EE] |
| Lichtquelle | LED-6/12W / 700 mA - 2700 K |
| CRI | 80 |
| Netz | EVG |
| LEDs | 6 |
| Bemessungsleistung | 14.5 W |

Nominal Lichtstrom (lm)

| | |
|-------------|------|
| LED Lumen | 270 |
| Total Lumen | 1620 |
| Tj | 85 |

Bemessungslichtstrom (lm)

| | |
|-------------|--------|
| LED Lumen | 215.1 |
| Total Lumen | 1290.7 |
| Ta | 25 |

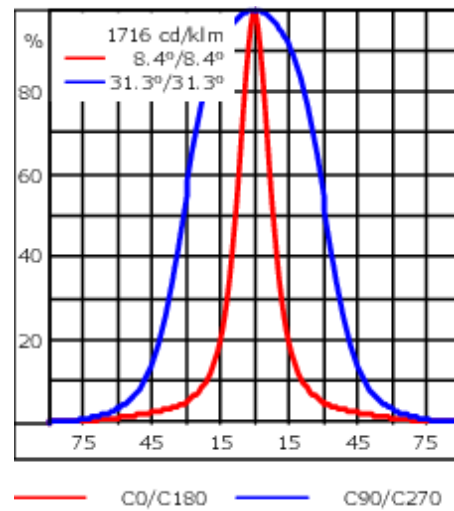

Spezifikationen

Materialbeschreibung

| | |
|-------------------------|---|
| Gehäuse | Korrosionsbeständiger Aluminiumguss |
| Abdeckung | Sicherheitsglasscheibe |
| Farben | <div style="display: flex; align-items: center;"> <div style="width: 20px; height: 15px; background-color: black; margin-right: 5px;"></div> RAL9004 Signalschwarz </div> <div style="display: flex; align-items: center; margin-top: 5px;"> <div style="width: 20px; height: 15px; background-color: #cccccc; margin-right: 5px;"></div> RAL9006 Weißaluminium </div> <div style="display: flex; align-items: center; margin-top: 5px;"> <div style="width: 20px; height: 15px; background-color: #808080; margin-right: 5px;"></div> RAL9007 Graualuminium </div> <div style="display: flex; align-items: center; margin-top: 5px;"> <div style="width: 20px; height: 15px; background-color: #333333; margin-right: 5px;"></div> RAL7016 Anthrazitgrau </div> <div style="display: flex; align-items: center; margin-top: 5px;"> <div style="width: 20px; height: 15px; background-color: #e0e0e0; margin-right: 5px;"></div> RAL9016 Verkehrsweiß </div> |
| Dichtung | Silikondichtung |
| Schrauben | PCS beschichtete Edelstahlschrauben |
| Schutzart | IP66 |
| Schlagfestigkeit | IK07 |
| Korrosionsbeständigkeit | 5CE |

Elektrische Beschreibung

| | |
|-------------------------------|---|
| Netz | 220-240V / 50-60 Hz |
| Netzgerät / Vorschaltgerät | Eingebaute elektronische Betriebsgeräte, thermisch getrennt |
| Überspannungsschutz | 1/2 kV |

WE-EF LEUCHTEN GmbH

Töpinger Straße 16, 29646 Bispingen, Germany - Tel: +49 5194 909-0

info.germany@we-ef.com - <https://we-ef.com/de>

Technische Änderungen und Irrtümer vorbehalten. - Erstellt am 23.11.2024

145-0299+145-0050

FLC121 LED RAIL66

we-ef

Weitere Informationen

Lebensdauer Ta=25° L90B10 > 90000h

Energieeffizienzklasse C-D (Lichtquelle)

WE-EF LEUCHTEN GmbH

Töpinger Straße 16, 29646 Bispingen, Germany - Tel: +49 5194 909-0

info.germany@we-ef.com - <https://we-ef.com/de>

Technische Änderungen und Irrtümer vorbehalten. - Erstellt am 23.11.2024

FLC121 LED RAIL66

Optisches Zubehör

Abblendtubus

| Beschreibung | Artikelnummer | A | C1 |
|-----------------|---------------|----|-----|
| Abblendtubus ET | 145-0030 | 60 | 120 |

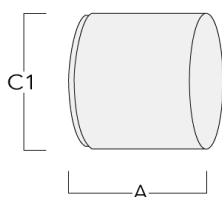

Streulinse bandförmig

| Beschreibung | Artikelnummer | C1 |
|-------------------|---------------|----|
| IO-180-FLC121-LED | 145-0050 | 81 |

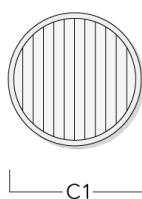

FLC121 LED RAIL66

Streulinse allseitig

| Beschreibung | Artikelnummer | C1 |
|-------------------|---------------|----|
| IO-360-FLC121-LED | 145-0142 | 81 |

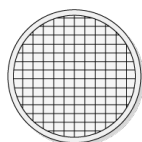

Wabenblende

| Beschreibung | Artikelnummer | C1 |
|---------------------------|---------------|----|
| IW-FLC121-LED - [EE][EES] | 145-0143 | 81 |

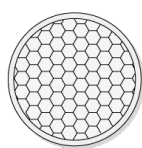

FLC121 LED RAIL66

Wallwash Linse

| Beschreibung | Artikelnummer | C1 |
|---------------------|---------------|----|
| IO-20-WW-FLC121-LED | 145-0145 | 81 |

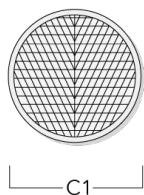

Seitenblende

| Beschreibung | Artikelnummer | A | C1 |
|-----------------|---------------|-----|-----|
| Seitenblende ES | 145-9192 | 102 | 119 |

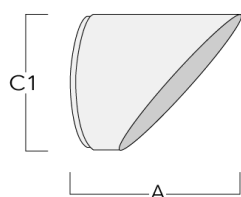

FLC121 LED RAIL66

Montagezubehör

Universal

| Beschreibung | Artikelnummer | C1 | C2 | H1 | M1 | Gewicht (kg) | L1 | L2 |
|-------------------------------------|---------------|----|----|-----|----|--------------|------|------|
| für 2 Strahler oder Fluter (L=1150) | 310-9200 | 75 | 30 | 200 | 12 | 5.90 | 1150 | 1045 |

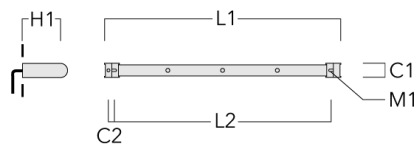

| | | | | | | | | |
|-------------------------------------|----------|----|----|-----|----|------|------|------|
| für 3 Strahler oder Fluter (L=1150) | 310-9202 | 75 | 30 | 200 | 12 | 5.90 | 1150 | 1045 |
|-------------------------------------|----------|----|----|-----|----|------|------|------|

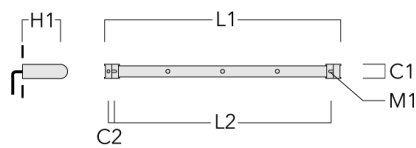

FLC121 LED RAIL66

| Beschreibung | Artikelnummer | C1 | C2 | H1 | M1 | Gewicht (kg) | L1 | L2 |
|-------------------------------------|---------------|----|----|-----|----|--------------|------|------|
| für 3 Strahler oder Fluter (L=1650) | 310-9210 | 75 | 30 | 200 | 12 | 7.20 | 1650 | 1545 |



| | | | | | | | | |
|-------------------------------------|----------|----|----|-----|----|------|------|------|
| für 4 Strahler oder Fluter (L=1650) | 310-9212 | 75 | 30 | 200 | 12 | 7.20 | 1650 | 1545 |
|-------------------------------------|----------|----|----|-----|----|------|------|------|



FLC121 LED RAIL66

| Beschreibung | Artikelnummer | C1 | C2 | H1 | M1 | Gewicht (kg) | L1 | L2 |
|-------------------------------------|---------------|----|----|-----|----|--------------|------|------|
| für 4 Strahler oder Fluter (L=2150) | 310-9220 | 75 | 30 | 200 | 12 | 8.50 | 2150 | 2045 |

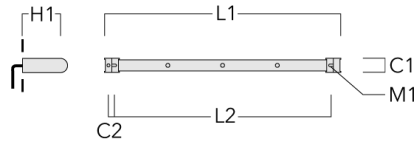

| | | | | | | | | |
|-------------------------------------|----------|----|----|-----|----|------|------|------|
| für 6 Strahler oder Fluter (L=2150) | 310-9222 | 75 | 30 | 200 | 12 | 8.50 | 2150 | 2045 |
|-------------------------------------|----------|----|----|-----|----|------|------|------|

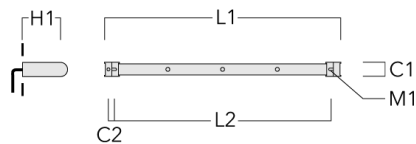

FLC121 LED RAIL66

Abdeckkappen

| Beschreibung | Artikelnummer | C1 | C2 | D1 | D2 | L | M1 | Gewicht (kg) |
|---------------------|---------------|----|----|-----|-----|------|----|--------------|
| Abdeckkappen (Paar) | 310-9290 | 20 | 30 | 180 | 140 | 1070 | 9 | 1.70 |

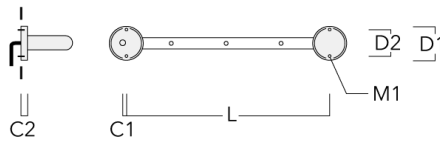

Anschlussadapter

| Beschreibung | Artikelnummer | C1 | C2 | L | M1 | Gewicht (kg) |
|-------------------------|---------------|----|-----|------|----|--------------|
| Anschlussadapter (Paar) | 310-9294 | 30 | 100 | 1115 | 12 | 0.90 |

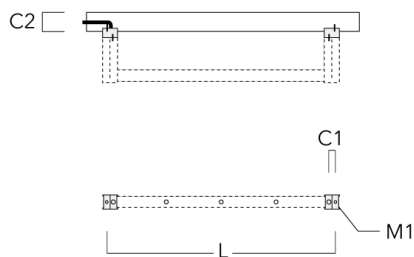

FLC121 LED RAIL66

Ausleger

| Beschreibung | Artikelnummer | C1 | C2 | C3 | H1 | M1 | Gewicht (kg) | L1 | L2 |
|-------------------------------------|---------------|-----|-----|----|-----|----|--------------|------|------|
| für 2 Strahler oder Fluter (L=1150) | 310-9230 | 220 | 120 | 60 | 600 | 13 | 12 | 1150 | 1070 |

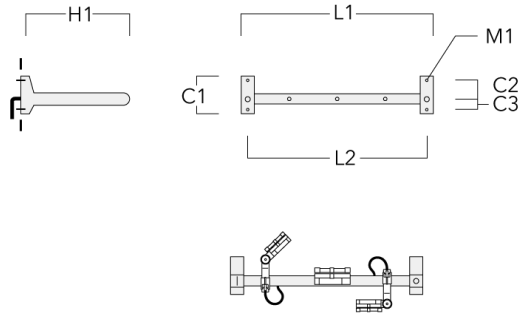

| | | | | | | | | | |
|-------------------------------------|----------|-----|-----|----|-----|----|----|------|------|
| für 3 Strahler oder Fluter (L=1150) | 310-9232 | 220 | 120 | 60 | 600 | 13 | 12 | 1150 | 1070 |
|-------------------------------------|----------|-----|-----|----|-----|----|----|------|------|

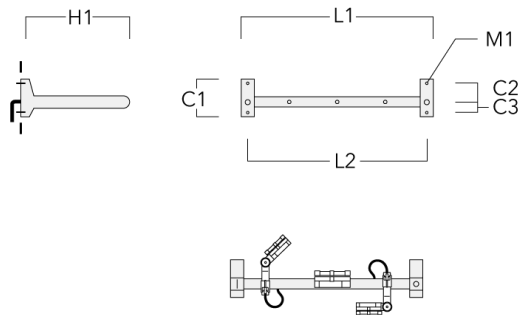

FLC121 LED RAIL66

| Beschreibung | Artikelnummer | C1 | C2 | C3 | H1 | M1 | Gewicht (kg) | L1 | L2 |
|-------------------------------------|---------------|-----|-----|----|-----|----|--------------|------|------|
| für 3 Strahler oder Fluter (L=1650) | 310-9240 | 220 | 120 | 60 | 600 | 13 | 13.30 | 1650 | 1570 |

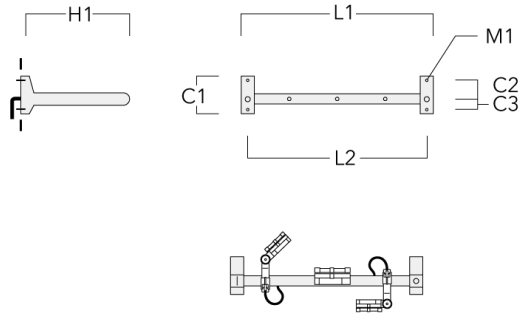

| | | | | | | | | | |
|-------------------------------------|----------|-----|-----|----|-----|----|-------|------|------|
| für 4 Strahler oder Fluter (L=1650) | 310-9242 | 220 | 120 | 60 | 600 | 13 | 13.30 | 1650 | 1570 |
|-------------------------------------|----------|-----|-----|----|-----|----|-------|------|------|

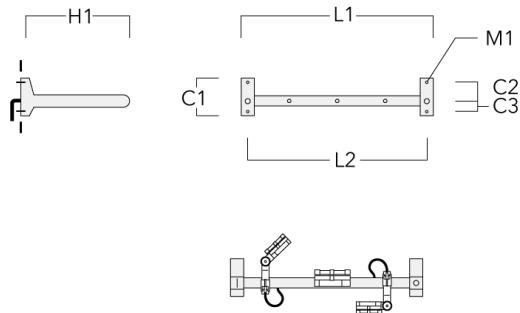

FLC121 LED RAIL66

| Beschreibung | Artikelnummer | C1 | C2 | C3 | H1 | M1 | Gewicht (kg) | L1 | L2 |
|-------------------------------------|---------------|-----|-----|----|-----|----|--------------|------|------|
| für 4 Strahler oder Fluter (L=2150) | 310-9250 | 220 | 120 | 60 | 600 | 13 | 14.60 | 2150 | 2070 |

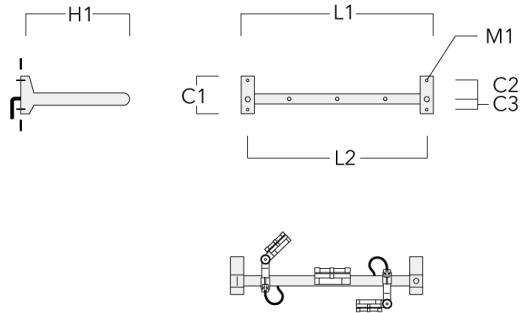

| | | | | | | | | | |
|-------------------------------------|----------|-----|-----|----|-----|----|-------|------|------|
| für 6 Strahler oder Fluter (L=2150) | 310-9252 | 220 | 120 | 60 | 600 | 13 | 14.60 | 2150 | 2070 |
|-------------------------------------|----------|-----|-----|----|-----|----|-------|------|------|

