



Description

IP66, Class I. Class II on request. IK07. Marine-grade, die-cast aluminium alloy. 5CE superior corrosion protection including PCS hardware. Silicone CCG® Controlled Compression Gasket. Safety glass lens. Integral EC electronic converter in thermally separated compartment. CAD-optimised optics for superior illumination and glare control. OLC® One LED Concept. Factory installed LED circuit board.

Including 0,4 m of flexible cable enclosed in stainless conduit, in-line connector and mounting clamp for installation to RAIL66 mounting system.

Weight	3.10 kg
Light distribution	symmetric, medium beam [M]
Light source	LED-12/24W / 700 mA - 2700 K
CRI	80
Power supply	EC
LEDs	12
Rated input power	27 W

Nominal Lumen (lm)

LED Lumen	270
Total Lumen	3240
Tj	85

Rated lumens (lm)

LED Lumen	232.7
Total Lumen	2791.8
Ta	25

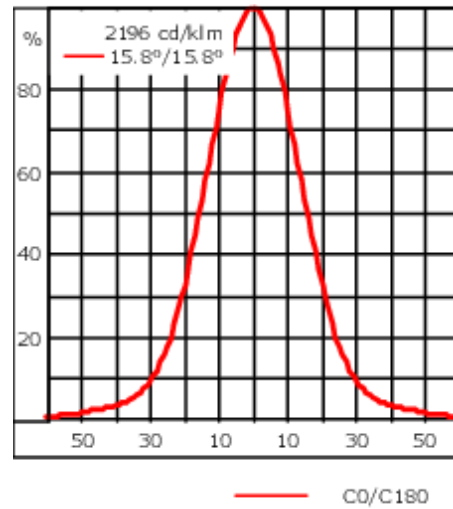

Specifications

Material description

Body	Marine-grade die-cast aluminium alloy
Lens	Safety glass lens
Colours	<div style="display: flex; align-items: center;"> <div style="width: 20px; height: 15px; background-color: black; margin-right: 5px;"></div> <div>RAL9004 Signal black</div> </div> <div style="display: flex; align-items: center; margin-top: 5px;"> <div style="width: 20px; height: 15px; background-color: #cccccc; margin-right: 5px;"></div> <div>RAL9006 White aluminium</div> </div> <div style="display: flex; align-items: center; margin-top: 5px;"> <div style="width: 20px; height: 15px; background-color: #808080; margin-right: 5px;"></div> <div>RAL9007 Grey aluminium</div> </div> <div style="display: flex; align-items: center; margin-top: 5px;"> <div style="width: 20px; height: 15px; background-color: #333333; margin-right: 5px;"></div> <div>RAL7016 Anthracite grey</div> </div> <div style="display: flex; align-items: center; margin-top: 5px;"> <div style="width: 20px; height: 15px; background-color: #e0e0e0; margin-right: 5px;"></div> <div>RAL9016 Traffic white</div> </div>
Gasket	Silicone rubber gasket
Fasteners	PCS Polymer Coated Stainless Steel Hardware
Ingress protection	IP66
Impact resistance	IK07
Corrosion resistance	5CE

Electrical description

Power supply	220-240V / 50-60 Hz
Driver / Ballast	Integral EC electronic converter in thermally-separated compartment
Surge protection	1/2 kV

Additional information

Lifetime	Ta=25° L90B10 > 90000h
Energy efficiency class	C-D (Light source)

WE-EF LEUCHTEN GmbH

Töpinger Straße 16, 29646 Bispingen, Germany - Phone: +49 5194 909-0
 info@we-ef.com - <https://we-ef.com>

Subject to technical changes and errors. - Generated on 23/11/2024

Optical Accessories

Glare shield

Description	Part ID	A	C1
Glare shield ES	146-0156	110	100



Snoot

Description	Part ID	A	C1
Snoot ET	146-0397	95,5	126



Flood lens

Description	Part ID	C1
IO-360	146-0623	110



Linear spread lens

Description	Part ID	C1
IO-180-FLC131-LED	146-0418	110.00

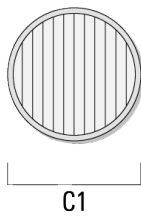

Wallwash lens

Description	Part ID	C1
IO-20-WW-FLC131-LED	146-0645	110

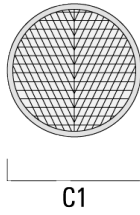

Honeycomb louvre

Description	Part ID	C1
IW-FLC131-LED - [EE][EES]	146-0625	110

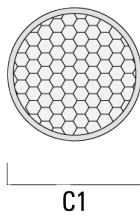

Mounting Accessories

Universal

Description	Part ID	C1	C2	H1	M1	Weight (kg)	L1	L2
2 Mains outlets (L=1150)	310-9200	75	30	200	12	5.90	1150	1045

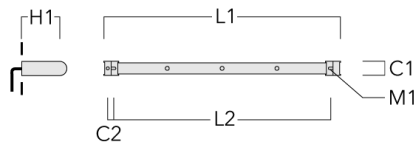

3 Mains outlets (L=1150)	310-9202	75	30	200	12	5.90	1150	1045
--------------------------	----------	----	----	-----	----	------	------	------

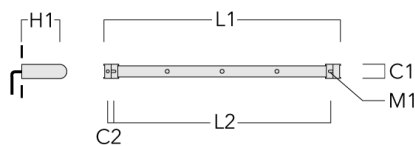

FLC131 LED RAIL66

Description	Part ID	C1	C2	H1	M1	Weight (kg)	L1	L2
3 Mains outlets (L=1650)	310-9210	75	30	200	12	7.20	1650	1545



4 Mains outlets (L=1650)	310-9212	75	30	200	12	7.20	1650	1545
--------------------------	----------	----	----	-----	----	------	------	------



FLC131 LED RAIL66

Description	Part ID	C1	C2	H1	M1	Weight (kg)	L1	L2
4 Mains outlets (L=2150)	310-9220	75	30	200	12	8.50	2150	2045



6 Mains outlets (L=2150)	310-9222	75	30	200	12	8.50	2150	2045
--------------------------	----------	----	----	-----	----	------	------	------



FLC131 LED RAIL66

Flat Surface Fitters

Description	Part ID	C1	C2	D1	D2	L	M1	Weight (kg)
Surface fitters (pair)	310-9290	20	30	180	140	1070	9	1.70

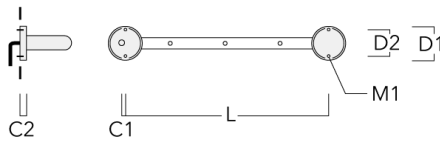

Column Fitters

Description	Part ID	C1	C2	L	M1	Weight (kg)
Column fitters (pair)	310-9294	30	100	1115	12	0.90

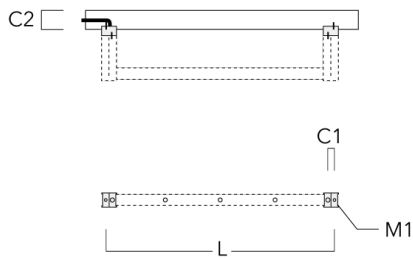

FLC131 LED RAIL66

Cantilever

Description	Part ID	C1	C2	C3	H1	M1	Weight (kg)	L1	L2
2 Mains outlets (L=1150)	310-9230	220	120	60	600	13	12	1150	1070



3 Mains outlets (L=1150)	310-9232	220	120	60	600	13	12	1150	1070
--------------------------	----------	-----	-----	----	-----	----	----	------	------



FLC131 LED RAIL66

Description	Part ID	C1	C2	C3	H1	M1	Weight (kg)	L1	L2
3 Mains outlets (L=1650)	310-9240	220	120	60	600	13	13.30	1650	1570

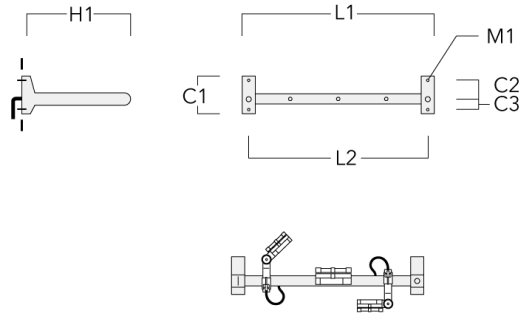

4 Mains outlets (L=1650)	310-9242	220	120	60	600	13	13.30	1650	1570
--------------------------	----------	-----	-----	----	-----	----	-------	------	------

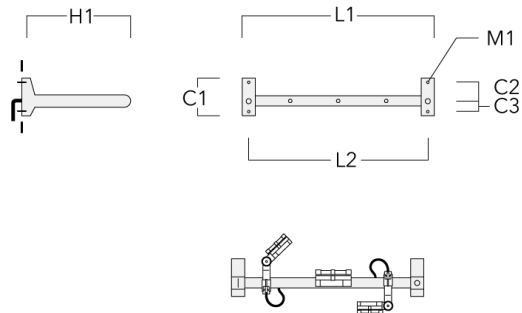

FLC131 LED RAIL66

Description	Part ID	C1	C2	C3	H1	M1	Weight (kg)	L1	L2
4 Mains outlets (L=2150)	310-9250	220	120	60	600	13	14.60	2150	2070



6 Mains outlets (L=2150)	310-9252	220	120	60	600	13	14.60	2150	2070
--------------------------	----------	-----	-----	----	-----	----	-------	------	------

