



Description

IP66, Class I. IK07. Marine-grade, die-cast aluminium alloy. 5CE superior corrosion protection including PCS hardware. Safety glass lens. Silicone CCG® Controlled Compression Gasket. Luminaire is factory-sealed and does not need to be opened during installation.

Integral EC electronic converter in thermally-separated compartment. Advanced thermal management protects LEDs while optimising lumens output. CAD-optimised optics for superior illumination and glare control. OLC® One LED Concept.

Including 0.4 m of flexible cable enclosed in a stainless conduit, in-line connector and mounting clamp for installation to RAIL66 mounting system.

Weight	3.10 kg
Light distribution	symmetric, very narrow beam, sharp cut-off [EES]
Light source	LED-12/24W / 700 mA - 2700 K
CRI	80
Power supply	EC
LEDs	12
Rated input power	27 W
Nominal Lumen (lm)	
LED Lumen	270
Total Lumen	3240
Tj	85
Rated lumens (lm)	
LED Lumen	238.8
Total Lumen	2865.6
Ta	25

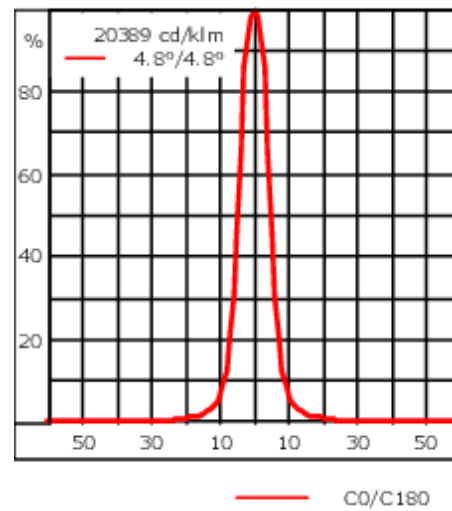
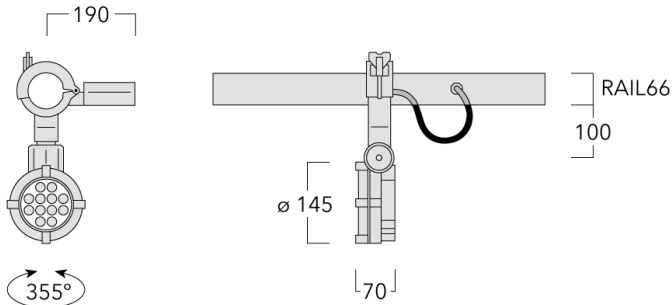

Specifications

Material description

Body	Marine-grade, die-cast aluminium alloy
Lens	Safety glass lens
Colours	<div style="display: flex; align-items: center;"> <div style="width: 20px; height: 15px; background-color: black; margin-right: 5px;"></div> <div>RAL9004 Signal black</div> </div> <div style="display: flex; align-items: center; margin-top: 5px;"> <div style="width: 20px; height: 15px; background-color: grey; margin-right: 5px;"></div> <div>RAL9007 Grey aluminium</div> </div> <div style="display: flex; align-items: center; margin-top: 5px;"> <div style="width: 20px; height: 15px; background-color: darkgrey; margin-right: 5px;"></div> <div>RAL7016 Anthracite grey</div> </div> <div style="display: flex; align-items: center; margin-top: 5px;"> <div style="width: 20px; height: 15px; background-color: lightgrey; margin-right: 5px;"></div> <div>RAL9016 Traffic white</div> </div>
Gasket	Silicone CCG® Controlled Compression Gasket
Fasteners	PCS hardware
Ingress protection	IP66
Impact resistance	IK07
Corrosion resistance	5CE

Electrical description

Power supply	220-240V / 50-60 Hz
Driver / Ballast	Integral EC electronic converter in thermally-separated compartment

Additional information

Lifetime	T _a =25° L90B10 > 90000h
----------	-------------------------------------

Optical Accessories

Glare shield

Description	Part ID	A	C1
Glare shield ES	146-0156	110	100



Snoot

Description	Part ID	A	C1
Snoot ET	146-0397	95,5	126

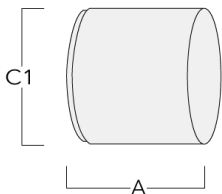

Flood lens

WE-EF LIGHTING (Thailand) Co., Ltd.

57 Moo 5, Kingkaew Rd., Bangplee, 10540 Samutprakarn - Phone: +66 2 738 96 20 - Fax: +66 2 738 96 29

<https://we-ef.com/asia>

Subject to technical changes and errors. - Generated on 23/10/2024

FLC131 LED RAIL66

Description	Part ID	C1
Flood lens IO-360	146-0419	110

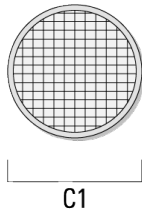

Linear louvre

Description	Part ID	C1
Linear louvre IL	146-9055	110



Linear spread lens

FLC131 LED RAIL66

Description	Part ID	C1
Linear spread lens IO-180	146-0418	110

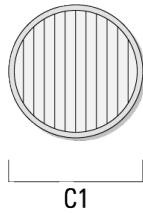

Wallwash lens

Description	Part ID	C1
Wallwash lens IO-20	146-0645	110

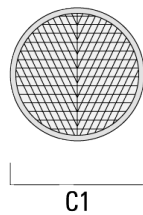

Honeycomb louvre

FLC131 LED RAIL66

Description	Part ID	C1
Honeycomb louvre IW	146-0625	110

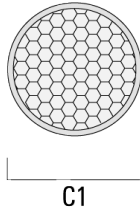

Colour correction filter

Description	Part ID
IF-3000K > 2400K	146-9054

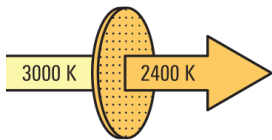

Mounting Accessories

Flat Surface Fitters

Description	Part ID	C1	C2	D1	D2	L	M1	Weight (kg)
Surface fitters (pair)	310-9290	20	30	180	140	1070	9	1.70

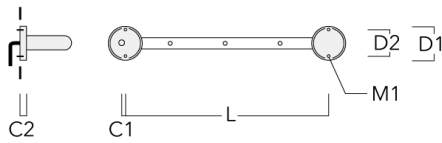

Column Fitters

Description	Part ID	C1	C2	L	M1	Weight (kg)
Column fitters (pair)	310-9294	30	100	1115	12	0.90



Universal

FLC131 LED RAIL66

Description	Part ID	C1	C2	H1	M1	Weight (kg)	L1	L2
2 Mains outlets (L=1150)	310-9300	75	30	200	12	5.90	1150	1045

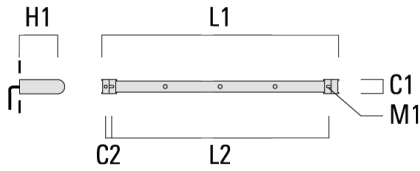

3 Mains outlets (L=1150)	310-9301	75	30	200	12	5.90	1150	1045
--------------------------	----------	----	----	-----	----	------	------	------

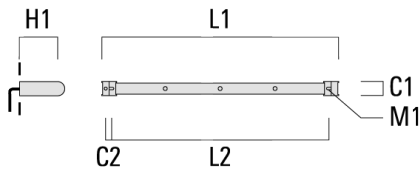

FLC131 LED RAIL66

Description	Part ID	C1	C2	H1	M1	Weight (kg)	L1	L2
3 Mains outlets (L=1650)	310-9302	75	30	200	12	7.20	1650	1545

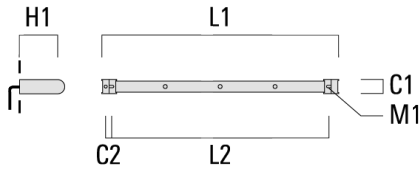

4 Mains outlets (L=1650)	310-9303	75	30	200	12	7.20	1650	1545
--------------------------	----------	----	----	-----	----	------	------	------

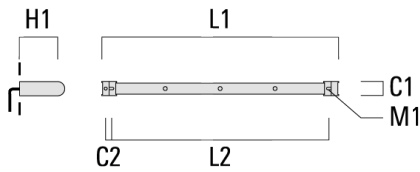

FLC131 LED RAIL66

Description	Part ID	C1	C2	H1	M1	Weight (kg)	L1	L2
4 Mains outlets (L=2150)	310-9304	75	30	200	12	8.50	2150	2045

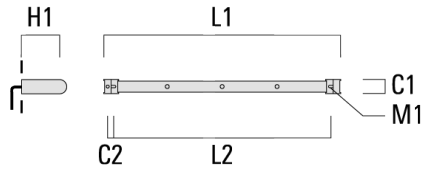

6 Mains outlets (L=2150)	310-9305	75	30	200	12	8.50	2150	2045
--------------------------	----------	----	----	-----	----	------	------	------



Cantilever

FLC131 LED RAIL66

Description	Part ID	C1	C2	C3	H1	M1	Weight (kg)	L1	L2
2 Mains outlets (L=1150)	310-9233	220	120	60	600	13	12.00	1150	1070

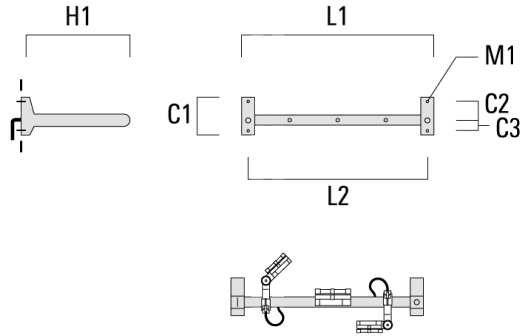

3 Mains outlets (L=1150)	310-9234	220	120	60	600	13	12.00	1150	1070
--------------------------	----------	-----	-----	----	-----	----	-------	------	------



FLC131 LED RAIL66

Description	Part ID	C1	C2	C3	H1	M1	Weight (kg)	L1	L2
3 Mains outlets (L=1650)	310-9243	220	120	60	600	13	13.30	1650	1570

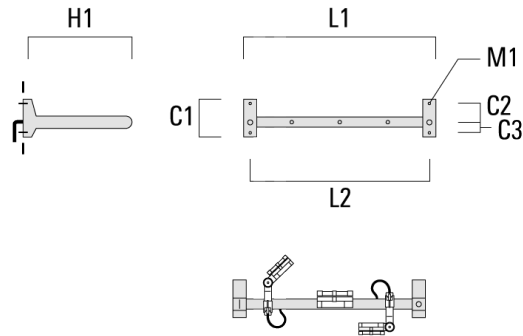

4 Mains outlets (L=1650)	310-9244	220	120	60	600	13	13.30	1650	1570
--------------------------	----------	-----	-----	----	-----	----	-------	------	------

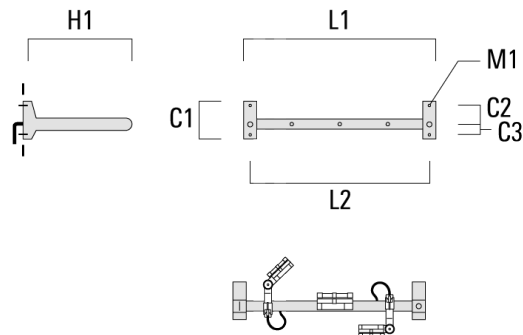

FLC131 LED RAIL66

Description	Part ID	C1	C2	C3	H1	M1	Weight (kg)	L1	L2
4 Mains outlets (L=2150)	310-9255	220	120	60	600	13	14.60	2150	2070

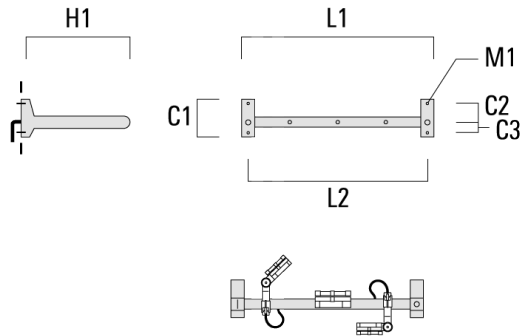

6 Mains outlets (L=2150)	310-9256	220	120	60	600	13	14.60	2150	2070
--------------------------	----------	-----	-----	----	-----	----	-------	------	------



146-0983

FLC131 LED RAIL66

WE-EF LIGHTING (Thailand) Co., Ltd.

57 Moo 5, Kingkaew Rd., Bangplee, 10540 Samutprakarn

Phone: +66 2 738 96 20

Fax: +66 2 738 96 29

<https://we-ef.com/asia>

Subject to technical changes and errors.

Generated on 23/10/2024