



Description

IP66. Classe I. Classe II sur demande. IK07. Corps en fonte d'aluminium. Visserie inox avec traitement PCS. Protection contre la corrosion 5CE. Joint silicone. Verre de sécurité. Lentilles LED en PMMA.

Alimentation électronique dans un boîtier thermique séparé. Livré avec 40cm de câble pour branchement direct sur notre système RAIL66.

Poids	3.10 kg
Distribution de la lumière	faisceau ovalisante, ultra intensif [EE]
Source lumineuse	LED-12/24W / 700 mA - 2700 K
IRC	80
Alimentation électrique	ballast électronique
LEDs	12
Rated input power	27 W
Flux lumineux nominal (lm)	
LED Lumen	270
Total Lumen	3240
Tj	85
Rated lumens (lm)	
LED Lumen	212.9
Total Lumen	2554.9
Ta	25

WE-EF Switzerland AG

Himmelrichstrasse 6, 6003 Luzern - Téléphone: +41 22 752 49 94

info.switzerland@we-ef.com - https://we-ef.com/ch_fr

Sous réserve de modifications techniques et d'erreurs. - Généré le 23/11/2024

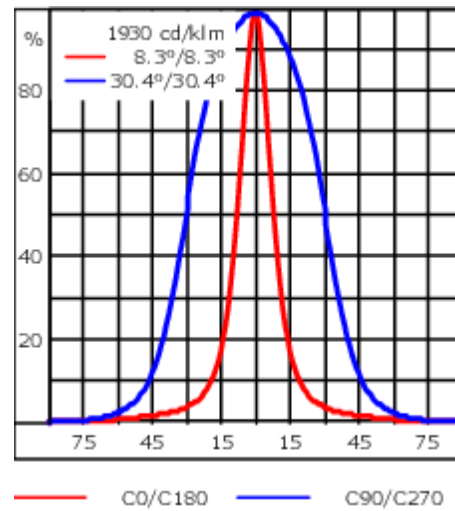

Spécifications

Description du matériel

Corps	Corps en fonte d'aluminium, visserie inox avec traitement PCS
Lentille	Verre de sécurité
Couleurs	<div style="display: flex; align-items: center;"> <div style="width: 20px; height: 15px; background-color: black; margin-right: 5px;"></div> RAL9004 Noir de sécurité </div> <div style="display: flex; align-items: center; margin-top: 5px;"> <div style="width: 20px; height: 15px; background-color: gray; margin-right: 5px;"></div> RAL9007 Aluminium gris </div> <div style="display: flex; align-items: center; margin-top: 5px;"> <div style="width: 20px; height: 15px; background-color: darkgray; margin-right: 5px;"></div> RAL7016 Gris anthracite </div> <div style="display: flex; align-items: center; margin-top: 5px;"> <div style="width: 20px; height: 15px; background-color: lightgray; margin-right: 5px;"></div> RAL9016 Blanc signalisation </div>
Joint	Joint silicone
Visserie	PCS Inox avec revêtement polymère
IP	IP66
IK	IK07
Protection contre la corrosion	5CE

Description électrique

Alimentation électrique	220-240V / 50-60 Hz
Driver	Driver électronique séparé thermiquement

WE-EF Switzerland AG

Himmelrichstrasse 6, 6003 Luzern - Téléphone: +41 22 752 49 94

info.switzerland@we-ef.com - https://we-ef.com/ch_fr

Sous réserve de modifications techniques et d'erreurs. - Généré le 23/11/2024

146-0982+146-0418

we-ef

FLC131 LED RAIL66

Informations complémentaires

Durée de vie Ta=25° L90B10 > 90000h

Classe d'efficacité
énergétique C-D

WE-EF Switzerland AG

Himmelrichstrasse 6, 6003 Luzern - Téléphone: +41 22 752 49 94

info.switzerland@we-ef.com - https://we-ef.com/ch_fr

Sous réserve de modifications techniques et d'erreurs. - Généré le 23/11/2024

Accessoires Optiques

Visière

Description	Référence	A	C1
Visière ES	146-0156	110	100



Canon anti-éblouissement

Description	Référence	A	C1
Canon anti-éblouissement ET	146-0397	95,5	126



FLC131 LED RAIL66

Lentille e'largissante

Description	Référence	C1
IO-360	146-0623	110



Lentille ovalisante

Description	Référence	C1
IO-180-FLC131-LED	146-0418	110

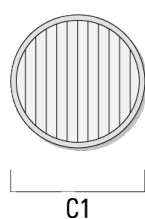

FLC131 LED RAIL66

Lentille rasante

Description	Référence	C1
IO-20-WW-FLC131-LED	146-0645	110

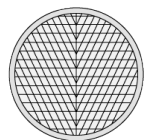

C1

Grille nid d'abeille

Description	Référence	C1
IW-FLC131-LED - [EE][EES]	146-0625	110

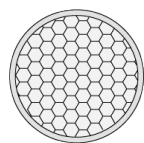

C1

WE-EF Switzerland AG

Himmelrichstrasse 6, 6003 Luzern - Téléphone: +41 22 752 49 94

info.switzerland@we-ef.com - https://we-ef.com/ch_fr

Sous réserve de modifications techniques et d'erreurs. - Généré le 23/11/2024

FLC131 LED RAIL66

Accessoires d'installation

Universal

Description	Référence	C1	C2	H1	M1	Poids (kg)	L1	L2
Rail 66 système universel pour 2 projecteurs maxi (L=1150)	310-9200	75	30	200	12	5.90	1150	1045

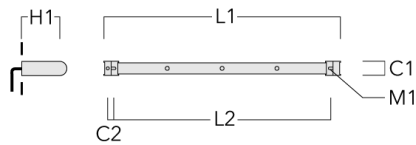

Rail 66 système universel pour 3 projecteurs maxi (L=1150)	310-9202	75	30	200	12	5.90	1150	1045
--	----------	----	----	-----	----	------	------	------

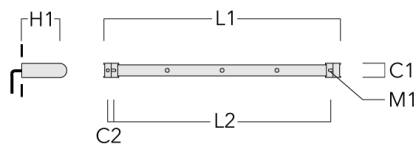

FLC131 LED RAIL66

Description	Référence	C1	C2	H1	M1	Poids (kg)	L1	L2
Rail 66 système universel pour 3 projecteurs maxi (L=1650)	310-9210	75	30	200	12	7.20	1650	1545

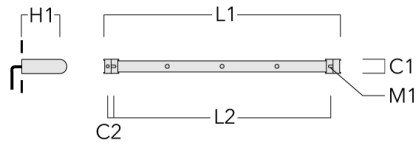

Rail 66 système universel pour 4 projecteurs maxi (L=1650)	310-9212	75	30	200	12	7.20	1650	1545
--	----------	----	----	-----	----	------	------	------

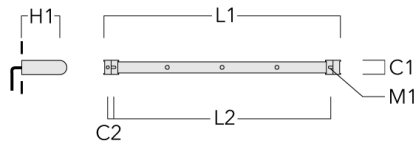

FLC131 LED RAIL66

Description	Référence	C1	C2	H1	M1	Poids (kg)	L1	L2
Rail 66 système universel pour 4 projecteurs maxi (L=2150)	310-9220	75	30	200	12	8.50	2150	2045

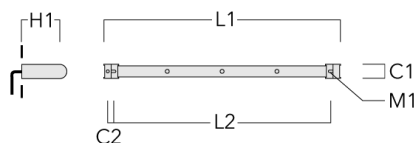

Rail 66 système universel pour 6 projecteurs maxi (L=2150)	310-9222	75	30	200	12	8.50	2150	2045
--	----------	----	----	-----	----	------	------	------

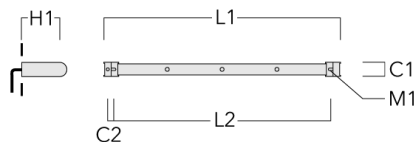

FLC131 LED RAIL66

Cache (paire)

Description	Référence	C1	C2	D1	D2	L	M1	Poids (kg)
Paire de cache pour rail66	310-9290	20	30	180	140	1070	9	1.70

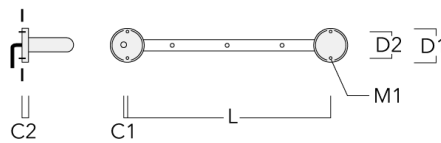

Adaptateur pour fixation

Description	Référence	C1	C2	L	M1	Poids (kg)
Adaptateur pour fixation (paire)	310-9294	30	100	1115	12	0.90

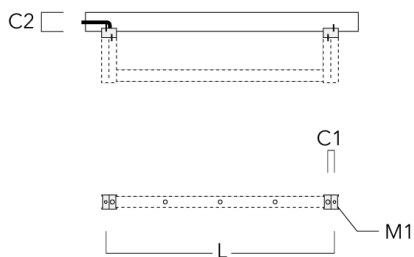

FLC131 LED RAIL66

Crosse

Description	Référence	C1	C2	C3	H1	M1	Poids (kg)	L1	L2
Rail 66 crosse pour 2 projecteurs maxi (L=1150)	310-9230	220	120	60	600	13	12	1150	1070

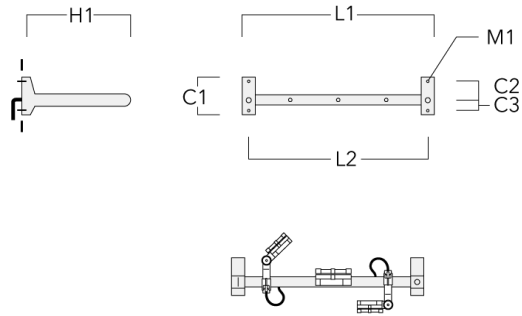

Rail 66 crosse pour 3 projecteurs maxi (L=1150)	310-9232	220	120	60	600	13	12	1150	1070
--	----------	-----	-----	----	-----	----	----	------	------

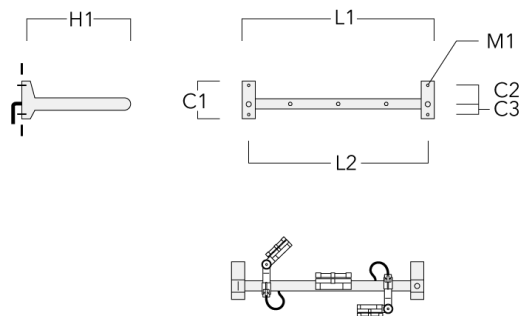

FLC131 LED RAIL66

Description	Référence	C1	C2	C3	H1	M1	Poids (kg)	L1	L2
Rail 66 crosse pour 3 projecteurs maxi (L=1650)	310-9240	220	120	60	600	13	13.30	1650	1570

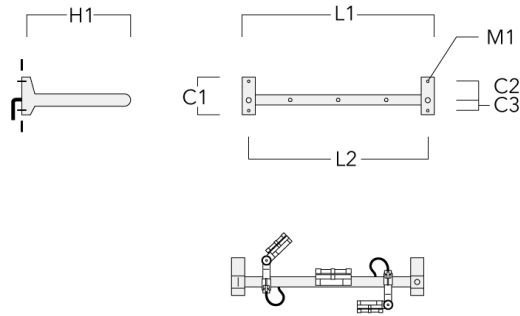

Rail 66 crosse pour 4 projecteurs maxi (L=1650)	310-9242	220	120	60	600	13	13.30	1650	1570
--	----------	-----	-----	----	-----	----	-------	------	------

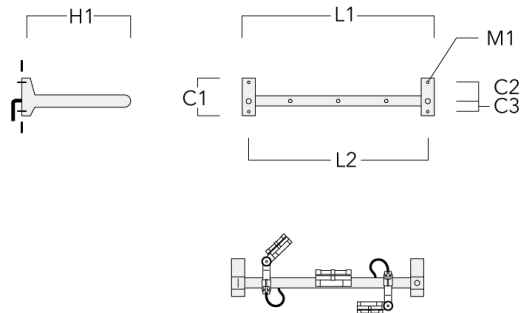

FLC131 LED RAIL66

Description	Référence	C1	C2	C3	H1	M1	Poids (kg)	L1	L2
Rail 66 crosse pour 4 projecteurs maxi (L=2150)	310-9250	220	120	60	600	13	14.60	2150	2070

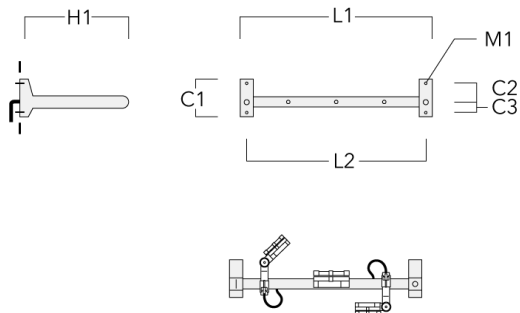

Rail 66 crosse pour 6 projecteurs maxi (L=2150)	310-9252	220	120	60	600	13	14.60	2150	2070
--	----------	-----	-----	----	-----	----	-------	------	------

