

115-1565

LTM440 LED-FT

we-ef



Description

IP66, Class I. Class II on request. IK10. Marine-grade die-cast aluminium alloy. 5CE superior corrosion protection including PCS hardware. Silicone CCG® Controlled Compression Gasket. Polycarbonate main lens. CAD-optimised optics for superior illumination and glare control.

Service door with fused cable connecting box.

Weight	25.00 kg
Light distribution	controlled symmetric distribution [C50]
Light source	LED-FT-37W / 700 mA - 3000 K
CRI	80
Power supply	EC
LEDs	1
Rated input power	42 W
Rated lumens (lm)	
LED Lumen	5171.3
Total Lumen	5171.3
Ta	25
Nominal Lumen (lm)	
LED Lumen	6330
Total Lumen	6330
Tc	25

WE-EF LEUCHTEN GmbH

Töpinger Straße 16, 29646 Bispingen, Germany - Phone: +49 5194 909-0
info@we-ef.com - <https://we-ef.com>

Subject to technical changes and errors. - Generated on 23/11/2024

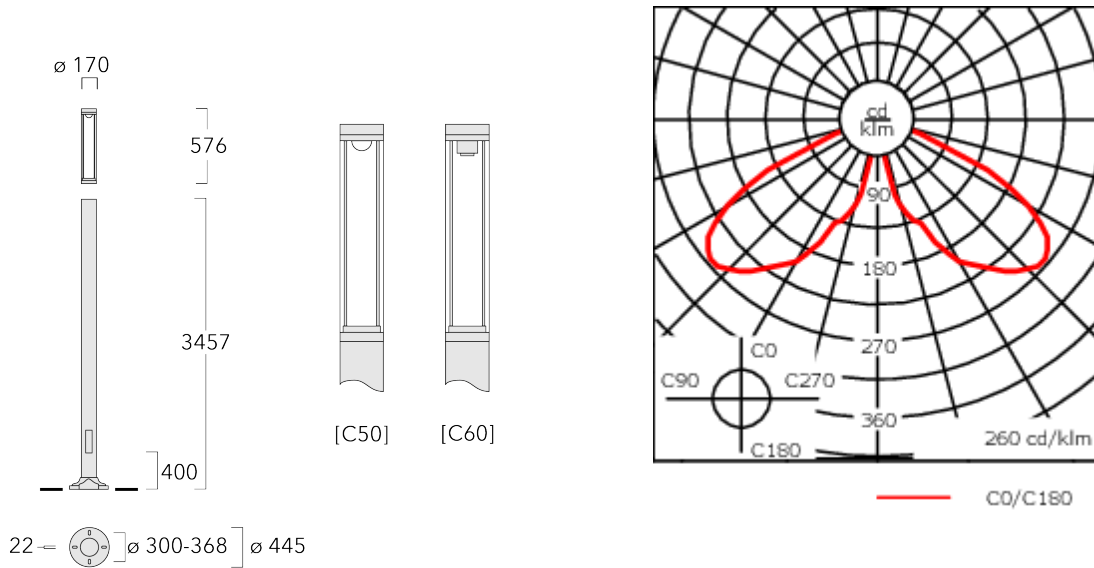

Specifications

Material description

Body	Marine-grade, all-aluminium construction
Lens	Polycarbonate lens
Colours	<ul style="list-style-type: none"> RAL9004 Signal black RAL9006 White aluminium RAL9007 Grey aluminium RAL7016 Anthracite grey RAL9016 Traffic white
Gasket	Silicone CCG® Controlled Compression Gasket
Fasteners	PCS Polymer Coated Stainless Steel hardware
Ingress protection	IP66
Impact resistance	IK10
Corrosion resistance	5CE

Electrical description

Power supply	220-240V / 50-60 Hz
Driver / Ballast	Integral EC electronic converter
Surge protection	10/10kV

Additional information

Lifetime	Ta=25° L70B50 > 50000h
Energy efficiency class	B-C (Light source)

WE-EF LEUCHTEN GmbH

Töpinger Straße 16, 29646 Bispingen, Germany - Phone: +49 5194 909-0
 info@we-ef.com - <https://we-ef.com>

Subject to technical changes and errors. - Generated on 23/11/2024

Mounting Accessories

Planted root

Description	Part ID	D1	D2	D3	D4	H1	H2	M1	Weight (kg)
Planted root ESV10	300-0949	415	340	126	133	1000	500	18	25.30



115-1565

LTM440 LED-FT

we-ef

Optical Accessories

Light shield

Description	Part ID
LS180-[C60]	159-0321

WE-EF LEUCHTEN GmbH

Töpinger Straße 16, 29646 Bispingen, Germany - Phone: +49 5194 909-0
info@we-ef.com - <https://we-ef.com>

Subject to technical changes and errors. - Generated on 23/11/2024