



### Description

IP66, Class I. Class II on request. IK10. Marine-grade die-cast aluminium alloy. 5CE superior corrosion protection including PCS hardware. Silicone CCG® Controlled Compression Gasket. Polycarbonate main lens. CAD-optimised optics for superior illumination and glare control.

Service door with fused cable connecting box.

Weight	25.00 kg
Light distribution	symmetric distribution [C60]
Light source	LED-FT-37W / 700 mA - 4000 K
CRI	80
Power supply	EC
LEDs	1
Rated input power	42 W

### Rated lumens (lm)

LED Lumen	4516.7
Total Lumen	4516.7
Ta	25

### Nominal Lumen (lm)

LED Lumen	6695
Total Lumen	6695
Tc	25

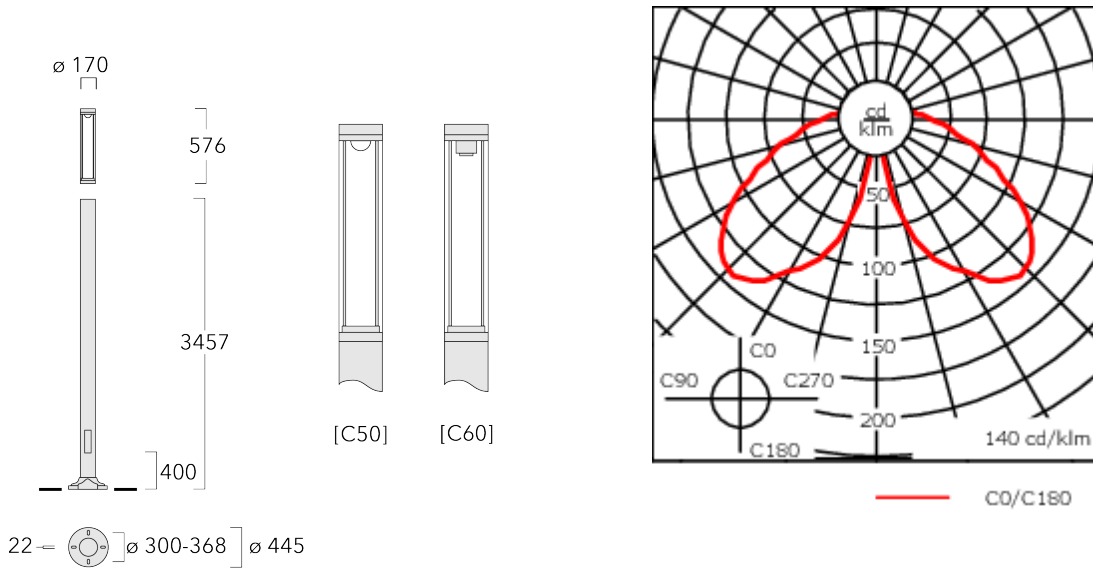

## Specifications

### Material description

Body	Marine-grade, all-aluminium construction
Lens	Polycarbonate lens
Colours	<ul style="list-style-type: none"> <li><span style="display: inline-block; width: 15px; height: 15px; background-color: black; margin-right: 5px;"></span> RAL9004 Signal black</li> <li><span style="display: inline-block; width: 15px; height: 15px; background-color: #cccccc; margin-right: 5px;"></span> RAL9006 White aluminium</li> <li><span style="display: inline-block; width: 15px; height: 15px; background-color: #808080; margin-right: 5px;"></span> RAL9007 Grey aluminium</li> <li><span style="display: inline-block; width: 15px; height: 15px; background-color: #333333; margin-right: 5px;"></span> RAL7016 Anthracite grey</li> <li><span style="display: inline-block; width: 15px; height: 15px; background-color: #e0e0e0; margin-right: 5px;"></span> RAL9016 Traffic white</li> </ul>
Gasket	Silicone CCG® Controlled Compression Gasket
Fasteners	PCS Polymer Coated Stainless Steel hardware
Ingress protection	IP66
Impact resistance	IK10
Corrosion resistance	5CE

### Electrical description

Power supply	220-240V / 50-60 Hz
Driver / Ballast	Integral EC electronic converter
Surge protection	10/10kV

### Additional information

Lifetime	Ta=25° L70B50 > 50000h
Energy efficiency class	B-C (Light source)

**WE-EF LEUCHTEN GmbH**

Töpinger Straße 16, 29646 Bispingen, Germany - Phone: +49 5194 909-0

info@we-ef.com - <https://we-ef.com>

Subject to technical changes and errors. - Generated on 23/10/2024

**Mounting Accessories**

**Planted root**

Description	Part ID	D1	D2	D3	D4	H1	H2	M1	Weight (kg)
Planted root ESV10	300-0949	415	340	126	133	1000	500	18	25.30

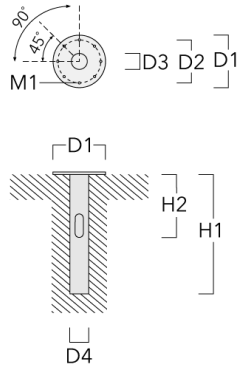

**115-1564**

**LTM440 LED-FT**

**we-ef**

## **Optical Accessories**

### **Light shield**

Description	Part ID
LS180-[C60]	159-0321

**WE-EF LEUCHTEN GmbH**

Töpinger Straße 16, 29646 Bispingen, Germany - Phone: +49 5194 909-0

info@we-ef.com - <https://we-ef.com>

Subject to technical changes and errors. - Generated on 23/10/2024

**115-1564**

**LTM440 LED-FT**

**WE-EF LEUCHTEN GmbH**

Töpinger Straße 16, 29646 Bispingen, Germany

Phone: +49 5194 909-0

[info@we-ef.com](mailto:info@we-ef.com)

<https://we-ef.com>

Subject to technical changes and errors.

Generated on 23/10/2024