

127-1420

AOP534 LED-FT

we-ef



Description

IP55, Class I. IK10. Marine-grade, die-cast aluminium alloy. 5CE superior corrosion protection including PCS hardware. Polycarbonate lens. Silicone rubber gasket.

Integral EC electronic converter. DALI interface. CAD-optimised lens for superior illumination and glare control.

Weight	7.60 kg
Light distribution	symmetric distribution [C60]
Light source	LED-FT-24W / 700 mA - 2700 K
CRI	80
Power supply	EC
BUG	B1 U2 G1
LEDs	1
Rated input power	27 W

Rated lumens (lm)

LED Lumen	2769.2
Total Lumen	2769.2
Ta	25

Nominal Lumen (lm)

LED Lumen	4050
Total Lumen	4050
Tc	25

WE-EF LIGHTING (Thailand) Co., Ltd.

57 Moo 5, Kingkaew Rd., Bangplee, 10540 Samutprakarn - Phone: +66 2 738 96 20 - Fax: +66 2 738 96 29

<https://we-ef.com/asia>

Subject to technical changes and errors. - Generated on 23/10/2024

127-1420



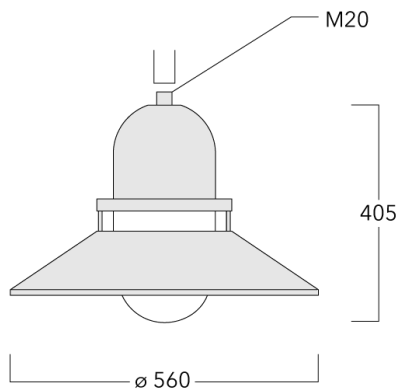

AOP534 LED-FT

we-ef



Specifications

Material description

Body	Marine-grade, die-cast aluminium alloy
Lens	Polycarbonate lens
Colours	 RAL9004 Signal black  RAL9007 Grey aluminium  RAL7016 Anthracite grey  RAL9016 Traffic white
Gasket	Silicone rubber gasket
Fasteners	PCS hardware
Ingress protection	IP55
Impact resistance	IK10
Corrosion resistance	5CE
Windage	0.12 m ²

Electrical description

Power supply	220-240V / 50-60 Hz
Driver / Ballast	Integral electronic converter with DALI interface
Power factor	> 0.9

Additional information

Lifetime	Ta=25° L70B50 > 50000h
BUG Rating	Please see individual Spec Sheets for classification of Backlight, Uplight and Glare

WE-EF LIGHTING (Thailand) Co., Ltd.

57 Moo 5, Kingkaew Rd., Bangplee, 10540 Samutprakarn - Phone: +66 2 738 96 20 - Fax: +66 2 738 96 29

<https://we-ef.com/asia>

Subject to technical changes and errors. - Generated on 23/10/2024

Mounting Accessories

Wall and pole brackets BA

Description	Part ID	C1	D x L1	H1	H2	M1	Weight (kg)	C	H
Wall bracket BA0-420, single	300-0152	460		1000	132	9	2	460	1000

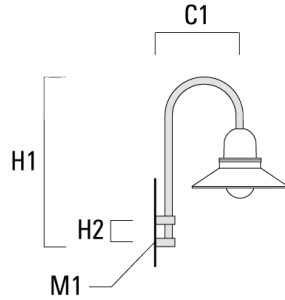

Pole bracket BA1-420, single	300-0099	420	76 x 80	1000			4	420	1000
------------------------------	----------	-----	---------	------	--	--	---	-----	------

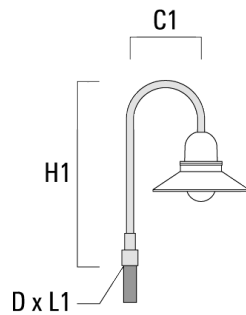

AOP534 LED-FT

Description	Part ID	C1	D x L1	H1	H2	M1	Weight (kg)	C	H
Pole bracket BA2-420, double	300-0104	500	76 x 80	1000			8	500	1000

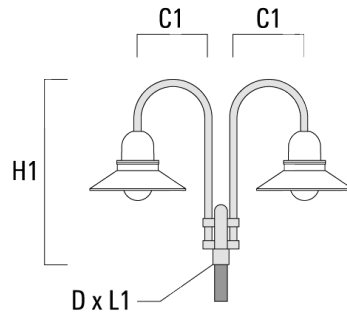

Pole bracket BA3-420, triple	300-0109	500	76 x 80	1000			10	500	1000
------------------------------	----------	-----	---------	------	--	--	----	-----	------

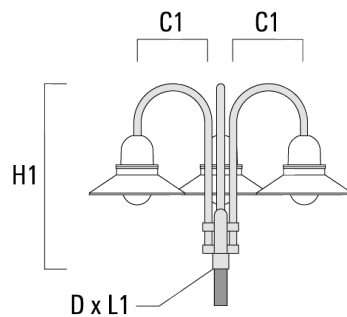

Wall and pole brackets BC

AOP534 LED-FT

Description	Part ID	C1	H1	H2	M1	Weight (kg)	C	H
BC0-420 Wall bracket, single	300-0808	460	1230	300	8	2.30	460	1230

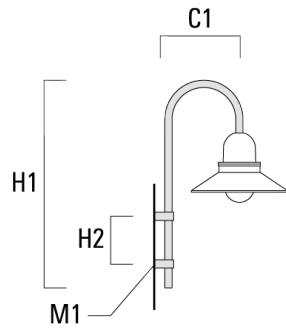

BC1-420 Pole bracket, single	300-0768	500	1230	300	8	2.30	500	1230
------------------------------	----------	-----	------	-----	---	------	-----	------

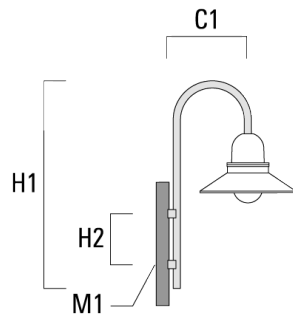

AOP534 LED-FT

Description	Part ID	C1	H1	H2	M1	Weight (kg)	C	H
BC2-420 Pole bracket, double	300-0767	500	1230	300	8	4.60	500	1230

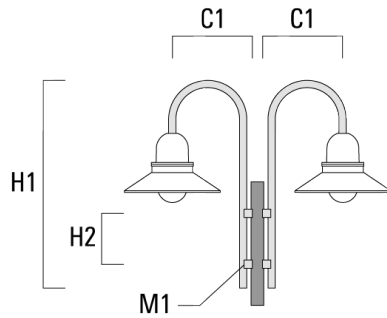

Wall and pole brackets DA

Description	Part ID	C1	C2	D × L1	H1	Weight (kg)	C	H
Wall bracket DA0-500, single	300-0146	510	70		650	5.70	510	650

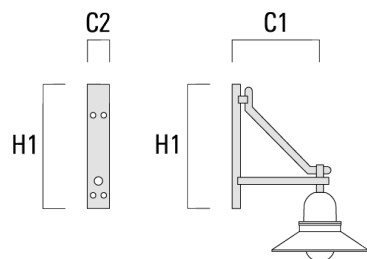

AOP534 LED-FT

Description	Part ID	C1	C2	D × L1	H1	Weight (kg)	C	H
Pole bracket DA1-500, single	300-0138	510		76 x 80	700	5.70	510	700

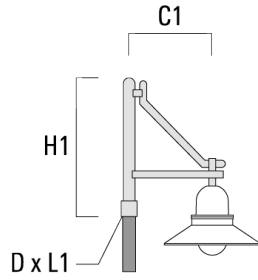

Pole bracket DA2-500, double	300-0141	510		76 x 80	700	8.30	510	700
------------------------------	----------	-----	--	---------	-----	------	-----	-----

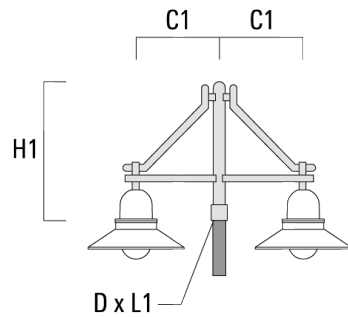

AOP534 LED-FT

Description	Part ID	C1	C2	D × L1	H1	Weight (kg)	C	H
Pole bracket DA3-500, triple	300-0144	510		76 x 80	700	10.90	510	700

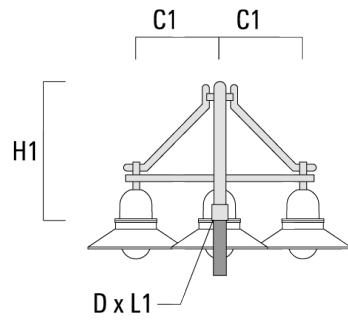

Wall and pole brackets DB

Description	Part ID	C1	C2	D × L1	H1	Weight (kg)	C	H
Wall bracket DB0-500, single	300-0169	510	70		650	5.50	510	650

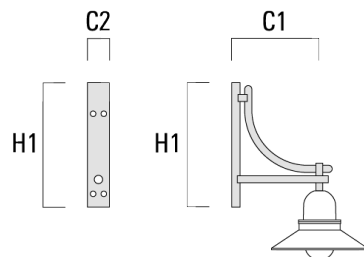

AOP534 LED-FT

Description	Part ID	C1	C2	D × L1	H1	Weight (kg)	C	H
Pole bracket DB1-500, single	300-0190	510		76 x 80	700	5.50	510	700

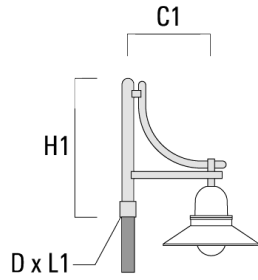

Pole bracket DB2-500, double	300-0191	510		76 x 80	700	7.90	510	700
------------------------------	----------	-----	--	---------	-----	------	-----	-----

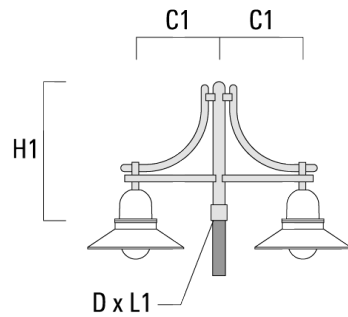

AOP534 LED-FT

Description	Part ID	C1	C2	D × L1	H1	Weight (kg)	C	H
Pole bracket DB3-500, triple	300-0192	510		76 x 80	700	10.30	510	700

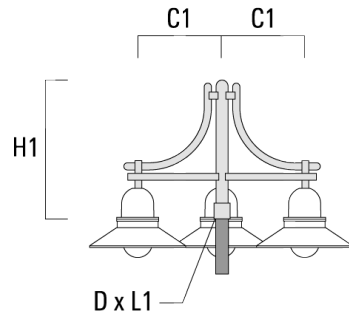

Wall and pole brackets DS

Description	Part ID	C1	C2	D × L1	H1	Weight (kg)	C	H
Wall bracket DS0-500, single	300-0064	510	70		650	2.50	510	650

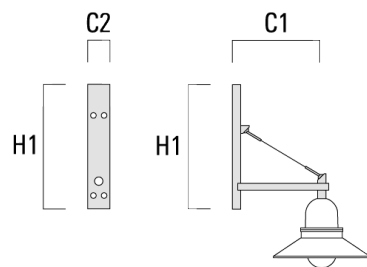

AOP534 LED-FT

Description	Part ID	C1	C2	D × L1	H1	Weight (kg)	C	H
Pole bracket DS1-500, single	300-0063	510		76 x 80	725	3.90	510	725

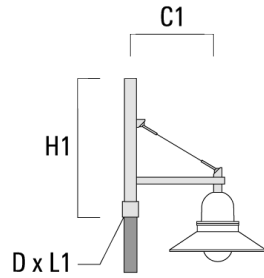

Pole bracket DS2-500, double	300-0066	510		76 x 80	725	5.30	510	725
------------------------------	----------	-----	--	---------	-----	------	-----	-----

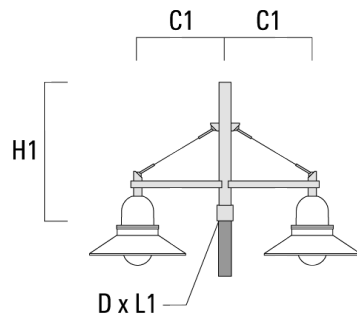

127-1420

AOP534 LED-FT

we-ef

Description	Part ID	C1	C2	D x L1	H1	Weight (kg)	C	H
Pole bracket DS3-500, triple	300-0069	510		76 x 80	725	6.70	510	725

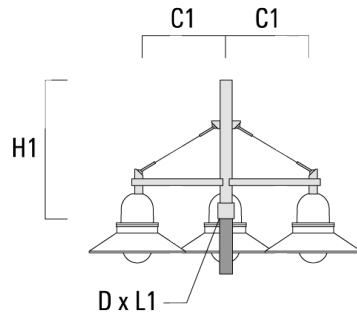

WE-EF LIGHTING (Thailand) Co., Ltd.

57 Moo 5, Kingkaew Rd., Bangplee, 10540 Samutprakarn - Phone: +66 2 738 96 20 - Fax: +66 2 738 96 29

<https://we-ef.com/asia>

Subject to technical changes and errors. - Generated on 23/10/2024

127-1420

AOP534 LED-FT

WE-EF LIGHTING (Thailand) Co., Ltd.

57 Moo 5, Kingkaew Rd., Bangplee, 10540 Samutprakarn

Phone: +66 2 738 96 20

Fax: +66 2 738 96 29

<https://we-ef.com/asia>

Subject to technical changes and errors.

Generated on 23/10/2024