

127-1425

ASP544 LED

we-ef



Description

IP55, Class I. Class II on request. IK10. Marine-grade, die-cast aluminium alloy. 5CE superior corrosion protection including PCS hardware. Silicone rubber gasket. Polycarbonate main lens. Integral EC electronic converter in thermally separated compartment. CAD-optimised optics for superior illumination and glare control. OLC® One LED Concept. Factory installed LED circuit board.

Optional 2200 K version available. To be specified at time of ordering.

Brackets to be ordered separately.

Weight	13.30 kg
Light distribution	asymmetric, side throw beam [S65]
Light source	LED-24/48W / 700 mA - 2700 K
CRI	80
Power supply	EC
LEDs	24
Rated input power	54 W
Nominal Lumen (lm)	
LED Lumen	270
Total Lumen	6480
Tj	85
Rated lumens (lm)	
LED Lumen	229.7
Total Lumen	5512.6
Ta	25

WE-EF LEUCHTEN GmbH

Töpinger Straße 16, 29646 Bispingen, Germany - Phone: +49 5194 909-0
info@we-ef.com - <https://we-ef.com>

Subject to technical changes and errors. - Generated on 23/11/2024

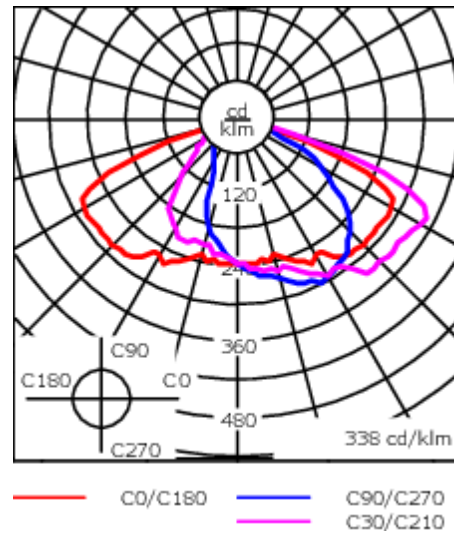
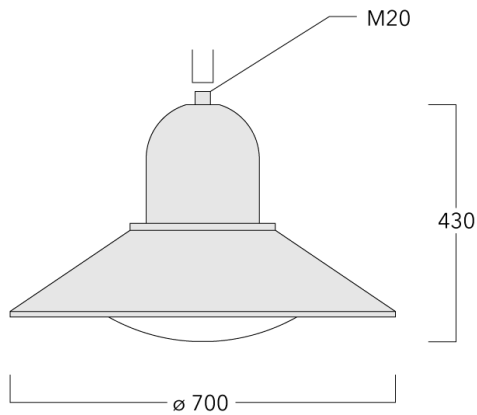

Specifications

Material description

Body	Marine-grade, die-cast aluminium alloy
Lens	Polycarbonate lens
Colours	<div style="display: flex; align-items: center;"> <div style="width: 20px; height: 20px; background-color: black; margin-right: 5px;"></div> RAL9004 Signal black </div> <div style="display: flex; align-items: center; margin-top: 5px;"> <div style="width: 20px; height: 20px; background-color: #cccccc; margin-right: 5px;"></div> RAL9006 White aluminium </div> <div style="display: flex; align-items: center; margin-top: 5px;"> <div style="width: 20px; height: 20px; background-color: #808080; margin-right: 5px;"></div> RAL9007 Grey aluminium </div> <div style="display: flex; align-items: center; margin-top: 5px;"> <div style="width: 20px; height: 20px; background-color: #333333; margin-right: 5px;"></div> RAL7016 Anthracite grey </div> <div style="display: flex; align-items: center; margin-top: 5px;"> <div style="width: 20px; height: 20px; background-color: #e0e0e0; margin-right: 5px;"></div> RAL9016 Traffic white </div>
Gasket	Silicone rubber gasket
Fasteners	PCS Polymer Coated Stainless Steel Hardware
Ingress protection	IP55
Impact resistance	IK10
Corrosion resistance	5CE
Windage	0.1343 m ²

Electrical description

Power supply	220-240V / 50-60 Hz
Driver / Ballast	Integral EC electronic converter. DALI
Power factor	> 0.9
Surge protection	6/6 kV (optional SP10)

WE-EF LEUCHTEN GmbH

Töpinger Straße 16, 29646 Bispingen, Germany - Phone: +49 5194 909-0

info@we-ef.com - <https://we-ef.com>

Subject to technical changes and errors. - Generated on 23/11/2024

127-1425

ASP544 LED

we-ef

Additional information

Lifetime Ta=25° L90B10 > 90000h

Energy efficiency class C-D (Light source)

WE-EF LEUCHTEN GmbH

Töpinger Straße 16, 29646 Bispingen, Germany - Phone: +49 5194 909-0
info@we-ef.com - <https://we-ef.com>

Subject to technical changes and errors. - Generated on 23/11/2024

127-1425

ASP544 LED

we-ef

Control

Eco Step Dim® Basic

Description	Part ID
Eco Step Dim® Basic LED	430-0001

Eco Step Dim® Advanced

Description	Part ID
Eco Step Dim® Advanced LED	430-0002

WE-EF LEUCHTEN GmbH

Töpinger Straße 16, 29646 Bispingen, Germany - Phone: +49 5194 909-0
info@we-ef.com - <https://we-ef.com>

Subject to technical changes and errors. - Generated on 23/11/2024

Mounting Accessories

Wall and pole brackets BA

Description	Part ID	C1	D × L1	H1	H2	M1	Weight (kg)	C	H
BA0-580 Wall bracket, single	300-0149	635		1000	132	9	2.50	635	1000

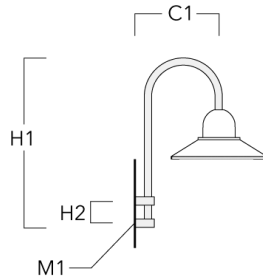

BA1-580 Pole bracket, single	300-0089	580	76 x 80	1000			4.50	580	1000
------------------------------	----------	-----	---------	------	--	--	------	-----	------

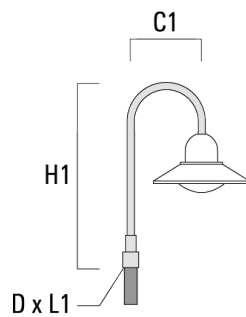

ASP544 LED

Description	Part ID	C1	D x L1	H1	H2	M1	Weight (kg)	C	H
BA2-580 Pole bracket, double	300-0090	675	76 x 80	1000			8.50	675	1000



BA3-580 Pole bracket, triple	300-0093	675	76 x 80	1000			10.50	675	1000
------------------------------	----------	-----	---------	------	--	--	-------	-----	------

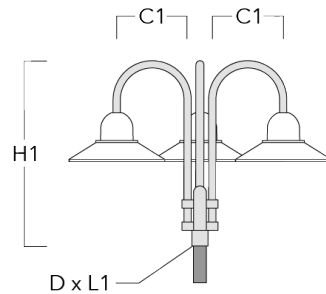

Wall and pole brackets BC

Description	Part ID	C1	H1	H2	M1	Weight (kg)	C	H
BC0-580 Wall bracket, double	300-0771	635	1325	300	8	2.80	635	1325

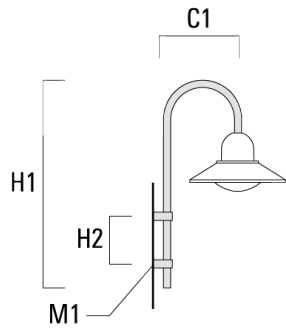

BC1-580 Pole bracket, single	300-0770	675	1325	300	8	2.80	675	1325
------------------------------	----------	-----	------	-----	---	------	-----	------

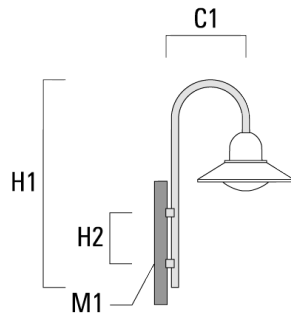

Description	Part ID	C1	H1	H2	M1	Weight (kg)	C	H
BC2-580 Pole bracket, double	300-0769	675	1325	300	8	5.60	675	1325



Wall and pole brackets DA

Description	Part ID	C1	C2	D × L1	H1	Weight (kg)	C	H
DA0-750 Wall bracket, single	300-0086	720	70		950	7.30	720	950

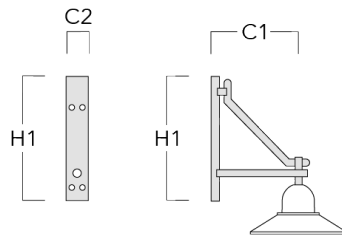

Description	Part ID	C1	C2	D x L1	H1	Weight (kg)	C	H
DA1-750 Pole bracket, single	300-0083	720		76 x 130	950	7.30	720	950



DA2-750 Pole bracket, double	300-0084	720		76 x 130	950	10.60	720	950
------------------------------	----------	-----	--	----------	-----	-------	-----	-----



ASP544 LED

Description	Part ID	C1	C2	D × L1	H1	Weight (kg)	C	H
DA3-750 Pole bracket, triple	300-0085	720		76 x 130	950	13.90	720	950

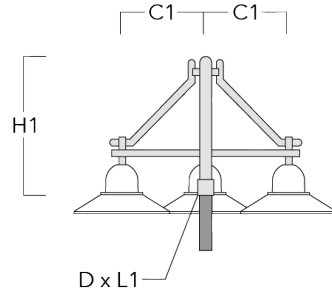

Wall and pole brackets DB

Description	Part ID	C1	C2	D × L1	H1	Weight (kg)	C	H
DB0-750 Wall bracket, single	300-0172	720	70		950	7.10	720	950

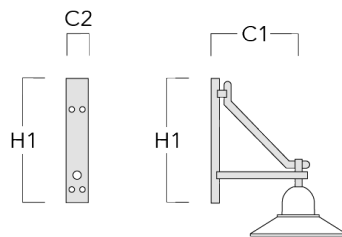

ASP544 LED

Description	Part ID	C1	C2	D x L1	H1	Weight (kg)	C	H
DB1-750 Pole bracket, single	300-0165	720		76 x 130	950	7.10	720	950

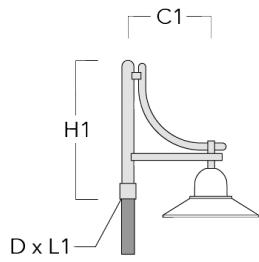

DB2-750 Pole bracket, double	300-0168	720		76 x 130	950	10.20	720	950
------------------------------	----------	-----	--	----------	-----	-------	-----	-----

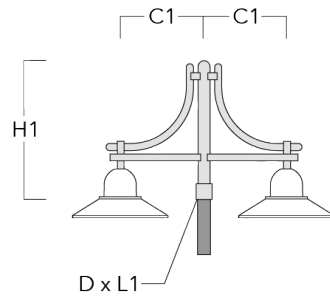

Description	Part ID	C1	C2	D × L1	H1	Weight (kg)	C	H
DB3-750 Pole bracket, triple	300-0170	720		76 x 130	950	13.30	720	950

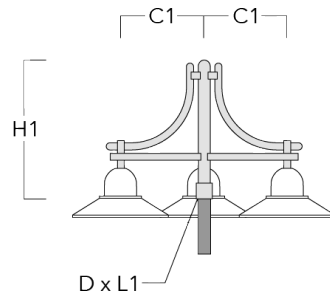

Wall and pole brackets DS

Description	Part ID	C1	C2	D × L1	H1	Weight (kg)	C	H
DS0-750 Wall bracket, single	300-0070	750	70		700	2.60	750	700

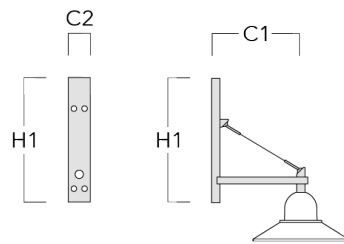

Description	Part ID	C1	C2	D x L1	H1	Weight (kg)	C	H
DS1-750 Pole bracket, single	300-0477	750		76 x 130	850	5.50	750	850

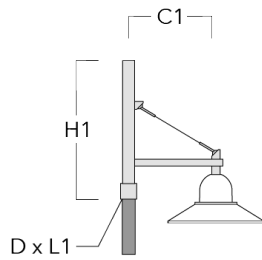

DS2-750 Pole bracket, double	300-0765	750		76 x 130	850	7.20	750	850
------------------------------	----------	-----	--	----------	-----	------	-----	-----

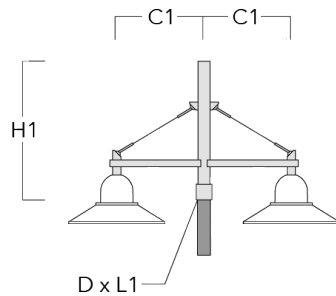

Description	Part ID	C1	C2	D x L1	H1	Weight (kg)	C	H
DS3-750 Pole bracket, triple	300-0766	750		76 x 130	850	8.90	750	850

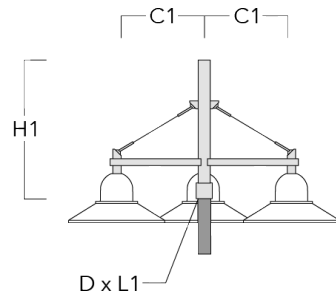

127-1425

ASP544 LED

we-ef

Optical Accessories

Light shield

Description	Part ID	Additional information
LS180	430-0029	Glare Shield for backlight spill. Glare Shield factory-installed or available as retrofit kit. Suitable for [S60], [S65], [S70], [R65], [P65] lenses. Must be specified at time of ordering.

WE-EF LEUCHTEN GmbH

Töpinger Straße 16, 29646 Bispingen, Germany - Phone: +49 5194 909-0
info@we-ef.com - <https://we-ef.com>

Subject to technical changes and errors. - Generated on 23/11/2024