

127-1428

ASP544 LED

we-ef



Description

IP55, Class I. IK10. Marine-grade, die-cast aluminium alloy. 5CE superior corrosion protection including PCS hardware. Silicone rubber gasket. Polycarbonate main lens. Integral EC electronic converter in thermally separated compartment. CAD-optimised optics for superior illumination and glare control. OLC® One LED Concept. Factory installed LED circuit board.

Brackets to be ordered separately.

| | |
|--------------------|-------------------------------|
| Weight | 13.30 kg |
| Light distribution | rectangular, side throw [R65] |
| Light source | LED-36/72W / 700 mA - 2700 K |
| CRI | 80 |
| Power supply | EC |
| LEDs | 36 |
| Rated input power | 79 W |

Nominal Lumen (lm)

| | |
|-------------|------|
| LED Lumen | 270 |
| Total Lumen | 9720 |
| Tj | 85 |

Rated lumens (lm)

| | |
|-------------|--------|
| LED Lumen | 209.4 |
| Total Lumen | 7539.8 |
| Ta | 25 |

WE-EF LIGHTING Pty Ltd

6/13 Downard Street, 3195 Braeside, Victoria - Phone: +61 3 8587 0444 - Fax: +61 3 8587 0499

info.australia@we-ef.com - <https://we-ef.com/aus>

Subject to technical changes and errors. - Generated on 23/11/2024

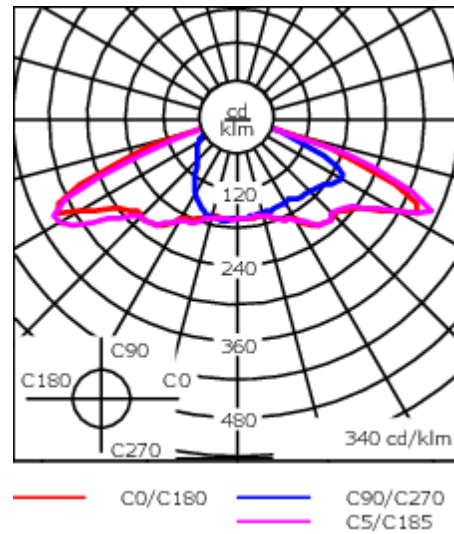
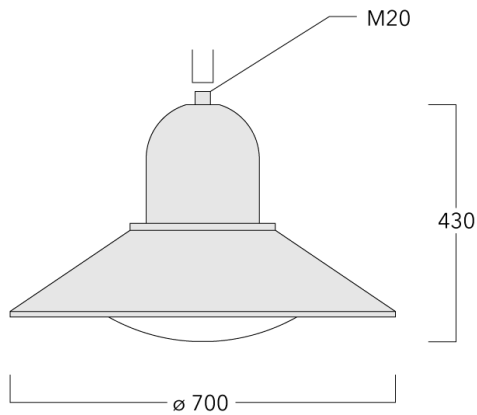

Specifications

Material description

| | |
|----------------------|--|
| Body | Marine-grade, die-cast aluminium alloy |
| Lens | Polycarbonate lens |
| Colours | <div style="display: flex; align-items: center;"> <div style="width: 20px; height: 15px; background-color: black; margin-right: 5px;"></div> RAL9004 Signal black </div> <div style="display: flex; align-items: center; margin-top: 5px;"> <div style="width: 20px; height: 15px; background-color: #cccccc; margin-right: 5px;"></div> RAL9006 White aluminium </div> <div style="display: flex; align-items: center; margin-top: 5px;"> <div style="width: 20px; height: 15px; background-color: #808080; margin-right: 5px;"></div> RAL9007 Grey aluminium </div> |
| Gasket | Silicone rubber gasket |
| Fasteners | PCS Polymer Coated Stainless Steel Hardware |
| Ingress protection | IP55 |
| Impact resistance | IK10 |
| Corrosion resistance | 5CE |
| Windage | 0.1343 m ² |

Electrical description

| | |
|------------------|----------------------------------|
| Power supply | 220-240V / 50-60 Hz |
| Driver / Ballast | Integral EC electronic converter |
| Power factor | > 0.9 |

Additional information

| | |
|----------|------------------------|
| Lifetime | Ta=40° L90B10 > 90000h |
|----------|------------------------|

WE-EF LIGHTING Pty Ltd

6/13 Downard Street, 3195 Braeside, Victoria - Phone: +61 3 8587 0444 - Fax: +61 3 8587 0499

info.australia@we-ef.com - <https://we-ef.com/aus>

Subject to technical changes and errors. - Generated on 23/11/2024

127-1428

ASP544 LED

we-ef

Control

Eco Step Dim® Basic

| Description | Part ID |
|-------------------------|----------|
| Eco Step Dim® Basic LED | 430-0001 |

Eco Step Dim® Advanced

| Description | Part ID |
|----------------------------|----------|
| Eco Step Dim® Advanced LED | 430-0002 |

WE-EF LIGHTING Pty Ltd

6/13 Downard Street, 3195 Braeside, Victoria - Phone: +61 3 8587 0444 - Fax: +61 3 8587 0499

info.australia@we-ef.com - <https://we-ef.com/aus>

Subject to technical changes and errors. - Generated on 23/11/2024

Mounting Accessories

Wall and pole brackets BA

| Description | Part ID | C1 | D x L1 | H1 | H2 | M1 | Weight (kg) | C | H |
|------------------------------|----------|-----|--------|------|-----|----|-------------|-----|------|
| BA0-580 Wall bracket, single | 300-0149 | 635 | | 1000 | 132 | 9 | 2.50 | 635 | 1000 |

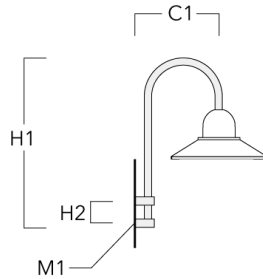

| | | | | | | | | | |
|------------------------------|----------|-----|---------|------|--|--|------|-----|------|
| BA1-580 Pole bracket, single | 300-0089 | 580 | 76 x 80 | 1000 | | | 4.50 | 580 | 1000 |
|------------------------------|----------|-----|---------|------|--|--|------|-----|------|

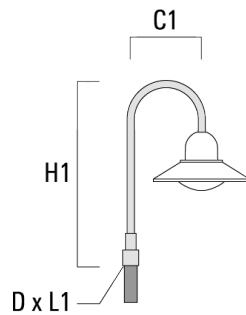

ASP544 LED

| Description | Part ID | C1 | D x L1 | H1 | H2 | M1 | Weight (kg) | C | H |
|------------------------------|----------|-----|---------|------|----|----|-------------|-----|------|
| BA2-580 Pole bracket, double | 300-0090 | 675 | 76 x 80 | 1000 | | | 8.50 | 675 | 1000 |

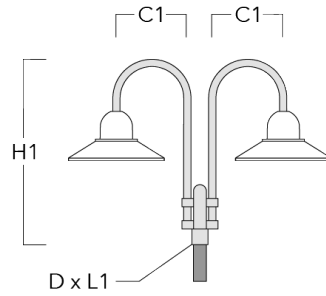

| | | | | | | | | | |
|------------------------------|----------|-----|---------|------|--|--|-------|-----|------|
| BA3-580 Pole bracket, triple | 300-0093 | 675 | 76 x 80 | 1000 | | | 10.50 | 675 | 1000 |
|------------------------------|----------|-----|---------|------|--|--|-------|-----|------|

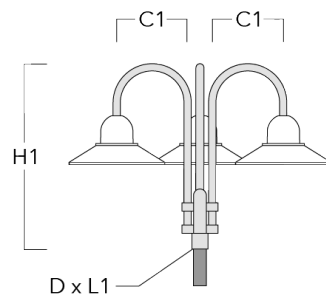

Wall and pole brackets BC

| Description | Part ID | C1 | H1 | H2 | M1 | Weight (kg) | C | H |
|------------------------------|----------|-----|------|-----|----|-------------|-----|------|
| BC0-580 Wall bracket, double | 300-0771 | 635 | 1325 | 300 | 8 | 2.80 | 635 | 1325 |

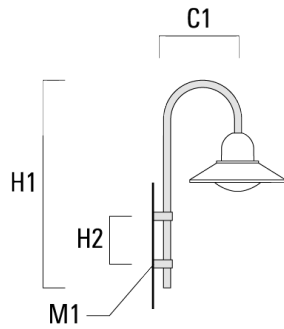

| | | | | | | | | |
|------------------------------|----------|-----|------|-----|---|------|-----|------|
| BC1-580 Pole bracket, single | 300-0770 | 675 | 1325 | 300 | 8 | 2.80 | 675 | 1325 |
|------------------------------|----------|-----|------|-----|---|------|-----|------|

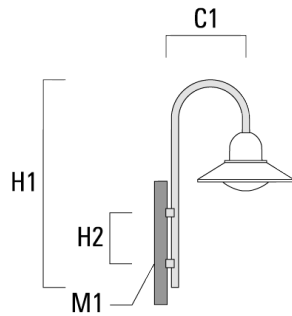

ASP544 LED

| Description | Part ID | C1 | H1 | H2 | M1 | Weight (kg) | C | H |
|------------------------------|----------|-----|------|-----|----|-------------|-----|------|
| BC2-580 Pole bracket, double | 300-0769 | 675 | 1325 | 300 | 8 | 5.60 | 675 | 1325 |

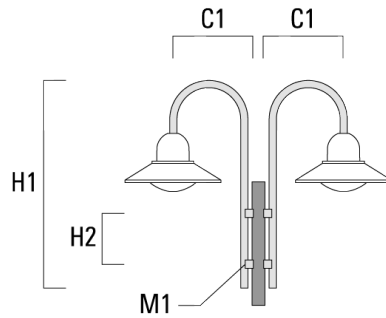

Wall and pole brackets DA

| Description | Part ID | C1 | C2 | D × L1 | H1 | Weight (kg) | C | H |
|------------------------------|----------|-----|----|--------|-----|-------------|-----|-----|
| DA0-750 Wall bracket, single | 300-0086 | 720 | 70 | | 950 | 7.30 | 720 | 950 |

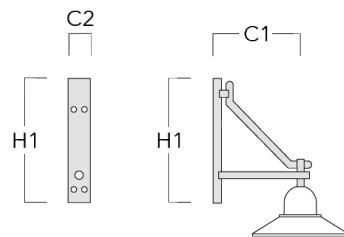

ASP544 LED

| Description | Part ID | C1 | C2 | D x L1 | H1 | Weight (kg) | C | H |
|------------------------------|----------|-----|----|----------|-----|-------------|-----|-----|
| DA1-750 Pole bracket, single | 300-0083 | 720 | | 76 x 130 | 950 | 7.30 | 720 | 950 |

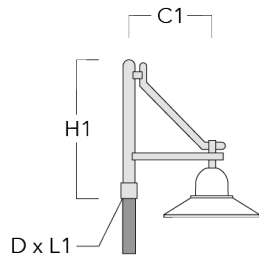

| | | | | | | | | |
|------------------------------|----------|-----|--|----------|-----|-------|-----|-----|
| DA2-750 Pole bracket, double | 300-0084 | 720 | | 76 x 130 | 950 | 10.60 | 720 | 950 |
|------------------------------|----------|-----|--|----------|-----|-------|-----|-----|

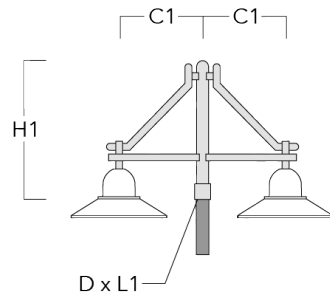

ASP544 LED

| Description | Part ID | C1 | C2 | D × L1 | H1 | Weight (kg) | C | H |
|------------------------------|----------|-----|----|----------|-----|-------------|-----|-----|
| DA3-750 Pole bracket, triple | 300-0085 | 720 | | 76 x 130 | 950 | 13.90 | 720 | 950 |

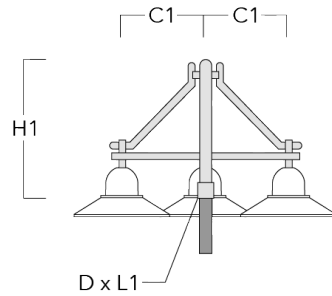

Wall and pole brackets DB

| Description | Part ID | C1 | C2 | D × L1 | H1 | Weight (kg) | C | H |
|------------------------------|----------|-----|----|--------|-----|-------------|-----|-----|
| DB0-750 Wall bracket, single | 300-0172 | 720 | 70 | | 950 | 7.10 | 720 | 950 |

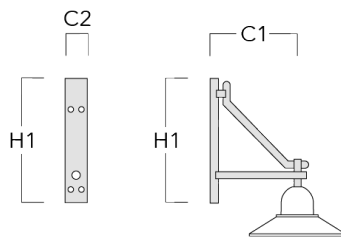

ASP544 LED

| Description | Part ID | C1 | C2 | D x L1 | H1 | Weight (kg) | C | H |
|------------------------------|----------|-----|----|----------|-----|-------------|-----|-----|
| DB1-750 Pole bracket, single | 300-0165 | 720 | | 76 x 130 | 950 | 7.10 | 720 | 950 |

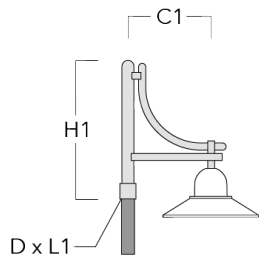

| | | | | | | | | |
|------------------------------|----------|-----|--|----------|-----|-------|-----|-----|
| DB2-750 Pole bracket, double | 300-0168 | 720 | | 76 x 130 | 950 | 10.20 | 720 | 950 |
|------------------------------|----------|-----|--|----------|-----|-------|-----|-----|

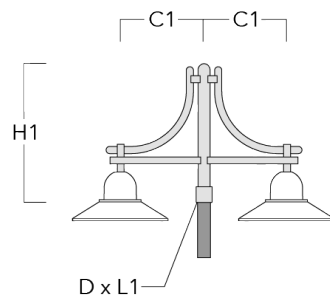

ASP544 LED

| Description | Part ID | C1 | C2 | D × L1 | H1 | Weight (kg) | C | H |
|------------------------------|----------|-----|----|----------|-----|-------------|-----|-----|
| DB3-750 Pole bracket, triple | 300-0170 | 720 | | 76 x 130 | 950 | 13.30 | 720 | 950 |

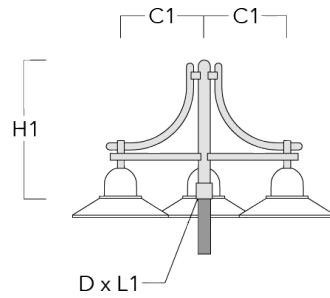

Wall and pole brackets DS

| Description | Part ID | C1 | C2 | D × L1 | H1 | Weight (kg) | C | H |
|------------------------------|----------|-----|----|--------|-----|-------------|-----|-----|
| DS0-750 Wall bracket, single | 300-0070 | 750 | 70 | | 700 | 2.60 | 750 | 700 |

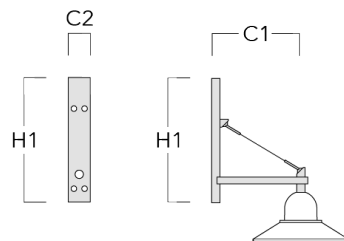

ASP544 LED

| Description | Part ID | C1 | C2 | D x L1 | H1 | Weight (kg) | C | H |
|------------------------------|----------|-----|----|----------|-----|-------------|-----|-----|
| DS1-750 Pole bracket, single | 300-0477 | 750 | | 76 x 130 | 850 | 5.50 | 750 | 850 |

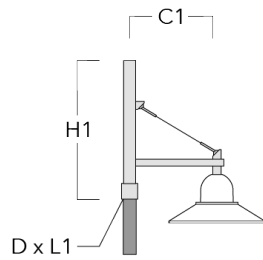

| | | | | | | | | |
|------------------------------|----------|-----|--|----------|-----|------|-----|-----|
| DS2-750 Pole bracket, double | 300-0765 | 750 | | 76 x 130 | 850 | 7.20 | 750 | 850 |
|------------------------------|----------|-----|--|----------|-----|------|-----|-----|

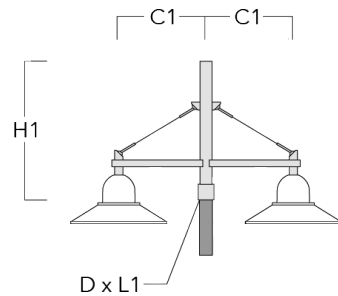

127-1428

ASP544 LED

we-ef

| Description | Part ID | C1 | C2 | D x L1 | H1 | Weight (kg) | C | H |
|------------------------------|----------|-----|----|----------|-----|-------------|-----|-----|
| DS3-750 Pole bracket, triple | 300-0766 | 750 | | 76 x 130 | 850 | 8.90 | 750 | 850 |

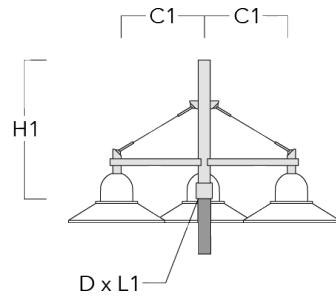

WE-EF LIGHTING Pty Ltd

6/13 Downard Street, 3195 Braeside, Victoria - Phone: +61 3 8587 0444 - Fax: +61 3 8587 0499

info.australia@we-ef.com - <https://we-ef.com/aus>

Subject to technical changes and errors. - Generated on 23/11/2024

127-1428

ASP544 LED

we-ef

Optical Accessories

Light shield

| Description | Part ID | Additional information |
|-------------|----------|--|
| LS180 | 003-4019 | Glare Shield for backlight spill. Glare Shield factory-installed or available as retrofit kit. Suitable for [S60], [S65], [S70], [R65], [P65] lenses. Must be specified at time of ordering. |

WE-EF LIGHTING Pty Ltd

6/13 Downard Street, 3195 Braeside, Victoria - Phone: +61 3 8587 0444 - Fax: +61 3 8587 0499

info.australia@we-ef.com - <https://we-ef.com/aus>

Subject to technical changes and errors. - Generated on 23/11/2024