

127-1432

BSP534 LED

we-ef



Description

IP55. Class I. IK10. Marine-grade, die-cast aluminum alloy. 5CE superior corrosion protection including PCS hardware. Silicone CCG® Controlled Compression Gasket. Polycarbonate main lens. CAD-optimized optics for superior illumination and glare control. Integral driver in thermally separated compartment. OLC® One LED Concept. Factory-installed LED circuit board.

Recommended mounting height 10-13 ft, depending on lamp type selected; brackets to be ordered separately.

Specify product with 7 Digit product code - Finish Color. Accessories, such as mounting, optical, and electrical, must be specified separately.

Example: XXX-XXXX-9004 (Black)
+ XXX-XXXX (Accessory 1)

Weight	13.00 lb
Light distribution	[R65] Type IV Medium
Light source	LED-24/48W / 700 mA - 2700 K
CRI	80
Power supply	electronic gear
LEDs	24
Rated input power	54 W

Nominal Lumen (lm)

LED Lumen	270
Total Lumen	6480
Tj	85

Rated lumens (lm)

LED Lumen	209.4
Total Lumen	5026.5
Ta	25

WE-EF LIGHTING USA, LLC

410-D Keystone Drive, 15086 Warrendale, PA 15086 - Phone: +1 724 742 0030
customersupport.usa@we-ef.com - <https://we-ef.com/us>
Subject to technical changes and errors. - Generated on 11/23/2024

127-1432



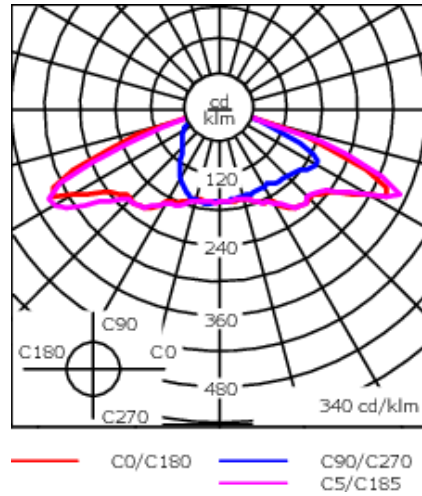
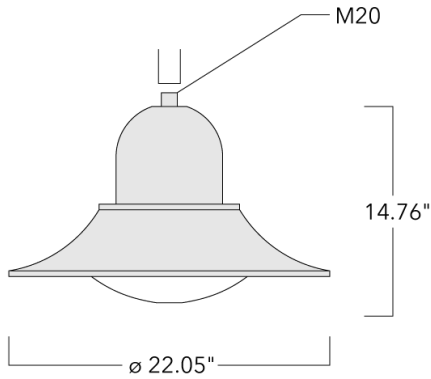

BSP534 LED

we-ef



Specifications

Material description

Body	Marine-grade die-cast aluminium alloy
Lens	Polycarbonate lens
Colors	 RAL9004 Black  RAL9007 Grey Metallic  RAL9016 White  RAL8019 Dark Bronze
Gasket	Silicone rubber gasket
Fasteners	PCS Polymer Coated Stainless Steel hardware
Ingress protection	IP55
Impact resistance	IK10
Corrosion resistance	5CE
Windage	1 ft ²

WE-EF LIGHTING USA, LLC

410-D Keystone Drive, 15086 Warrendale, PA 15086 - Phone: +1 724 742 0030

customersupport.usa@we-ef.com - <https://we-ef.com/us>

Subject to technical changes and errors. - Generated on 11/23/2024

127-1432

BSP534 LED

we-ef

Electrical description

Power supply	Integral [ECG] electronic driver 120V-277V. 0-10V dimmable, to be specified with order.
Driver / Ballast	Integral EC electronic converter
Power factor	> 0.9
Surge protection	Integral 10kV Surge Protector

Additional information

Lifetime	Ta=25°/40° L90B10 > 90000h
BUG Rating	Please see individual Spec Sheets for classification of Backlight, Uplight and Glare.
Listings	ETL, UL-1598, CSA-C22.2#250.0. Suitable for Wet Locations.

WE-EF LIGHTING USA, LLC

410-D Keystone Drive, 15086 Warrendale, PA 15086 - Phone: +1 724 742 0030
customersupport.usa@we-ef.com - <https://we-ef.com/us>
Subject to technical changes and errors. - Generated on 11/23/2024

127-1432

BSP534 LED

we-ef

Mounting Accessories

Wall and pole brackets BA

Description	Part ID	C1	D x L1	H1	H2	L	M1	Weight (lb)	C	H
BA0-420 Wall bracket, single	300-0152	18.11		39.37	5.2		0.35	4.41	460	1000

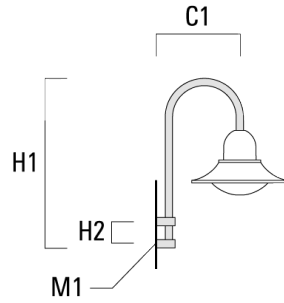

BA1-420 Pole bracket, single	300-0099	16.54	3 x 3	39.37		2.99		8.82	420	1000
------------------------------	----------	-------	-------	-------	--	------	--	------	-----	------

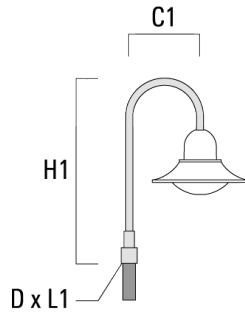

WE-EF LIGHTING USA, LLC

410-D Keystone Drive, 15086 Warrendale, PA 15086 - Phone: +1 724 742 0030
customersupport.usa@we-ef.com - <https://we-ef.com/us>

Subject to technical changes and errors. - Generated on 11/23/2024

BSP534 LED

Description	Part ID	C1	D x L1	H1	H2	L	M1	Weight (lb)	C	H
BA2-420 Pole bracket, double	300-0104	19.69	3 x 3	39.37		2.99		17.64	500	1000

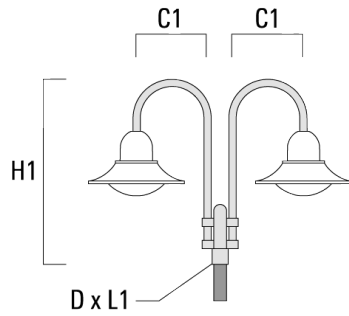

BA3-420 Pole bracket, triple	300-0109	19.69	3 x 3	39.37		2.99		22.05	500	1000
------------------------------	----------	-------	-------	-------	--	------	--	-------	-----	------

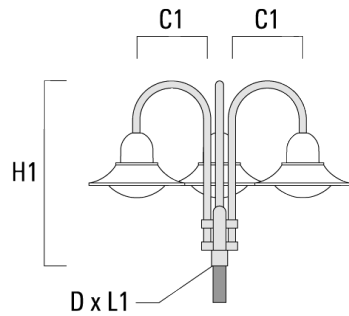

WE-EF LIGHTING USA, LLC

410-D Keystone Drive, 15086 Warrendale, PA 15086 - Phone: +1 724 742 0030

customersupport.usa@we-ef.com - <https://we-ef.com/us>

Subject to technical changes and errors. - Generated on 11/23/2024

Wall and pole brackets BC

Description	Part ID	C1	H1	H2	M1	Weight (lb)	C	H
BC0-420 Wall bracket, single	300-0808	460	1230	11.81	8	2.30	460	1230



BC1-420 Pole bracket, single	300-0768	500	1230	300	8	2.30	500	1230
------------------------------	----------	-----	------	-----	---	------	-----	------



BSP534 LED

Description	Part ID	C1	H1	H2	M1	Weight (lb)	C	H
BC2-420 Pole bracket, double	300-0767	500	1230	300	8	4.60	500	1230

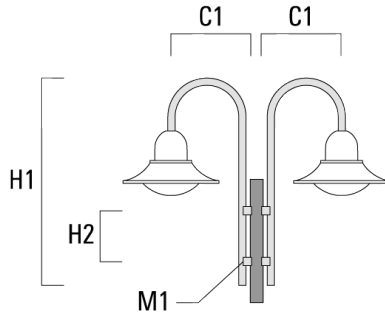

Wall and pole brackets DA

Description	Part ID	C1	C2	D × L1	H1	L	Weight (lb)	C	H
DA0-500 Wall bracket, single	300-0146	20.08	2.76		25.59		12.57	510	650

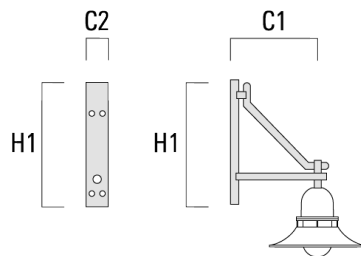

WE-EF LIGHTING USA, LLC

410-D Keystone Drive, 15086 Warrendale, PA 15086 - Phone: +1 724 742 0030

customersupport.usa@we-ef.com - <https://we-ef.com/us>

Subject to technical changes and errors. - Generated on 11/23/2024

127-1432

we-ef

BSP534 LED

Description	Part ID	C1	C2	D x L1	H1	L	Weight (lb)	C	H
DA1-500 Pole bracket, single	300-0138	20.08		3 x 3	27.56	2.99	12.57	510	700

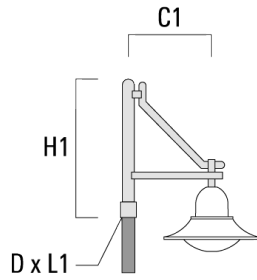

DA2-500 Pole bracket, double	300-0141	20.08		3 x 3	27.56	2.99	18.30	510	700
------------------------------	----------	-------	--	-------	-------	------	-------	-----	-----

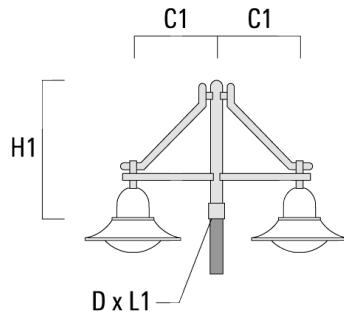

WE-EF LIGHTING USA, LLC

410-D Keystone Drive, 15086 Warrendale, PA 15086 - Phone: +1 724 742 0030
customersupport.usa@we-ef.com - <https://we-ef.com/us>

Subject to technical changes and errors. - Generated on 11/23/2024

BSP534 LED

Description	Part ID	C1	C2	D x L1	H1	L	Weight (lb)	C	H
DA3-500 Pole bracket, triple	300-0144	20.08		3 x 3	27.56	2.99	24.03	510	700

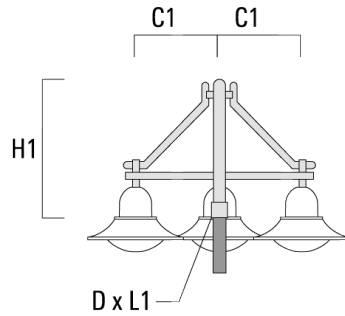

Wall and pole brackets DB

Description	Part ID	C1	C2	D x L1	H1	L	Weight (lb)	C	H
DB0-500 Wall bracket, single	300-0169	20.08	2.76		25.59		12.13	510	650

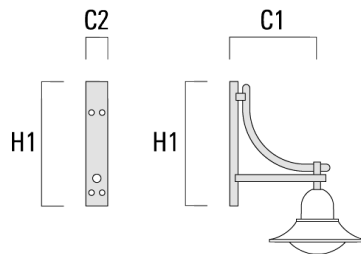

127-1432

we-ef

BSP534 LED

Description	Part ID	C1	C2	D x L1	H1	L	Weight (lb)	C	H
DB1-500 Pole bracket, single	300-0190	20.08		3 x 3	27.56	2.99	12.13	510	700

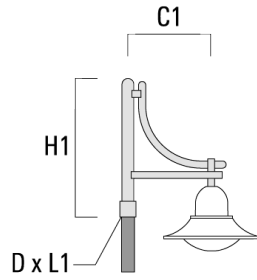

DB2-500 Pole bracket, double	300-0191	20.08		3 x 3	27.56	2.99	17.42	510	700
------------------------------	----------	-------	--	-------	-------	------	-------	-----	-----

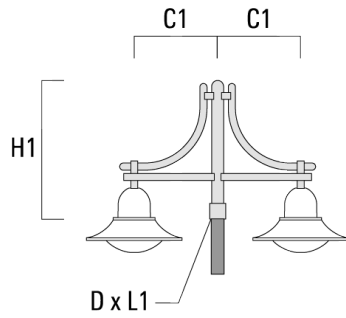

WE-EF LIGHTING USA, LLC

410-D Keystone Drive, 15086 Warrendale, PA 15086 - Phone: +1 724 742 0030
customersupport.usa@we-ef.com - <https://we-ef.com/us>

Subject to technical changes and errors. - Generated on 11/23/2024

BSP534 LED

Description	Part ID	C1	C2	D x L1	H1	L	Weight (lb)	C	H
DB3-500 Pole bracket, triple	300-0192	20.08		3 x 3	27.56	2.99	22.71	510	700

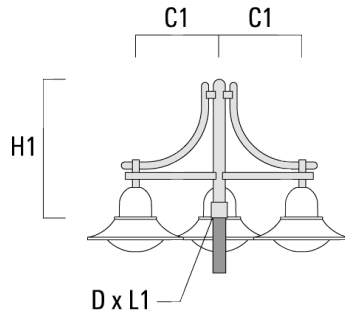

Wall and pole brackets DS

Description	Part ID	C1	C2	D x L1	H1	L	Weight (lb)	C	H
DS0-500 Wall bracket, single	300-0064	20.08	2.76		25.59		5.51	510	650

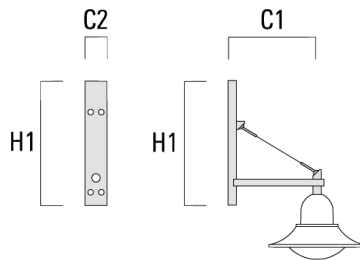

WE-EF LIGHTING USA, LLC

410-D Keystone Drive, 15086 Warrendale, PA 15086 - Phone: +1 724 742 0030

customersupport.usa@we-ef.com - <https://we-ef.com/us>

Subject to technical changes and errors. - Generated on 11/23/2024

BSP534 LED

Description	Part ID	C1	C2	D x L1	H1	L	Weight (lb)	C	H
DS1-500 Pole bracket, single	300-0063	20.08		3 x 3	28.54	2.99	8.60	510	725



DS2-500 Pole bracket, double	300-0066	20.08		3 x 3	28.54	2.99	11.68	510	725
------------------------------	----------	-------	--	-------	-------	------	-------	-----	-----



WE-EF LIGHTING USA, LLC

410-D Keystone Drive, 15086 Warrendale, PA 15086 - Phone: +1 724 742 0030
 customersupport.usa@we-ef.com - <https://we-ef.com/us>

Subject to technical changes and errors. - Generated on 11/23/2024

127-1432

BSP534 LED

we-ef

Description	Part ID	C1	C2	D x L1	H1	L	Weight (lb)	C	H
DS3-500 Pole bracket, triple	300-0069	20.08		3 x 3	28.54	2.99	14.77	510	725

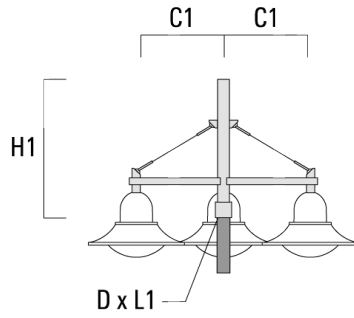

WE-EF LIGHTING USA, LLC

410-D Keystone Drive, 15086 Warrendale, PA 15086 - Phone: +1 724 742 0030
customersupport.usa@we-ef.com - <https://we-ef.com/us>

Subject to technical changes and errors. - Generated on 11/23/2024

127-1432

BSP534 LED

we-ef

Optical Accessories

Light shield

Description	Part ID	Additional information
LS180	430-0029	Glare Shield for backlight spill. Glare Shield factory-installed or available as retrofit kit. Suitable for [S60], [S65], [S70], [R65], [P65] lenses. Must be specified at time of ordering.

WE-EF LIGHTING USA, LLC

410-D Keystone Drive, 15086 Warrendale, PA 15086 - Phone: +1 724 742 0030
customersupport.usa@we-ef.com - <https://we-ef.com/us>

Subject to technical changes and errors. - Generated on 11/23/2024