



### Description

IP55. Classe I. Classe II sur demande. IK10. Corps en fonte d'aluminium. Visserie inox avec traitement PCS. Protection contre la corrosion 5CE. Joint silicone. Modules LED interchangeables avec dissipateur de chaleur. Lentille PMMA avec technologie OLC® pour la maîtrise du flux et la précision de l'éclairage.

Version en 2200K disponible. À préciser lors de la demande de devis.

Poids	5.90 kg
Distribution de la lumière	[R65] Bi-asymétrique - parkings et voiries larges
Source lumineuse	LED-24/48W / 700 mA - 2700 K
IRC	80
Alimentation électrique	ballast électronique
LEDs	24
Rated input power	54 W
<b>Flux lumineux nominal (lm)</b>	
LED Lumen	270
Total Lumen	6480
Tj	85
<b>Rated lumens (lm)</b>	
LED Lumen	209.4
Total Lumen	5026.5
Ta	25

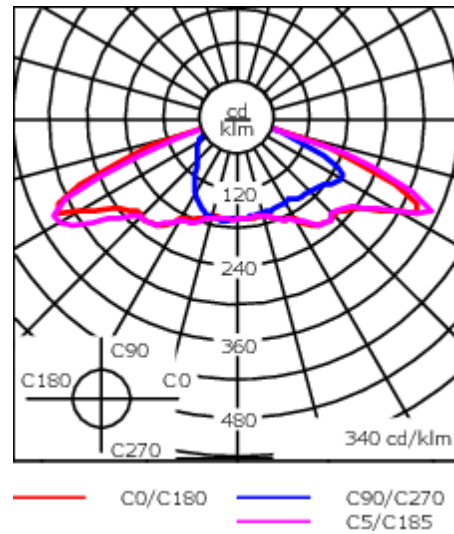
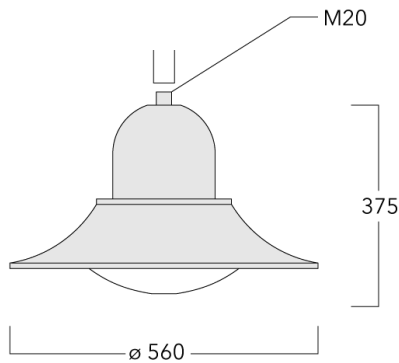
**127-1432****BSP534 LED****we-ef**

## Spécifications

### Description du matériel

Corps	Corps en fonte d'aluminium, visserie inox avec traitement PCS
Lentille	Lentille LED en PMMA, technologie OLC® - Vasque polycarbonate
Couleurs	<div style="display: flex; align-items: center;"> <div style="width: 20px; height: 15px; background-color: black; margin-right: 5px;"></div> <span>RAL9004 Noir de sécurité</span> </div> <div style="display: flex; align-items: center;"> <div style="width: 20px; height: 15px; background-color: gray; margin-right: 5px;"></div> <span>RAL9007 Aluminium gris</span> </div> <div style="display: flex; align-items: center;"> <div style="width: 20px; height: 15px; background-color: darkgray; margin-right: 5px;"></div> <span>RAL7016 Gris anthracite</span> </div> <div style="display: flex; align-items: center;"> <div style="width: 20px; height: 15px; background-color: lightgray; margin-right: 5px;"></div> <span>RAL9016 Blanc signalisation</span> </div>
Joint	Joint silicone
Visserie	PCS Inox avec recouvrement polymère
IP	IP55
IK	IK10
Protection contre la corrosion	5CE
Surface exposée au vent	0.0930m <sup>2</sup>

### Description électrique

Alimentation électrique	220-240V / 50-60 Hz
Driver	Driver électronique. DALI
Power factor	> 0.9

#### WE-EF Switzerland AG

Himmelrichstrasse 6, 6003 Luzern - Téléphone: +41 22 752 49 94

info.switzerland@we-ef.com - [https://we-ef.com/ch\\_fr](https://we-ef.com/ch_fr)

Sous réserve de modifications techniques et d'erreurs. - Généré le 23/10/2024

**127-1432**

**BSP534 LED**

**we-ef**

### **Informations complémentaires**

---

Durée de vie Ta=25° L90B10 > 90000h

Classe d'efficacité  
énergétique C-D

---

**WE-EF Switzerland AG**

Himmelrichstrasse 6, 6003 Luzern - Téléphone: +41 22 752 49 94

info.switzerland@we-ef.com - [https://we-ef.com/ch\\_fr](https://we-ef.com/ch_fr)

Sous réserve de modifications techniques et d'erreurs. - Généré le 23/10/2024

**127-1432**

**BSP534 LED**

**we-ef**

## **Control**

### **Eco Step Dim® Basic**

Description	Référence
Eco Step Dim® Basic LED	430-0001

### **Eco Step Dim® Advanced**

Description	Référence
Eco Step Dim® Advanced LED	430-0002

#### **WE-EF Switzerland AG**

Himmelrichstrasse 6, 6003 Luzern - Téléphone: +41 22 752 49 94

info.switzerland@we-ef.com - [https://we-ef.com/ch\\_fr](https://we-ef.com/ch_fr)

Sous réserve de modifications techniques et d'erreurs. - Généré le 23/10/2024

## Accessoires d'installation

## Crosses murales et Crosses pour mât BA

Description	Référence	C1	D x L1	H1	H2	M1	Poids (kg)	C	H
BA0-420 crosse murale	300-0152	460		1000	132	9	2	460	1000

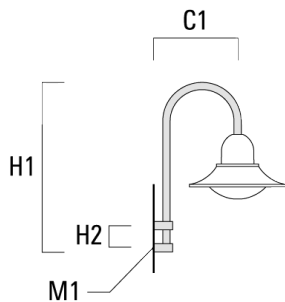

BA1-420 crosse simple	300-0099	420	76 x 80	1000			4	420	1000
-----------------------	----------	-----	---------	------	--	--	---	-----	------

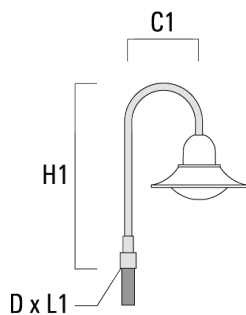

Description	Référence	C1	D x L1	H1	H2	M1	Poids (kg)	C	H
BA2-420 crosse double	300-0104	500	76 x 80	1000			8	500	1000

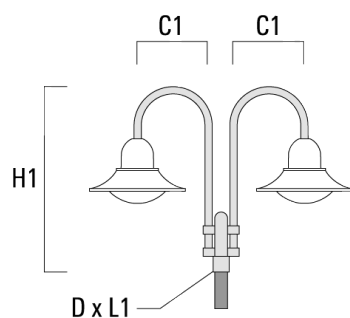

BA3-420 crosse triple	300-0109	500	76 x 80	1000			10	500	1000
-----------------------	----------	-----	---------	------	--	--	----	-----	------

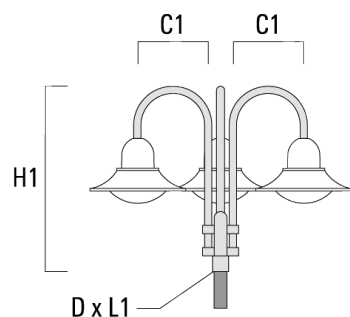

## Crosses murales et Crosses pour mât BC

### WE-EF Switzerland AG

Himmelrichstrasse 6, 6003 Luzern - Téléphone: +41 22 752 49 94

info.switzerland@we-ef.com - [https://we-ef.com/ch\\_fr](https://we-ef.com/ch_fr)

Sous réserve de modifications techniques et d'erreurs. - Généré le 23/10/2024

Description	Référence	C1	H1	H2	M1	Poids (kg)	C	H
BC0-420 crosse murale	300-0808	460	1230	300	8	2.30	460	1230

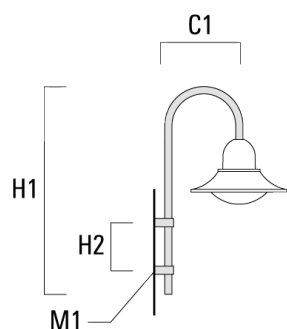

BC1-420 crosse simple	300-0768	500	1230	300	8	2.30	500	1230
-----------------------	----------	-----	------	-----	---	------	-----	------

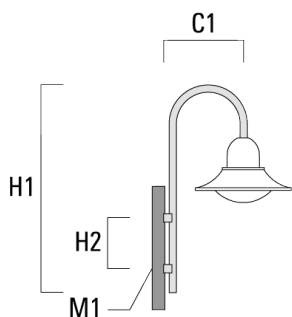

Description	Référence	C1	H1	H2	M1	Poids (kg)	C	H
BC2-420 crosse double	300-0767	500	1230	300	8	4.60	500	1230

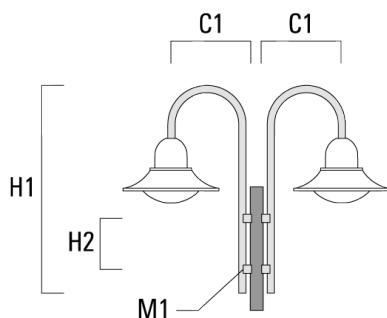

### Crosses murales et Crosses pour mât DA

Description	Référence	C1	C2	D × L1	H1	Poids (kg)	C	H
DA0-500 crosse murale	300-0146	510	70		650	5.70	510	650

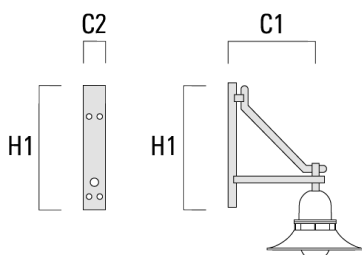



Description	Référence	C1	C2	D x L1	H1	Poids (kg)	C	H
DA1-500 crosse simple	300-0138	510		76 x 80	700	5.70	510	700

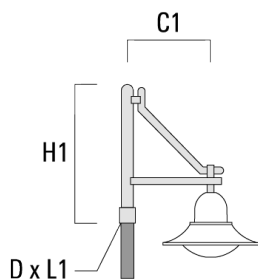

DA2-500 crosse double	300-0141	510		76 x 80	700	8.30	510	700
-----------------------	----------	-----	--	---------	-----	------	-----	-----

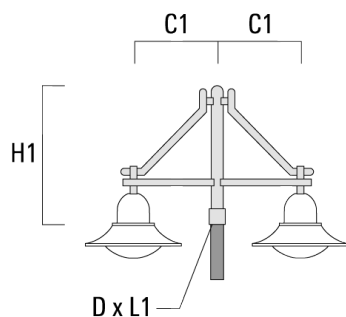

Description	Référence	C1	C2	D × L1	H1	Poids (kg)	C	H
DA3-500 crosse triple	300-0144	510		76 x 80	700	10.90	510	700

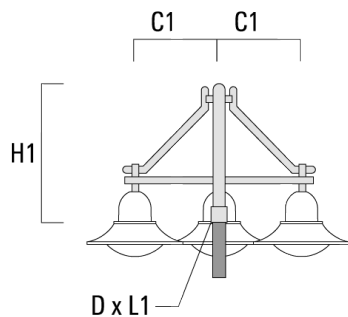

### Crosses murales et Crosses pour mât DB

Description	Référence	C1	C2	D × L1	H1	Poids (kg)	C	H
DB0-500 crosse murale	300-0169	510	70		650	5.50	510	650

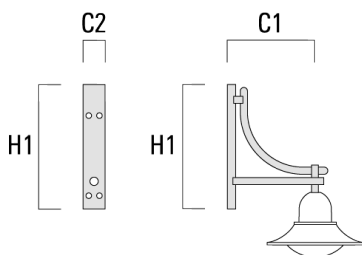

Description	Référence	C1	C2	D x L1	H1	Poids (kg)	C	H
DB1-500 crosse single	300-0190	510		76 x 80	700	5.50	510	700

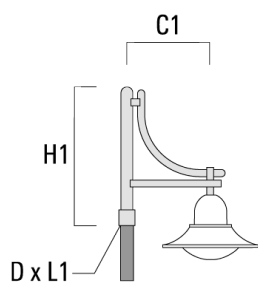

DB2-500 crosse double	300-0191	510		76 x 80	700	7.90	510	700
-----------------------	----------	-----	--	---------	-----	------	-----	-----

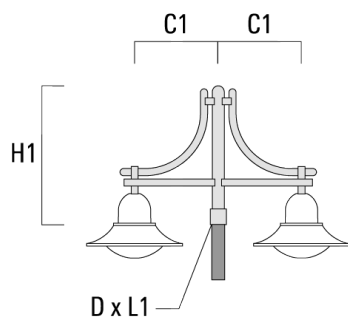

Description	Référence	C1	C2	D × L1	H1	Poids (kg)	C	H
DB3-500 crosse triple	300-0192	510		76 x 80	700	10.30	510	700

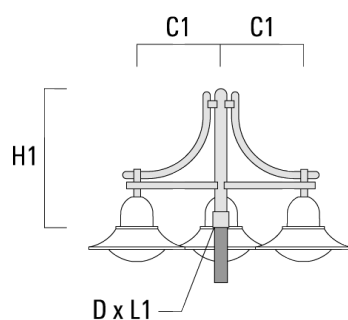

### Crosses murales et Crosses pour mât DS

Description	Référence	C1	C2	D × L1	H1	Poids (kg)	C	H
DS0-500 crosse murale	300-0064	510	70		650	2.50	510	650

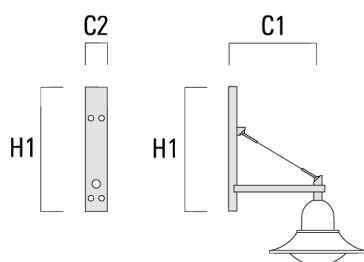

Description	Référence	C1	C2	D x L1	H1	Poids (kg)	C	H
DS1-500 crosse simple	300-0063	510		76 x 80	725	3.90	510	725

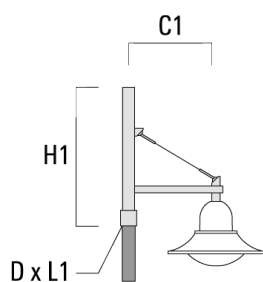

DS2-500 crosse double	300-0066	510		76 x 80	725	5.30	510	725
-----------------------	----------	-----	--	---------	-----	------	-----	-----

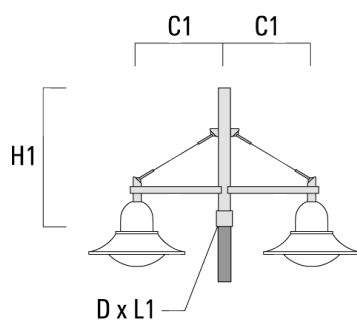

127-1432

BSP534 LED

**we-ef**

Description	Référence	C1	C2	D x L1	H1	Poids (kg)	C	H
DS3-500 crosse triple	300-0069	510		76 x 80	725	6.70	510	725

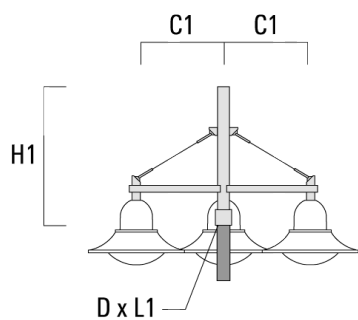

**WE-EF Switzerland AG**

Himmelrichstrasse 6, 6003 Luzern - Téléphone: +41 22 752 49 94

info.switzerland@we-ef.com - [https://we-ef.com/ch\\_fr](https://we-ef.com/ch_fr)

Sous réserve de modifications techniques et d'erreurs. - Généré le 23/10/2024

**127-1432**

**BSP534 LED**

**we-ef**

## Accessoires Optiques

### Light shield

Description	Référence	Informations complémentaires
LS180	430-0029	Coupe-flux arrière adapté pour les optiques [S60], [S65], [S70], [R65], [P65]. Coupe-flux arrière assemblé sur le luminaire en usine ou disponible pour le rétrofit. Cela doit être déterminé à la commande.

**WE-EF Switzerland AG**

Himmelrichstrasse 6, 6003 Luzern - Téléphone: +41 22 752 49 94

info.switzerland@we-ef.com - [https://we-ef.com/ch\\_fr](https://we-ef.com/ch_fr)

Sous réserve de modifications techniques et d'erreurs. - Généré le 23/10/2024

**127-1432**

**BSP534 LED**

**WE-EF Switzerland AG**

Himmelrichstrasse 6, 6003 Luzern

Téléphone: +41 22 752 49 94

[info.switzerland@we-ef.com](mailto:info.switzerland@we-ef.com)

[https://we-ef.com/ch\\_fr](https://we-ef.com/ch_fr)

Sous réserve de modifications techniques et d'erreurs.

Généré le 23/10/2024