

127-1433

BSP544 LED

we-ef



Description

IP55. Class I. IK10. Marine-grade, die-cast aluminum alloy. 5CE superior corrosion protection including PCS hardware. Silicone CCG® Controlled Compression Gasket. Polycarbonate main lens. CAD-optimized optics for superior illumination and glare control. Integral driver in thermally separated compartment. OLC® One LED Concept. Factory-installed LED circuit board. 0-10V Dimming comes standard with luminaire.

Recommended mounting height 10-20 ft, depending on lamp type selected; brackets to be ordered separately.

Specify product with 7 Digit product code - Finish Color. Accessories, such as mounting, optical, and electrical, must be specified separately.

Example: XXX-XXXX-9004 (Black)
+ XXX-XXXX (Accessory 1)

For DarkSky compliant configurations of this product, please find the spec sheet and DarkSky certificate in the library.

Weight	28.90 lb
Light distribution	[S65] Type III Medium
Light source	LED-24/48W / 700 mA - 2700 K
CRI	80
Power supply	electronic gear
LEDs	24
Rated input power	54 W

Nominal Lumen (lm)

LED Lumen	270
Total Lumen	6480
Tj	85

Rated lumens (lm)

LED Lumen	229.7
Total Lumen	5512.6
Ta	25

WE-EF LIGHTING USA, LLC

410-D Keystone Drive, 15086 Warrendale, PA 15086 - Phone: +1 724 742 0030
customersupport.usa@we-ef.com - <https://we-ef.com/us>
Subject to technical changes and errors. - Generated on 11/23/2024

127-1433
BSP544 LED

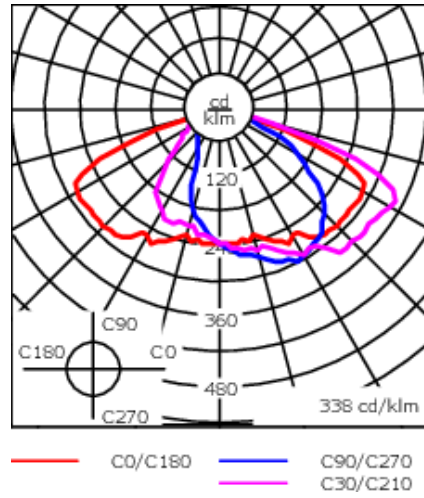
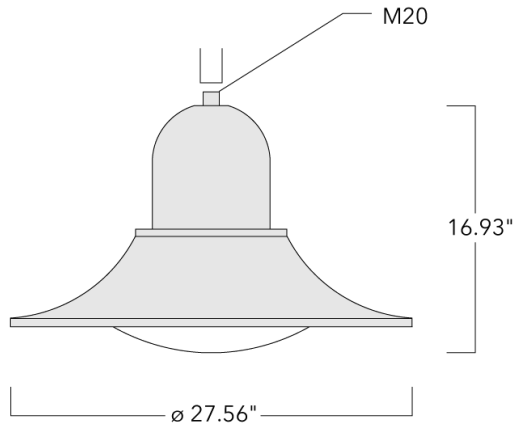

Specifications
Material description

Body	Marine-grade die-cast aluminium alloy
Lens	Polycarbonate lens
Colors	<div style="display: flex; flex-direction: column; gap: 5px;"> <div> RAL9004 Black</div> <div> RAL9007 Grey Metallic</div> <div> RAL9016 White</div> <div> RAL8019 Dark Bronze</div> </div>
Gasket	Silicone rubber gasket
Fasteners	PCS Polymer Coated Stainless Steel hardware
Ingress protection	IP55
Impact resistance	IK10
Corrosion resistance	5CE
Windage	1.34 ft ²

127-1433

BSP544 LED

we-ef

Electrical description

Power supply	Integral [ECG] electronic driver 120V-277V. 0-10V dimmable, to be specified with order.
Driver / Ballast	Integral EC electronic converter
Power factor	> 0.9
Surge protection	Integral 10kV Surge Protector

Additional information

Lifetime	Ta=25°/40° L90B10 > 90000h
BUG Rating	Please see individual Spec Sheets for classification of Backlight, Uplight and Glare.
Listings	ETL, UL-1598, CSA-C22.2#250.0. Suitable for Wet Locations.

WE-EF LIGHTING USA, LLC

410-D Keystone Drive, 15086 Warrendale, PA 15086 - Phone: +1 724 742 0030
customersupport.usa@we-ef.com - <https://we-ef.com/us>
Subject to technical changes and errors. - Generated on 11/23/2024

Mounting Accessories

Wall and pole brackets BA

Description	Part ID	C1	D x L1	H1	H2	L	M1	Weight (lb)	C	H
BA0-580 Wall bracket, single	300-0149	25.00		39.37	5.19		0.35	5.51	635	1000

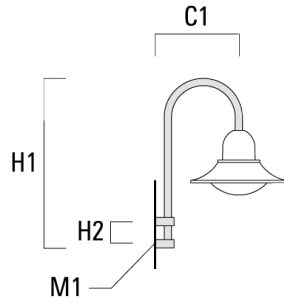

BA1-580 Pole bracket, single	300-0089	22.83	3 x 3	39.37		2.99		9.92	580	1000
------------------------------	----------	-------	-------	-------	--	------	--	------	-----	------

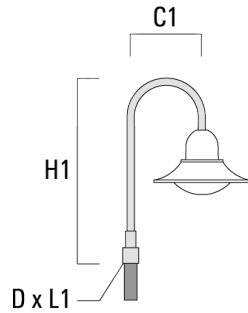

127-1433

we-ef

BSP544 LED

Description	Part ID	C1	D x L1	H1	H2	L	M1	Weight (lb)	C	H
BA2-580 Pole bracket, double	300-0090	26.57	3 x 3	39.37		2.99		18.74	675	1000

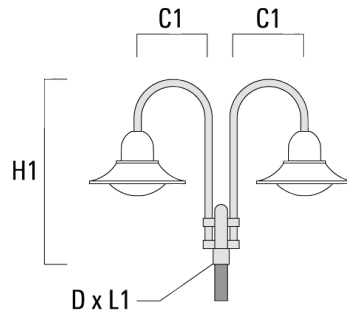

BA3-580 Pole bracket, triple	300-0093	26.57	3 x 3	39.37		2.99		23.15	675	1000
------------------------------	----------	-------	-------	-------	--	------	--	-------	-----	------

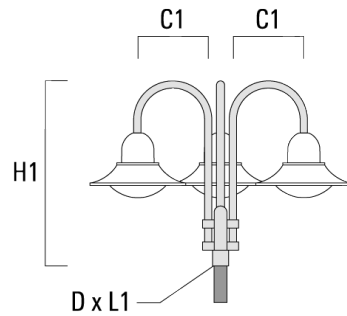

WE-EF LIGHTING USA, LLC

410-D Keystone Drive, 15086 Warrendale, PA 15086 - Phone: +1 724 742 0030
customersupport.usa@we-ef.com - <https://we-ef.com/us>

Subject to technical changes and errors. - Generated on 11/23/2024

Wall and pole brackets BC

Description	Part ID	C1	H1	H2	M1	Weight (lb)	C	H
BC0-580 Wall bracket, double	300-0771	635	1325	11.81	8	2.80	635	1325



BC1-580 Pole bracket, single	300-0770	675	1325	300	8	2.80	675	1325
------------------------------	----------	-----	------	-----	---	------	-----	------



WE-EF LIGHTING USA, LLC

410-D Keystone Drive, 15086 Warrendale, PA 15086 - Phone: +1 724 742 0030

customersupport.usa@we-ef.com - <https://we-ef.com/us>

Subject to technical changes and errors. - Generated on 11/23/2024

BSP544 LED

Description	Part ID	C1	H1	H2	M1	Weight (lb)	C	H
BC2-580 Pole bracket, double	300-0769	675	1325	300	8	5.60	675	1325

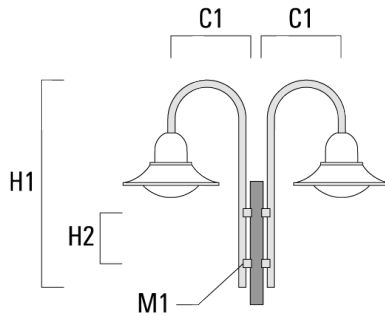

Wall and pole brackets DA

Description	Part ID	C1	C2	D × L1	H1	L	Weight (lb)	C	H
DA0-750 Wall bracket, single	300-0086	28.35	2.76		37.40		16.09	720	950

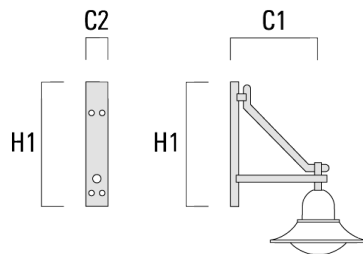

WE-EF LIGHTING USA, LLC

410-D Keystone Drive, 15086 Warrendale, PA 15086 - Phone: +1 724 742 0030

customersupport.usa@we-ef.com - <https://we-ef.com/us>

Subject to technical changes and errors. - Generated on 11/23/2024

127-1433

we-ef

BSP544 LED

Description	Part ID	C1	C2	D x L1	H1	L	Weight (lb)	C	H
DA1-750 Pole bracket, single	300-0083	28.35		3 x 5	37.40	2.99	16.09	720	950

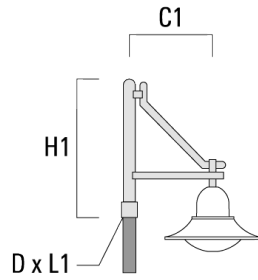

DA2-750 Pole bracket, double	300-0084	28.35		3 x 5	37.40	2.99	23.37	720	950
------------------------------	----------	-------	--	-------	-------	------	-------	-----	-----

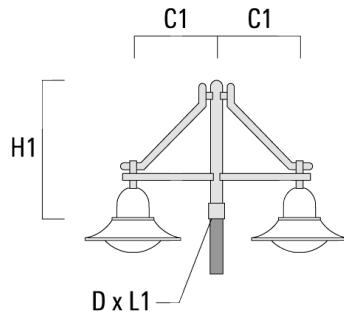

WE-EF LIGHTING USA, LLC

410-D Keystone Drive, 15086 Warrendale, PA 15086 - Phone: +1 724 742 0030
customersupport.usa@we-ef.com - <https://we-ef.com/us>

Subject to technical changes and errors. - Generated on 11/23/2024

BSP544 LED

Description	Part ID	C1	C2	D x L1	H1	L	Weight (lb)	C	H
DA3-750 Pole bracket, triple	300-0085	28.35		3 x 5	37.40	2.99	30.64	720	950

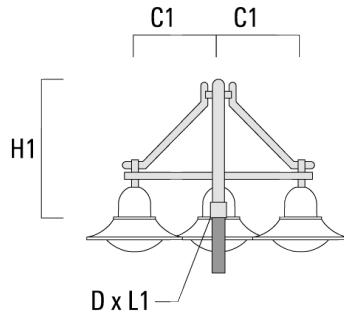

Wall and pole brackets DB

Description	Part ID	C1	C2	D x L1	H1	L	Weight (lb)	C	H
DB0-750 Wall bracket, single	300-0172	28.35	2.76		37.40		15.65	720	950

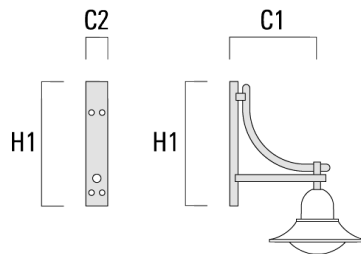

WE-EF LIGHTING USA, LLC

410-D Keystone Drive, 15086 Warrendale, PA 15086 - Phone: +1 724 742 0030
 customersupport.usa@we-ef.com - <https://we-ef.com/us>

Subject to technical changes and errors. - Generated on 11/23/2024

127-1433

we-ef

BSP544 LED

Description	Part ID	C1	C2	D x L1	H1	L	Weight (lb)	C	H
DB1-750 Pole bracket, single	300-0165	28.35		3 x 5	37.40	2.99	15.65	720	950

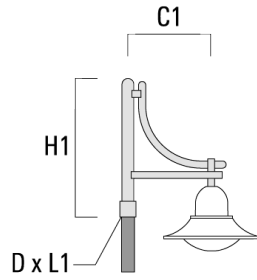

DB2-750 Pole bracket, double	300-0168	28.35		3 x 5	37.40	2.99	22.49	720	950
------------------------------	----------	-------	--	-------	-------	------	-------	-----	-----

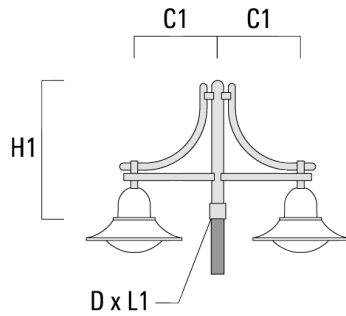

WE-EF LIGHTING USA, LLC

410-D Keystone Drive, 15086 Warrendale, PA 15086 - Phone: +1 724 742 0030
customersupport.usa@we-ef.com - <https://we-ef.com/us>

Subject to technical changes and errors. - Generated on 11/23/2024

BSP544 LED

Description	Part ID	C1	C2	D x L1	H1	L	Weight (lb)	C	H
DB3-750 Pole bracket, triple	300-0170	28.35		3 x 5	37.40	2.99	29.32	720	950

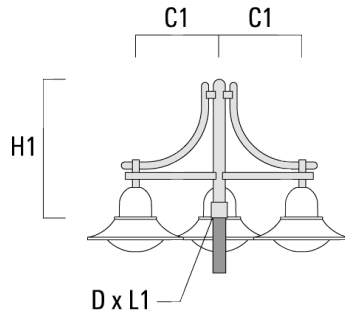

Wall and pole brackets DS

Description	Part ID	C1	C2	D x L1	H1	L	Weight (lb)	C	H
DS0-750 Wall bracket, single	300-0070	29.53	2.76		27.56		5.73	750	700

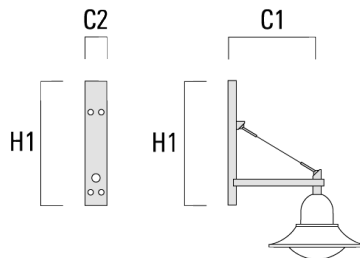

WE-EF LIGHTING USA, LLC

410-D Keystone Drive, 15086 Warrendale, PA 15086 - Phone: +1 724 742 0030

customersupport.usa@we-ef.com - <https://we-ef.com/us>

Subject to technical changes and errors. - Generated on 11/23/2024

127-1433

we-ef

BSP544 LED

Description	Part ID	C1	C2	D x L1	H1	L	Weight (lb)	C	H
DS1-750 Pole bracket, single	300-0477	29.53		3 x 5	33.46	2.99	12.13	750	850



DS2-750 Pole bracket, double	300-0765	29.53		3 x 5	33.46	2.99	15.87	750	850
------------------------------	----------	-------	--	-------	-------	------	-------	-----	-----



WE-EF LIGHTING USA, LLC

410-D Keystone Drive, 15086 Warrendale, PA 15086 - Phone: +1 724 742 0030
customersupport.usa@we-ef.com - <https://we-ef.com/us>

Subject to technical changes and errors. - Generated on 11/23/2024

127-1433

BSP544 LED

we-ef

Description	Part ID	C1	C2	D x L1	H1	L	Weight (lb)	C	H
DS3-750 Pole bracket, triple	300-0766	29.53		3 x 5	33.46	2.99	19.62	750	850

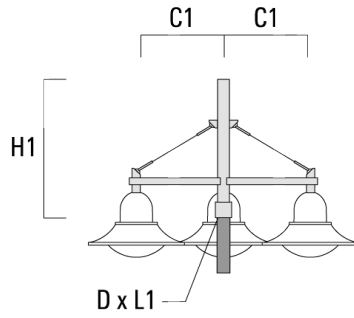

WE-EF LIGHTING USA, LLC

410-D Keystone Drive, 15086 Warrendale, PA 15086 - Phone: +1 724 742 0030
customersupport.usa@we-ef.com - <https://we-ef.com/us>

Subject to technical changes and errors. - Generated on 11/23/2024

127-1433

BSP544 LED

we-ef

Optical Accessories

Light shield

Description	Part ID	Additional information
LS180	430-0029	Glare Shield for backlight spill. Glare Shield factory-installed or available as retrofit kit. Suitable for [S60], [S65], [S70], [R65], [P65] lenses. Must be specified at time of ordering.

WE-EF LIGHTING USA, LLC

410-D Keystone Drive, 15086 Warrendale, PA 15086 - Phone: +1 724 742 0030
customersupport.usa@we-ef.com - <https://we-ef.com/us>

Subject to technical changes and errors. - Generated on 11/23/2024