

127-1434

BSP544 LED

**we-ef**



### Description

IP55, Class I. Cass II on request. IK10. Marine-grade, die-cast aluminium alloy. 5CE superior corrosion protection including PCS hardware. Silicone rubber gasket. Polycarbonate main lens. Integral EC electronic converter in thermally separated compartment. CAD-optimised optics for superior illumination and glare control. OLC® One LED Concept. Factory installed LED circuit board. The luminaire is factory-sealed and does not need to be opened during installation.

Optional 2200 K version available. To be specified at time of ordering.

Brackets to be ordered separately.

Weight	13.10 kg
Light distribution	asymmetric, side throw beam [S65]
Light source	LED-36/72W / 700 mA - 2700 K
CRI	80
Power supply	EC
LEDs	36
Rated input power	79 W

### Nominal Lumen (lm)

LED Lumen	270
Total Lumen	9720
Tj	85

### Rated lumens (lm)

LED Lumen	229.7
Total Lumen	8268.9
Ta	25

### WE-EF LEUCHTEN GmbH

Töpinger Straße 16, 29646 Bispingen, Germany - Phone: +49 5194 909-0  
info@we-ef.com - <https://we-ef.com>

Subject to technical changes and errors. - Generated on 23/11/2024

127-1434



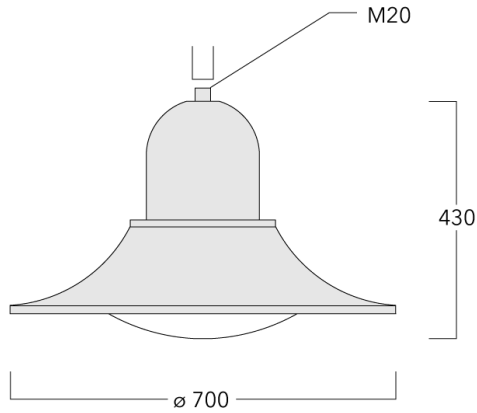

BSP544 LED

**we-ef**



## Specifications

### Material description

Body	Marine-grade, die-cast aluminium alloy
Lens	Polycarbonate lens
Colours	 RAL9004 Signal black  RAL9006 White aluminium  RAL9007 Grey aluminium  RAL7016 Anthracite grey  RAL9016 Traffic white
Gasket	Silicone rubber gasket
Fasteners	PCS Polymer Coated Stainless Steel Hardware
Ingress protection	IP55
Impact resistance	IK10
Corrosion resistance	5CE
Windage	0.1246 m <sup>2</sup>

### Electrical description

Power supply	220-240V / 50-60 Hz
Driver / Ballast	Integral EC electronic converter. DALI
Power factor	> 0.9
Surge protection	6/6 kV (optional SP10)

#### WE-EF LEUCHTEN GmbH

Töpinger Straße 16, 29646 Bispingen, Germany - Phone: +49 5194 909-0  
info@we-ef.com - <https://we-ef.com>

Subject to technical changes and errors. - Generated on 23/11/2024

**127-1434**

**BSP544 LED**

**we-ef**

**Additional information**

---

Lifetime Ta=25° L90B10 > 90000h

Energy efficiency class C-D (Light source)

---

**WE-EF LEUCHTEN GmbH**

Töpinger Straße 16, 29646 Bispingen, Germany - Phone: +49 5194 909-0  
info@we-ef.com - <https://we-ef.com>

Subject to technical changes and errors. - Generated on 23/11/2024

**127-1434**

**BSP544 LED**

**we-ef**

## **Control**

### **Eco Step Dim® Basic**

Description	Part ID
Eco Step Dim® Basic LED	430-0001

### **Eco Step Dim® Advanced**

Description	Part ID
Eco Step Dim® Advanced LED	430-0002

**WE-EF LEUCHTEN GmbH**

Töpinger Straße 16, 29646 Bispingen, Germany - Phone: +49 5194 909-0  
info@we-ef.com - <https://we-ef.com>

Subject to technical changes and errors. - Generated on 23/11/2024

**Mounting Accessories**

**Wall and pole brackets BA**

Description	Part ID	C1	D x L1	H1	H2	M1	Weight (kg)	C	H
BA0-580 Wall bracket, single	300-0149	635		1000	132	9	2.50	635	1000



BA1-580 Pole bracket, single	300-0089	580	76 x 80	1000			4.50	580	1000
------------------------------	----------	-----	---------	------	--	--	------	-----	------



**BSP544 LED**

Description	Part ID	C1	D x L1	H1	H2	M1	Weight (kg)	C	H
BA2-580 Pole bracket, double	300-0090	675	76 x 80	1000			8.50	675	1000

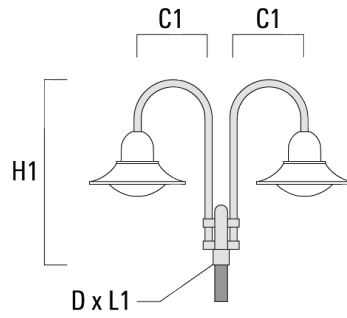

BA3-580 Pole bracket, triple	300-0093	675	76 x 80	1000			10.50	675	1000
------------------------------	----------	-----	---------	------	--	--	-------	-----	------

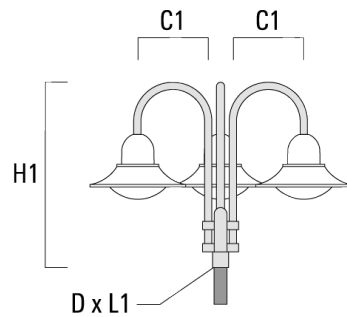

**Wall and pole brackets BC**

Description	Part ID	C1	H1	H2	M1	Weight (kg)	C	H
BC0-580 Wall bracket, double	300-0771	635	1325	300	8	2.80	635	1325



BC1-580 Pole bracket, single	300-0770	675	1325	300	8	2.80	675	1325
------------------------------	----------	-----	------	-----	---	------	-----	------



**BSP544 LED**

Description	Part ID	C1	H1	H2	M1	Weight (kg)	C	H
BC2-580 Pole bracket, double	300-0769	675	1325	300	8	5.60	675	1325



**Wall and pole brackets DA**

Description	Part ID	C1	C2	D × L1	H1	Weight (kg)	C	H
DA0-750 Wall bracket, single	300-0086	720	70		950	7.30	720	950





**BSP544 LED**

Description	Part ID	C1	C2	D x L1	H1	Weight (kg)	C	H
DA1-750 Pole bracket, single	300-0083	720		76 x 130	950	7.30	720	950



DA2-750 Pole bracket, double	300-0084	720		76 x 130	950	10.60	720	950
------------------------------	----------	-----	--	----------	-----	-------	-----	-----



**BSP544 LED**

Description	Part ID	C1	C2	D × L1	H1	Weight (kg)	C	H
DA3-750 Pole bracket, triple	300-0085	720		76 x 130	950	13.90	720	950

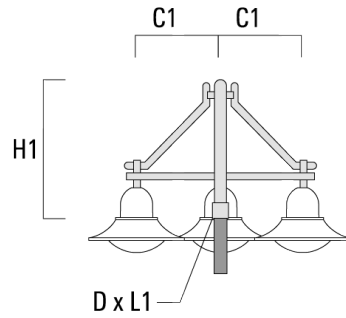

**Wall and pole brackets DB**

Description	Part ID	C1	C2	D × L1	H1	Weight (kg)	C	H
DB0-750 Wall bracket, single	300-0172	720	70		950	7.10	720	950

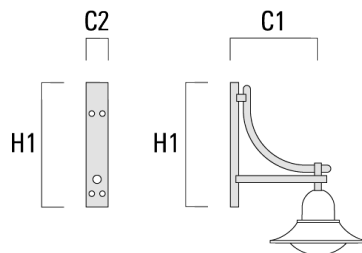

**BSP544 LED**

Description	Part ID	C1	C2	D x L1	H1	Weight (kg)	C	H
DB1-750 Pole bracket, single	300-0165	720		76 x 130	950	7.10	720	950

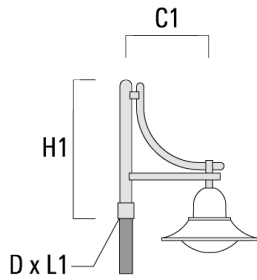

DB2-750 Pole bracket, double	300-0168	720		76 x 130	950	10.20	720	950
------------------------------	----------	-----	--	----------	-----	-------	-----	-----



**BSP544 LED**

Description	Part ID	C1	C2	D × L1	H1	Weight (kg)	C	H
DB3-750 Pole bracket, triple	300-0170	720		76 x 130	950	13.30	720	950

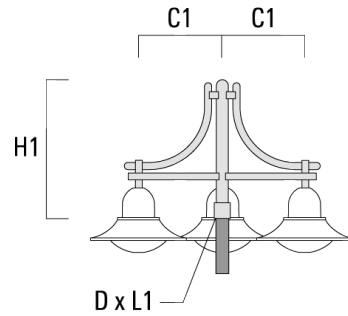

**Wall and pole brackets DS**

Description	Part ID	C1	C2	D × L1	H1	Weight (kg)	C	H
DS0-750 Wall bracket, single	300-0070	750	70		700	2.60	750	700



**BSP544 LED**

Description	Part ID	C1	C2	D x L1	H1	Weight (kg)	C	H
DS1-750 Pole bracket, single	300-0477	750		76 x 130	850	5.50	750	850

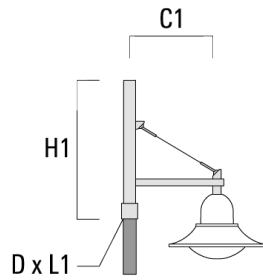

DS2-750 Pole bracket, double	300-0765	750		76 x 130	850	7.20	750	850
------------------------------	----------	-----	--	----------	-----	------	-----	-----

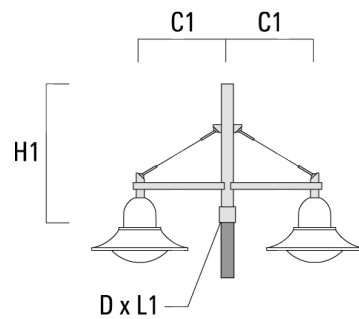

127-1434

BSP544 LED

**we-ef**

Description	Part ID	C1	C2	D x L1	H1	Weight (kg)	C	H
DS3-750 Pole bracket, triple	300-0766	750		76 x 130	850	8.90	750	850

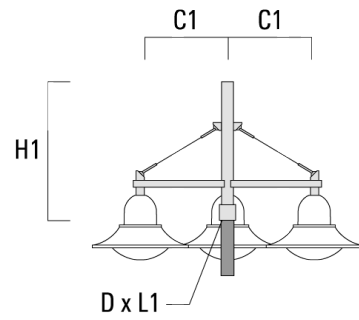

**WE-EF LEUCHTEN GmbH**

Töpinger Straße 16, 29646 Bispingen, Germany - Phone: +49 5194 909-0  
info@we-ef.com - <https://we-ef.com>

Subject to technical changes and errors. - Generated on 23/11/2024

**127-1434**

**BSP544 LED**

**we-ef**

## **Optical Accessories**

### **Light shield**

Description	Part ID	Additional information
LS180	430-0029	Glare Shield for backlight spill. Glare Shield factory-installed or available as retrofit kit. Suitable for [S60], [S65], [S70], [R65], [P65] lenses. Must be specified at time of ordering.