



Beschreibung

IP66, SKI. SKII auf Anfrage. IK08. Korrosionsbeständiger Aluminiumguss. PCS beschichtete Edelstahlschrauben. 5CE Korrosionsschutz. CCG® Silikondichtung. Sicherheitsglas, abklappbar. CAD-optimierte OLC® Technik zur Lichtlenkung und Entblendung.

Variante mit 2200 K bis max. 1050 mA erhältlich, bei Bestellung bitte angeben.

Ausleger sind separat zu bestellen.

| | |
|----------------------------------|---|
| Gewicht | 13.50 kg |
| Lichtverteilung | asymmetrisch vorwärts, breitstrahlend [R65] |
| Lichtquelle | LED-24/48W / 700 mA - 2700 K |
| CRI | 80 |
| Netz | EVG |
| LEDs | 24 |
| Bemessungsleistung | 54 W |
| Nominal Lichtstrom (lm) | |
| LED Lumen | 270 |
| Total Lumen | 6480 |
| Tj | 85 |
| Bemessungslichtstrom (lm) | |
| LED Lumen | 197.1 |
| Total Lumen | 4730.5 |
| Ta | 25 |

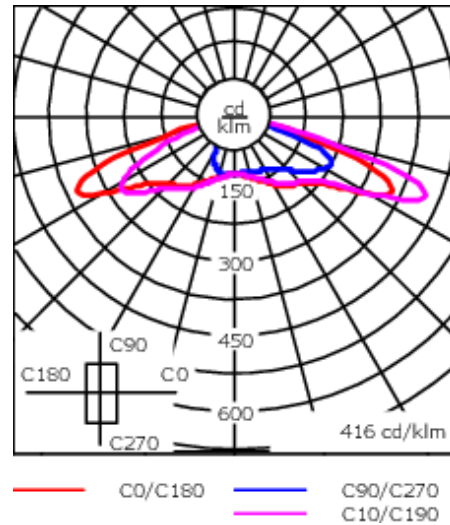
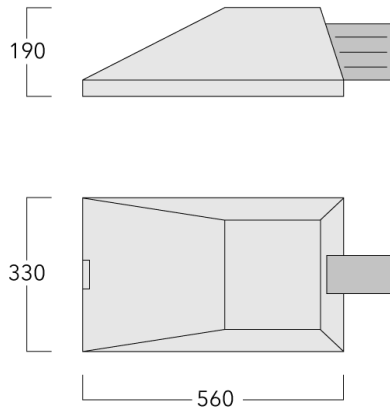

Spezifikationen

Materialbeschreibung

| | |
|-------------------------|--|
| Gehäuse | Korrosionsbeständiger Aluminiumguss |
| Abdeckung | Sicherheitsglas, abklappbar |
| Farben | <div style="display: flex; align-items: center; gap: 10px;"> <div style="width: 20px; height: 15px; background-color: black; margin-bottom: 5px;"></div> RAL9004 Signalschwarz </div> <div style="display: flex; align-items: center; gap: 10px; margin-bottom: 5px;"> <div style="width: 20px; height: 15px; background-color: gray; margin-bottom: 5px;"></div> RAL9007 Graualuminium </div> <div style="display: flex; align-items: center; gap: 10px; margin-bottom: 5px;"> <div style="width: 20px; height: 15px; background-color: darkgray; margin-bottom: 5px;"></div> RAL7016 Anthrazitgrau </div> <div style="display: flex; align-items: center; gap: 10px;"> <div style="width: 20px; height: 15px; background-color: lightgray; margin-bottom: 5px;"></div> RAL9016 Verkehrsweiß </div> |
| Dichtung | CCG® Silikondichtung |
| Schrauben | PCS beschichtete Edelstahlschrauben |
| Schutzart | IP66 |
| Schlagfestigkeit | IK08 |
| Korrosionsbeständigkeit | 5CE |
| Windangriffsfläche | 0.075 m ² |

Elektrische Beschreibung

| | |
|-------------------------------|---|
| Netz | 220-240V / 50-60 Hz |
| Netzgerät / Vorschaltgerät | Eingebaute elektronische Betriebsgeräte. DALI |
| Leistungsfaktor | > 0.9 |

Weitere Informationen

Lebensdauer Ta=25° L90B10 > 90000h

Energieeffizienzklasse C-D (Lichtquelle)

Steuerung**Eco Step Dim® Basic**

| Beschreibung | Artikelnummer |
|-------------------------|---------------|
| Eco Step Dim® Basic LED | 430-0001 |

Eco Step Dim® Advanced

| Beschreibung | Artikelnummer |
|----------------------------|---------------|
| Eco Step Dim® Advanced LED | 430-0002 |

Montagezubehör

Wand- und Mastausleger KI

| Beschreibung | Artikelnummer | A | C1 | D1 | D2 | H1 | M1 | Gewicht (kg) | Alpha | C | D | H |
|--------------------------|---------------|------|-----|-----|-----|----|----|--------------|-------|-----|-----|-----|
| KI0-240/260 Wandausleger | 108-0493 | ±30° | 210 | 180 | 140 | | 12 | 5.70 | ±3° | 210 | 180 | 180 |

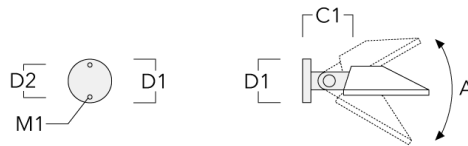

| | | | | | | | | | | | | |
|-------------------------------|----------|------|-----|--|--|-----|--|------|-------------|-----|--|-----|
| KI1-240 Mastausleger, einfach | 108-0491 | ±30° | 210 | | | 525 | | 6.90 | +15° / -30° | 210 | | 525 |
|-------------------------------|----------|------|-----|--|--|-----|--|------|-------------|-----|--|-----|

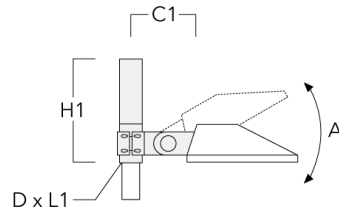

| Beschreibung | Artikelnummer | A | C1 | D1 | D2 | H1 | M1 | Gewicht (kg) | Alpha | C | D | H |
|--------------------------------|---------------|------|-----|----|----|-----|----|--------------|-------------|-----|---|-----|
| KI2-240 Mastausleger, zweifach | 108-0492 | ±30° | 210 | | | 525 | | 8.60 | +15° / -30° | 210 | | 525 |

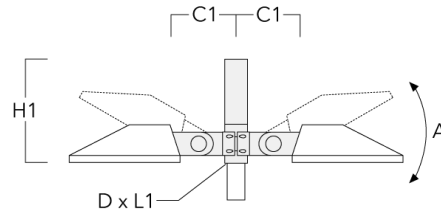

Mastausleger KL

| Beschreibung | Artikelnummer | C1 | D x L1 | H1 | Gewicht (kg) | C | H |
|-------------------------------|---------------|-----|----------|-----|--------------|-----|-----|
| KL1-240 Mastausleger, einfach | 108-0342 | 735 | 76 x 130 | 750 | 9 | 725 | 750 |

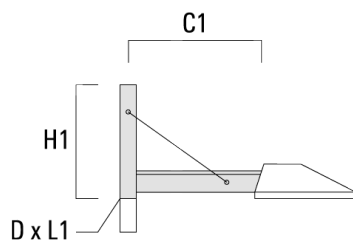

| Beschreibung | Artikelnummer | C1 | D × L1 | H1 | Gewicht (kg) | C | H |
|--------------------------------|---------------|-----|----------|-----|--------------|-----|-----|
| KL2-240 Mastausleger, zweifach | 108-0532 | 735 | 76 x 130 | 750 | 14 | 725 | 750 |

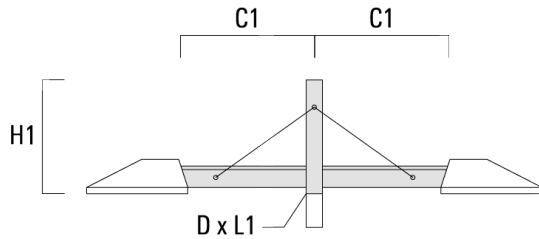

Wand- und Mastausleger KP

| Beschreibung | Artikelnummer | C1 | D1 | D2 | D × L1 | H1 | M1 | Gewicht (kg) | C | D | H |
|----------------------|---------------|-----|-----|-----|--------|----|------|--------------|-----|-----|-----|
| KP0-240 Wandausleger | 108-0103 | 200 | 230 | 195 | | | 12 2 | | 175 | 230 | 230 |

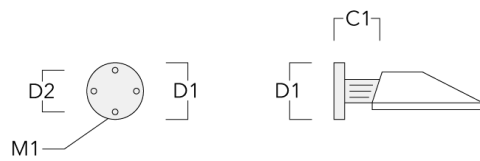

PFL240 LED

| Beschreibung | Artikelnummer | C1 | D1 | D2 | D x L1 | H1 | M1 | Gewicht (kg) | C | D | H |
|-------------------------------|---------------|-----|----|----|---------|-----|----|--------------|-----|---|-----|
| KP1-240 Mastausleger, einfach | 108-0104 | 215 | | | 76 x 80 | 575 | | 3.80 | 175 | | 575 |

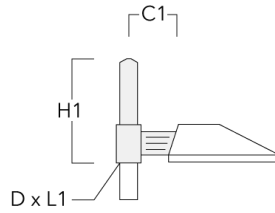

| | | | | | | | | | | | |
|--------------------------------|----------|-----|--|--|---------|-----|--|------|-----|--|-----|
| KP2-240 Mastausleger, zweifach | 108-0105 | 215 | | | 76 x 80 | 575 | | 3.80 | 175 | | 575 |
|--------------------------------|----------|-----|--|--|---------|-----|--|------|-----|--|-----|

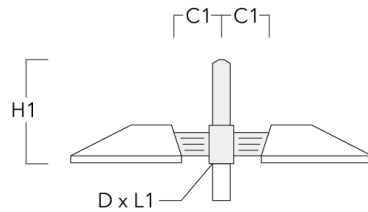

Mastausleger KP_L

| Beschreibung | Artikelnummer | C1 | D x L1 | H1 | Gewicht (kg) | C | H |
|---------------------------------|---------------|-----|----------|-----|--------------|-----|-----|
| KP1-L-240 Mastausleger, einfach | 108-0268 | 635 | 76 x 130 | 575 | 9.10 | 175 | 575 |

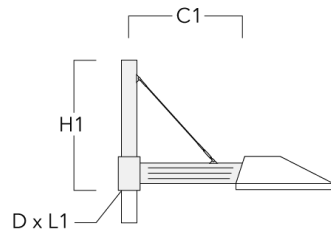

| | | | | | | | |
|----------------------------------|----------|-----|----------|-----|----|-----|-----|
| KP2-L-240 Mastausleger, zweifach | 108-0373 | 635 | 76 x 130 | 575 | 15 | 175 | 575 |
|----------------------------------|----------|-----|----------|-----|----|-----|-----|

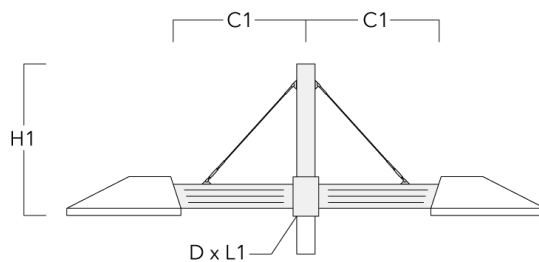

Mastausleger KX

| Beschreibung | Artikelnummer | C1 | D x L1 | H1 | Gewicht (kg) | C | H |
|-------------------------------|---------------|-----|----------|-----|--------------|-----|-----|
| KX1-240 Mastausleger, einfach | 108-0343 | 735 | 76 x 130 | 410 | 7 | 725 | 410 |

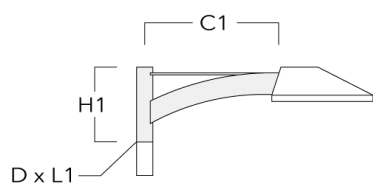

| | | | | | | | |
|--------------------------------|----------|-----|----------|-----|----|-----|-----|
| KX2-240 Mastausleger, zweifach | 108-0534 | 735 | 76 x 130 | 410 | 11 | 725 | 410 |
|--------------------------------|----------|-----|----------|-----|----|-----|-----|

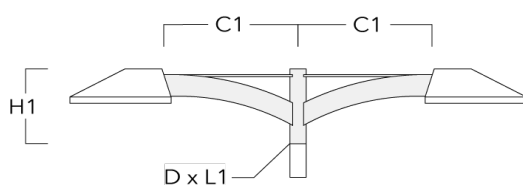

Mastausleger KY

| Beschreibung | Artikelnummer | A | C1 | D × L1 | H1 | Gewicht (kg) | Alpha | C | H |
|-------------------------------|---------------|------|-----|---------|-----|--------------|-------------|-----|-----|
| KY1-240 Mastausleger, einfach | 108-0500 | ±30° | 210 | 76 x 80 | 930 | 9.90 | +15° / -30° | 210 | 575 |

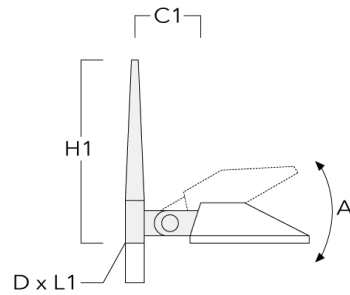

| | | | | | | | | | |
|--------------------------------|----------|------|-----|---------|-----|-------|-------------|-----|-----|
| KY2-240 Mastausleger, zweifach | 108-0501 | ±30° | 210 | 76 x 80 | 730 | 12.80 | +15° / -30° | 210 | 575 |
|--------------------------------|----------|------|-----|---------|-----|-------|-------------|-----|-----|

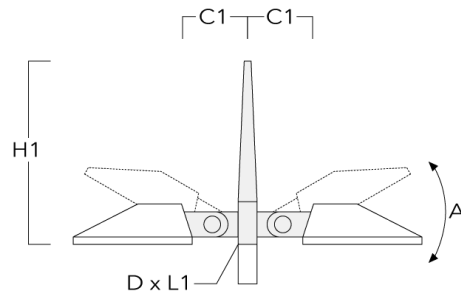

Mastschellen SI

| Beschreibung | Artikelnummer | C1 | D1 | Gewicht (kg) | C |
|--|---------------|-----|-------|--------------|-----|
| SI1-240/260 Mastschelle, einfach (Ø 76-89) | 108-0482 | 210 | 76-89 | 3.60 | 210 |

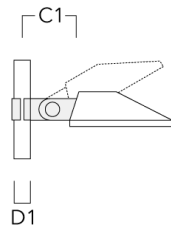

| | | | | | |
|--|----------|-----|---------|------|-----|
| SI1-240/260 Mastschelle, einfach (Ø 114-133) | 108-0483 | 210 | 114-133 | 4.40 | 210 |
|--|----------|-----|---------|------|-----|

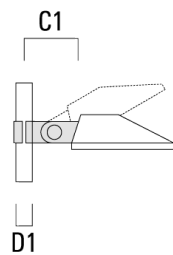

PFL240 LED

| Beschreibung | Artikelnummer | C1 | D1 | Gewicht (kg) | C |
|--|---------------|-----|---------|--------------|-----|
| SI1-240/260 Mastschelle, einfach (Ø 102-114) | 108-0781 | 210 | 102-114 | 4 | 210 |

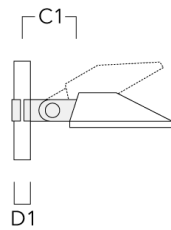

| | | | | | |
|---|----------|-----|-------|------|-----|
| SI2-240/260 Mastschelle, zweifach (Ø 76-89) | 108-0484 | 210 | 76-89 | 5.20 | 210 |
|---|----------|-----|-------|------|-----|

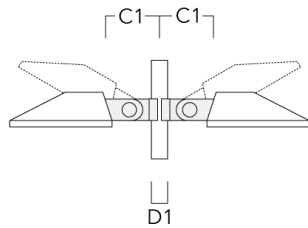

PFL240 LED

| Beschreibung | Artikelnummer | C1 | D1 | Gewicht (kg) | C |
|---|---------------|-----|---------|--------------|-----|
| SI2-240/260 Mastschelle, zweifach (Ø 114-133) | 108-0485 | 210 | 114-133 | 6.20 | 210 |

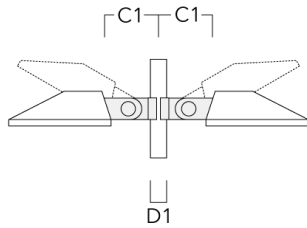

| | | | | | |
|---|----------|-----|---------|------|-----|
| SI2-240/260 Mastschelle, zweifach (Ø 102-114) | 108-0783 | 210 | 102-114 | 5.70 | 210 |
|---|----------|-----|---------|------|-----|

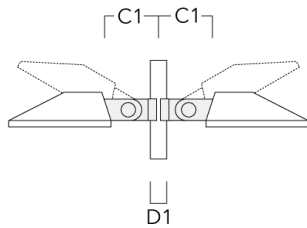

Mastschellen SK

| Beschreibung | Artikelnummer | C1 | D1 | Gewicht (kg) | C |
|--|---------------|-----|---------|--------------|-----|
| SK1-240 Mastschelle, einfach (Ø 102-114) | 108-0782 | 175 | 102-114 | 3.40 | 175 |

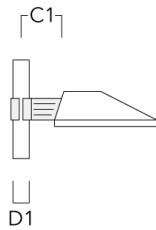

| | | | | | |
|--|----------|-----|-------|---|-----|
| SK1-240 Mastschelle, einfach (Ø 76-89) | 108-0788 | 175 | 76-89 | 3 | 175 |
|--|----------|-----|-------|---|-----|

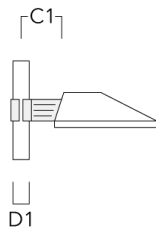

PFL240 LED

| Beschreibung | Artikelnummer | C1 | D1 | Gewicht (kg) | C |
|--|---------------|-----|---------|--------------|-----|
| SK1-240 Mastschelle, einfach (Ø 114-133) | 108-0789 | 175 | 114-133 | 3.80 | 175 |

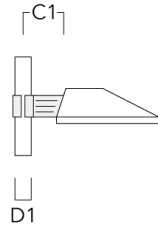

| | | | | | |
|---|----------|-----|---------|------|-----|
| SK2-240 Mastschelle, zweifach (Ø 102-114) | 108-0784 | 175 | 102-114 | 4.30 | 175 |
|---|----------|-----|---------|------|-----|

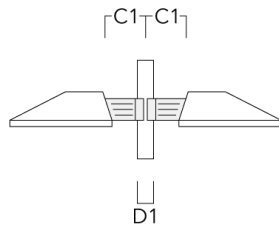

PFL240 LED

| Beschreibung | Artikelnummer | C1 | D1 | Gewicht (kg) | C |
|---|---------------|-----|-------|--------------|-----|
| SK2-240 Mastschelle, zweifach (Ø 76-89) | 108-0790 | 175 | 76-89 | 3.90 | 175 |

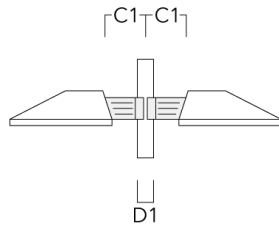

| | | | | | |
|---|----------|-----|---------|------|-----|
| SK2-240 Mastschelle, zweifach (Ø 114-133) | 108-0791 | 175 | 114-133 | 4.70 | 175 |
|---|----------|-----|---------|------|-----|

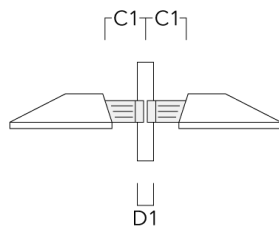

Optisches Zubehör

Blendschutz

| Beschreibung | Artikelnummer | Weitere Informationen |
|--------------|---------------|--|
| LS180-[A60] | 430-0038 | Blende LS180 zur Reduktion des rückseitigen Streulichts oder Beseitigung von Lichtimmissionen. PA Spritzguss-Komponente, matt schwarz. Geeignet für asymmetrische Lichtverteilung [A60]. |
| LS180 | 430-0029 | Blendschutz zur Reduktion des rückseitigen Streulichts. Blendschutz werkseitig eingebaut oder als Nachrüstsatz erhältlich. Geeignet für asymmetrische Lichtverteilung [S60],[S65],[S70],[R65],[P65], bei Bestellung bitte angeben. |