

115-1529

ZFT440-FT LED

we-ef



Description

IP66, Class I. Class II on request. IK09. Marine-grade, die-cast aluminium alloy. 5CE superior corrosion protection including PCS hardware. Silicone CCG® Controlled Compression Gasket. PMMA main lens. Integral EC electronic converter in thermally separated compartment. CAD-optimised indirect optics for superior illumination and glare control. Factory installed LED circuit board. The luminaire is factory-sealed and does not need to be opened during installation.

Weight	5.50 kg
Light distribution	symmetric distribution [C60]
Light source	LED-FT-24W / 700 mA - 2700 K
CRI	80
Power supply	EC
LEDs	1
Rated input power	27 W

Rated lumens (lm)

LED Lumen	2573.2
Total Lumen	2573.2
Ta	25

Nominal Lumen (lm)

LED Lumen	4050
Total Lumen	4050
Tc	25

WE-EF LEUCHTEN GmbH

Töpinger Straße 16, 29646 Bispingen, Germany - Phone: +49 5194 909-0
info@we-ef.com - <https://we-ef.com>

Subject to technical changes and errors. - Generated on 23/11/2024

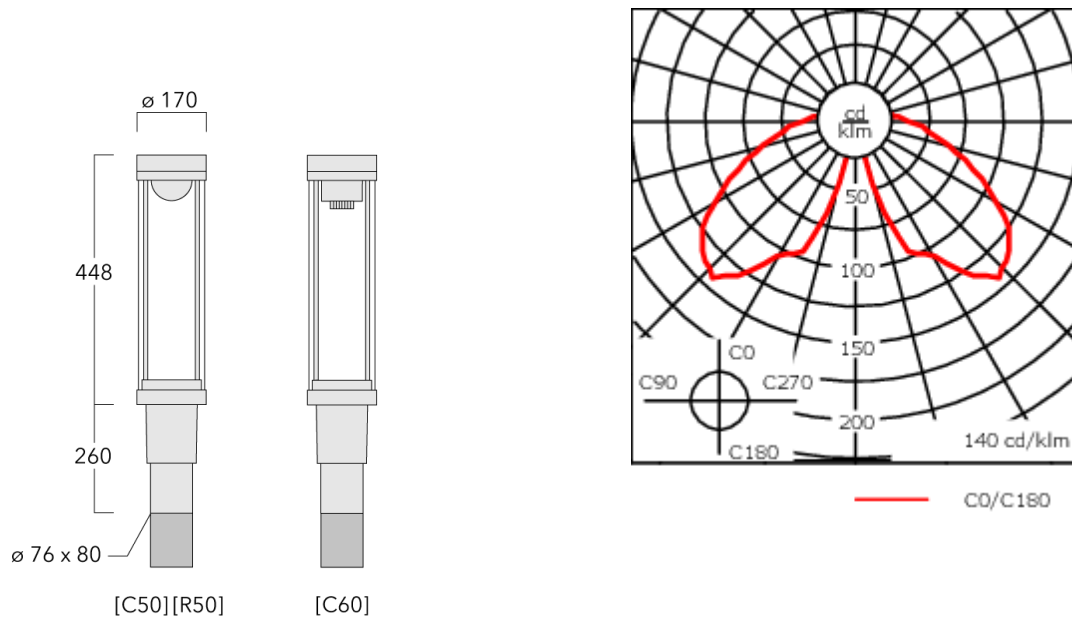

Specifications

Material description

Body	Marine-grade, die-cast aluminium alloy
Lens	PMMA
Colours	<div style="display: flex; align-items: center;"> <div style="width: 20px; height: 15px; background-color: black; margin-right: 5px;"></div> RAL9004 Signal black </div> <div style="display: flex; align-items: center; margin-top: 5px;"> <div style="width: 20px; height: 15px; background-color: #cccccc; margin-right: 5px;"></div> RAL9006 White aluminium </div> <div style="display: flex; align-items: center; margin-top: 5px;"> <div style="width: 20px; height: 15px; background-color: #808080; margin-right: 5px;"></div> RAL9007 Grey aluminium </div> <div style="display: flex; align-items: center; margin-top: 5px;"> <div style="width: 20px; height: 15px; background-color: #333333; margin-right: 5px;"></div> RAL7016 Anthracite grey </div> <div style="display: flex; align-items: center; margin-top: 5px;"> <div style="width: 20px; height: 15px; background-color: #e0e0e0; margin-right: 5px;"></div> RAL9016 Traffic white </div>
Gasket	Silicone CCG® Controlled Compression Gasket
Fasteners	PCS Polymer Coated Stainless Steel Hardware
Ingress protection	IP66
Impact resistance	IK09
Corrosion resistance	5CE
Windage	0.133 m ²

Electrical description

Power supply	220-240V / 50-60 Hz
Driver / Ballast	Integral EC electronic converter in thermally-separated compartment
Power factor	> 0.9
Surge protection	6/6 kV (optional SP10)

WE-EF LEUCHTEN GmbH

Töpinger Straße 16, 29646 Bispingen, Germany - Phone: +49 5194 909-0
 info@we-ef.com - <https://we-ef.com>

Subject to technical changes and errors. - Generated on 23/11/2024

115-1529

ZFT440-FT LED

we-ef

Additional information

Lifetime Ta=25° L70B50 > 50000h

Energy efficiency class C-D (Light source)

WE-EF LEUCHTEN GmbH

Töpinger Straße 16, 29646 Bispingen, Germany - Phone: +49 5194 909-0
info@we-ef.com - <https://we-ef.com>

Subject to technical changes and errors. - Generated on 23/11/2024

115-1529

ZFT440-FT LED

we-ef

Control

Eco Step Dim® Basic

Description	Part ID
Eco Step Dim® Basic LED	430-0001

Eco Step Dim® Advanced

Description	Part ID
Eco Step Dim® Advanced LED	430-0002

WE-EF LEUCHTEN GmbH

Töpinger Straße 16, 29646 Bispingen, Germany - Phone: +49 5194 909-0
info@we-ef.com - <https://we-ef.com>

Subject to technical changes and errors. - Generated on 23/11/2024

Mounting Accessories

Wall and pole brackets RZ

Description	Part ID	C1	D1	D2	D x L1	M1	Weight (kg)
RZ0-400 Wall bracket, single	115-1324	277	231	195	76 x 80	12	3.50



RZ2-400 Pole bracket, double	115-1323	258			76 x 100		4.90
------------------------------	----------	-----	--	--	----------	--	------



115-1529

ZFT440-FT LED

we-ef

Optical Accessories

Light shield

Description	Part ID	H1
LS180-[C60]	159-0321	120

