

115-1599

ZFT430 LED

we-ef



Description

IP66. Class I. IK09. Marine-grade, die-cast aluminum alloy. 5CE superior corrosion protection including PCS hardware. Silicone CCG® Controlled Compression Gasket. PMMA main lens. CAD-optimized optics for superior illumination and glare control. Integral driver in thermally separated compartment. OLC® One LED Concept. Factory-installed LED circuit board. 0-10V Dimming comes standard with luminaire. Luminaire is factory-sealed and does not need to be opened during installation.

Recommended mounting height 10-20 ft.

Specify product with 7 Digit product code - Finish Color. Accessories, such as mounting, optical, and electrical, must be specified separately.

Example: XXX-XXXX-9004 (Black)
+ XXX-XXXX (Accessory 1)

Weight	12.00 lb
Light distribution	[S65] Type III Medium
Light source	LED-9/9W / 350 mA - 2700 K
CRI	80
Power supply	electronic gear
BUG	B0 U1 G1
LEDs	9
Rated input power	11 W

Nominal Lumen (lm)

LED Lumen	145
Total Lumen	1305
Tj	85

Rated lumens (lm)

LED Lumen	118.4
Total Lumen	1065.6
Ta	25

WE-EF LIGHTING USA, LLC

410-D Keystone Drive, 15086 Warrendale, PA 15086 - Phone: +1 724 742 0030
customersupport.usa@we-ef.com - <https://we-ef.com/us>
Subject to technical changes and errors. - Generated on 11/23/2024

115-1599
ZFT430 LED

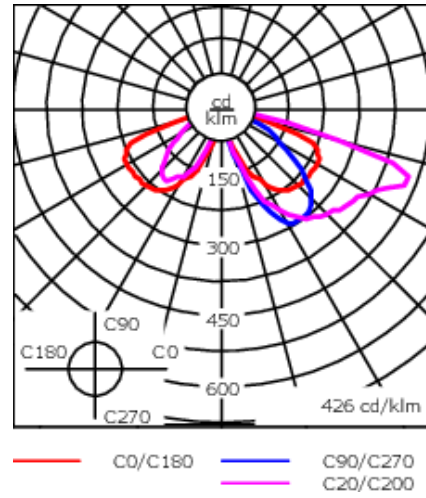
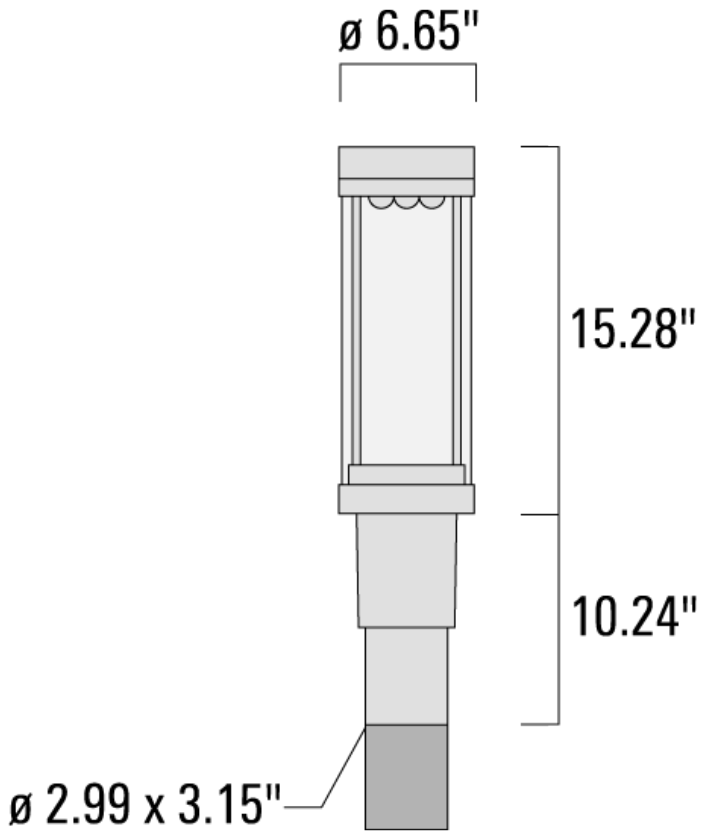

WE-EF LIGHTING USA, LLC

410-D Keystone Drive, 15086 Warrendale, PA 15086 - Phone: +1 724 742 0030
customersupport.usa@we-ef.com - <https://we-ef.com/us>
Subject to technical changes and errors. - Generated on 11/23/2024





115-1599

we-ef

ZFT430 LED

Specifications

Material description

Body	Marine-grade die-cast aluminium alloy
Lens	Clear polycarbonate lens.
Colors	 RAL9004 Black  RAL9007 Grey Metallic  RAL9016 White  RAL8019 Dark Bronze
Gasket	Silicone rubber gasket
Fasteners	PCS Polymer Coated Stainless Steel hardware
Ingress protection	IP66
Impact resistance	IK09
Corrosion resistance	5CE
Windage	0.104 m ²

Electrical description

Power supply	Integral [ECG] electronic driver 120V-277V. 0-10V dimmable, to be specified with order.
Driver / Ballast	Integral EC electronic converter
Power factor	> 0.9
Surge protection	In-line bracket 10kV Surge Protector

Additional information

Lifetime	Ta=25°/40° L90B10 > 90000h
Listings	ETL, UL-1598, CSA-C22.2#250.0. Suitable for Wet Locations.

WE-EF LIGHTING USA, LLC

410-D Keystone Drive, 15086 Warrendale, PA 15086 - Phone: +1 724 742 0030

customersupport.usa@we-ef.com - <https://we-ef.com/us>

Subject to technical changes and errors. - Generated on 11/23/2024

Mounting Accessories

Wall and pole brackets RZ

Description	Part ID	C1	D1	D2	D x L1	M1	Weight (lb)
RZ0-400 Wall bracket, single	115-1324	10.90"	9.1"	7.67"	3" x 3"	0.47"	7.72 lbs

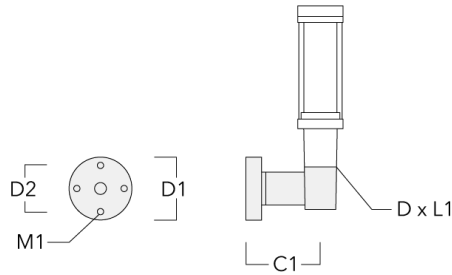

RZ2-400 Pole bracket, double	115-1323	10.16"			3" x 3"		10.8 lbs
------------------------------	----------	--------	--	--	---------	--	----------

