

115-1608

ZFT440 LED

**we-ef**



**Description**

IP66. Post top luminaire with shielded light source and canopy highlight feature.

Weight	13.00 lb
Light distribution	[R65] Type IV Medium
Light source	LED-9/18W / 700 mA - 2700 K
CRI	80
Power supply	electronic gear
LEDs	9
Rated input power	20 W
<b>Nominal Lumen (lm)</b>	
LED Lumen	270
Total Lumen	2430
Tj	85
<b>Rated lumens (lm)</b>	
LED Lumen	234
Total Lumen	2106
Ta	25

**WE-EF LIGHTING USA, LLC**

410-D Keystone Drive, 15086 Warrendale, PA 15086 - Phone: +1 724 742 0030

customersupport.usa@we-ef.com - <https://we-ef.com/us>

Subject to technical changes and errors. - Generated on 10/23/2024

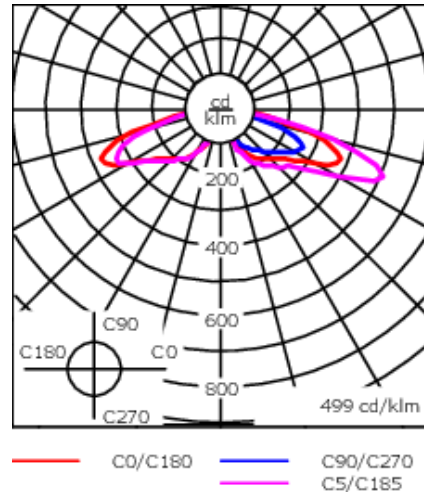
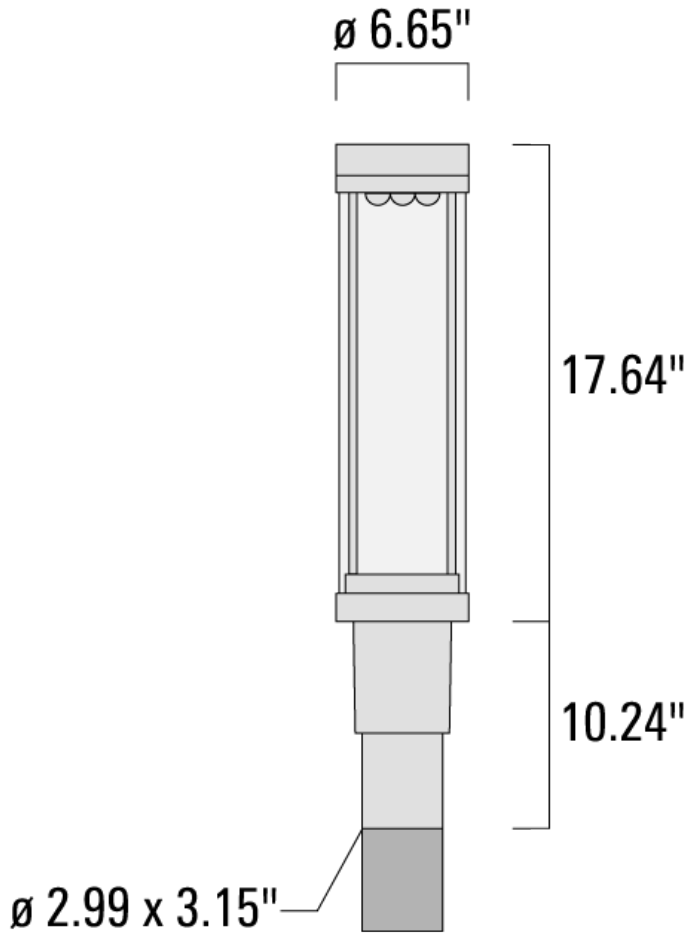

## Specifications

### WE-EF LIGHTING USA, LLC

410-D Keystone Drive, 15086 Warrendale, PA 15086 - Phone: +1 724 742 0030

customersupport.usa@we-ef.com - <https://we-ef.com/us>

Subject to technical changes and errors. - Generated on 10/23/2024





**115-1608**

**ZFT440 LED**

**we-ef**

### Material description

---

Body	Marine-grade die-cast aluminium alloy
Lens	Clear polycarbonate lens
Colors	 RAL9004 Black  RAL9007 Grey Metallic  RAL9016 White  RAL8019 Dark Bronze
Gasket	Silicone rubber gasket
Fasteners	PCS Polymer Coated Stainless Steel hardware
Ingress protection	IP66
Impact resistance	IK09
Corrosion resistance	5CE
Windage	0.133 m <sup>2</sup>

---

### Electrical description

---

Power supply	Integral [ECG] LED driver in 120 or 277 volt.
Driver / Ballast	Integral EC electronic converter
Power factor	> 0.9

---

### Additional information

---

Lifetime	Ta=25°/40° L90B10 > 90000h
Listings	Contact WE-EF USA for ETL/UL certification status.

---

**WE-EF LIGHTING USA, LLC**

410-D Keystone Drive, 15086 Warrendale, PA 15086 - Phone: +1 724 742 0030

customersupport.usa@we-ef.com - <https://we-ef.com/us>

Subject to technical changes and errors. - Generated on 10/23/2024

**Mounting Accessories**

**Wall and pole brackets RZ**

Description	Part ID	C1	D1	D2	D x L1	M1	Weight (lb)
RZ0-400 Wall bracket, single	115-1324	10.90"	9.1"	7.67"	3" x 3"	0.47"	7.72 lbs

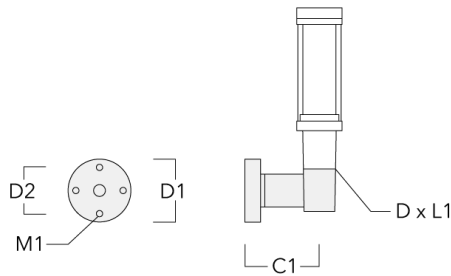

RZ2-400 Pole bracket, double	115-1323	10.16"			3" x 3"		10.8 lbs
------------------------------	----------	--------	--	--	---------	--	----------

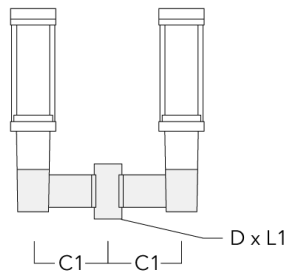

**115-1608**

**ZFT440 LED**

**WE-EF LIGHTING USA, LLC**

410-D Keystone Drive, 15086 Warrendale, PA 15086

Phone: +1 724 742 0030

[customersupport.usa@we-ef.com](mailto:customersupport.usa@we-ef.com)

<https://we-ef.com/us>

Subject to technical changes and errors.

Generated on 10/23/2024

**we-ef**

---

A Fagerhult Group Company