

111-0422

RFL540-SE LED

we-ef



Description

Wall and pole mounted LED luminaire.

IP66. Class I. IK07. Marine-grade, die-cast aluminum alloy. 5CE superior corrosion protection including PCS hardware. Silicone CCG® Controlled Compression Gasket. Non-reflecting safety glass lens hinged, tool-less entry. CAD-optimized optics for superior illumination and glare control. Integral driver in thermally separated compartment. OLC® One LED Concept. Factory-installed LED circuit board. 0-10V Dimming comes standard with luminaire. Luminaire is factory-sealed and does not need to be opened during installation.

Recommended mounting height 10-30 ft, depending on wattage and light distribution selected.

Specify product with 7 Digit product code - Finish Color. Accessories, such as mounting, optical, and electrical, must be specified separately.

Example: XXX-XXXX-9004 (Black)
+ XXX-XXXX (Accessory 1)

For DarkSky compliant configurations of this product,

Weight	33.00 lb
Light distribution	[S65] Type III Medium
Light source	LED-36/36W / 350 mA - 4000 K
CRI	80
Power supply	electronic gear
BUG	B1 U0 G1
LEDs	36
Rated input power	39 W
Nominal Lumen (lm)	
LED Lumen	170
Total Lumen	6120
Tj	85
Rated lumens (lm)	
LED Lumen	157.8
Total Lumen	5679.2
Ta	25

WE-EF LIGHTING USA, LLC

410-D Keystone Drive, 15086 Warrendale, PA 15086 - Phone: +1 724 742 0030
customersupport.usa@we-ef.com - <https://we-ef.com/us>
Subject to technical changes and errors. - Generated on 11/23/2024

111-0422

RFL540-SE LED

we-ef

please find the spec sheet and DarkSky certificate in the library.

WE-EF LIGHTING USA, LLC

410-D Keystone Drive, 15086 Warrendale, PA 15086 - Phone: +1 724 742 0030
customersupport.usa@we-ef.com - <https://we-ef.com/us>

Subject to technical changes and errors. - Generated on 11/23/2024

111-0422

we-ef

RFL540-SE LED

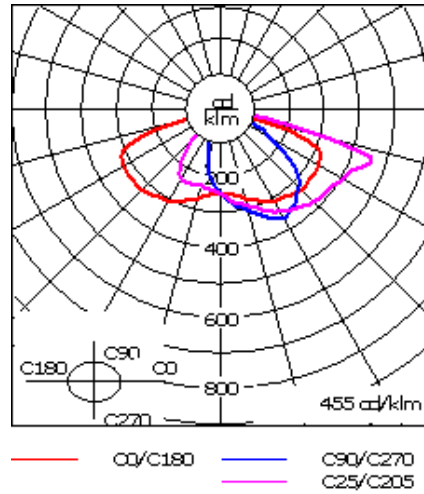
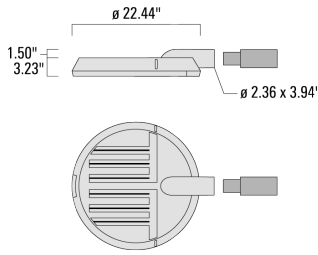

Specifications

Material description

Body	Marine-grade die-cast aluminium alloy
Lens	Non-reflecting safety glass lens, hinged
Colors	<div style="display: flex; flex-direction: column; gap: 5px;"> <div> RAL9004 Black</div> <div> RAL9007 Grey Metallic</div> <div> RAL9016 White</div> <div> RAL8019 Dark Bronze</div> </div>
Gasket	Silicone rubber gasket
Fasteners	PCS Polymer Coated Stainless Steel hardware
Ingress protection	IP66
Impact resistance	IK07
Corrosion resistance	5CE
Windage	0.5 ft ²

Electrical description

Power supply	Integral [ECG] electronic driver 120V-277V. 0-10V dimmable, to be specified with order.
Driver / Ballast	Integral EC electronic converter
Power factor	> 0.9
Surge protection	In-line bracket 10kV Surge Protector

WE-EF LIGHTING USA, LLC

410-D Keystone Drive, 15086 Warrendale, PA 15086 - Phone: +1 724 742 0030

customersupport.usa@we-ef.com - <https://we-ef.com/us>

Subject to technical changes and errors. - Generated on 11/23/2024

111-0422

we-ef

RFL540-SE LED

Additional information

Lifetime	Ta=25°/40° L90B10 > 90000h
BUG Rating	Please see individual Spec Sheets for classification of Backlight, Uplight and Glare.
Listings	ETL, UL-1598, CSA-C22.2#250.0. Suitable for Wet Locations.

WE-EF LIGHTING USA, LLC

410-D Keystone Drive, 15086 Warrendale, PA 15086 - Phone: +1 724 742 0030
customersupport.usa@we-ef.com - <https://we-ef.com/us>
Subject to technical changes and errors. - Generated on 11/23/2024

Mounting Accessories

Wall and pole brackets RE

Description	Part ID	C1	D1	D2	D × L1	H1	M1	Weight (lb)	C	H
RE0-540 Wall bracket	111-0084	7.09	9.06	7.68			0.47	7.05	140	

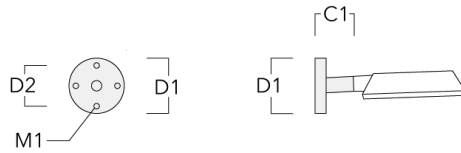

RE1-540 Pole bracket, single	111-0042	7.87			3 x 5	21.65		10.14	200	550
------------------------------	----------	------	--	--	-------	-------	--	-------	-----	-----

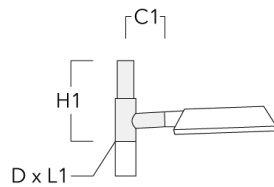

RFL540-SE LED

Description	Part ID	C1	D1	D2	D × L1	H1	M1	Weight (lb)	C	H
RE2-540 Pole bracket, double	111-0043	7.87			3 x 5	21.65		11.68	200	550

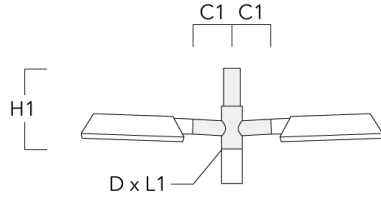

Pole brackets RF

Description	Part ID	C1	D × L1	H1	Weight (lb)	C	H
RF1-540 Pole bracket, single	111-0046	7.87	3 x 3	7.87	5.73	200	300

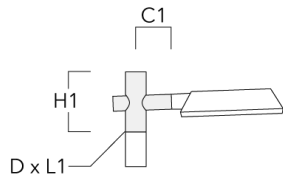

WE-EF LIGHTING USA, LLC

410-D Keystone Drive, 15086 Warrendale, PA 15086 - Phone: +1 724 742 0030

customersupport.usa@we-ef.com - <https://we-ef.com/us>

Subject to technical changes and errors. - Generated on 11/23/2024

RFL540-SE LED

Description	Part ID	C1	D × L1	H1	Weight (lb)	C	H
RF2-540 Pole bracket, double	111-0047	7.87	2.99 x 3.15	7.87	7.28	200	300

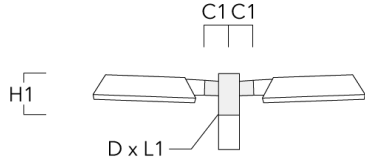

Wall and pole brackets RI

Description	Part ID	C1	D × L1	H1	Weight (lb)
R11-540 Adjustable pole bracket, single	111-0179	7.87"	3 x 3	20.67"	12.00 lbs

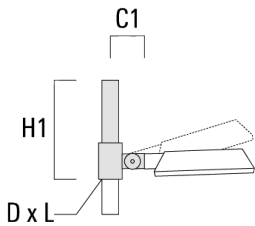

WE-EF LIGHTING USA, LLC

410-D Keystone Drive, 15086 Warrendale, PA 15086 - Phone: +1 724 742 0030

customersupport.usa@we-ef.com - <https://we-ef.com/us>

Subject to technical changes and errors. - Generated on 11/23/2024

RFL540-SE LED

Description	Part ID	C1	D × L1	H1	Weight (lb)
R12-540 Adjustable pole bracket, double	106-0481	7.87"	3 x 3	20.67"	14.00 lbs

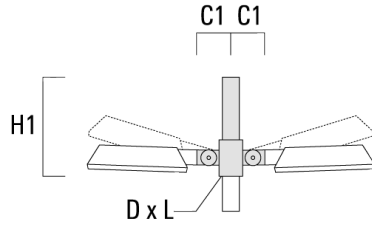

Wall and pole brackets RX

Description	Part ID	C1	D1	D2	D × L1	H1	H2	M1	M2	Weight (lb)
RX0-540 Wall bracket	111-0086	39.37	5.51	3.94		17.72	15.16	1.18	0.47	11.46

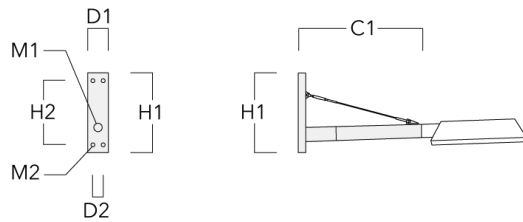

WE-EF LIGHTING USA, LLC

410-D Keystone Drive, 15086 Warrendale, PA 15086 - Phone: +1 724 742 0030

customersupport.usa@we-ef.com - <https://we-ef.com/us>

Subject to technical changes and errors. - Generated on 11/23/2024

RFL540-SE LED

Description	Part ID	C1	D1	D2	D x L1	H1	H2	M1	M2	Weight (lb)
RX1-540 Pole bracket, single	111-0054	39.37			2.99 x 3.15	21.65				14.99

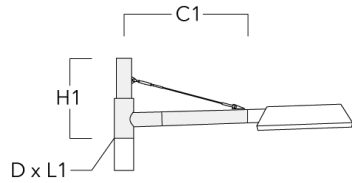

RX2-540 Pole bracket, double	111-0055	39.37			2.99 x 3.15	21.65				21.38
------------------------------	----------	-------	--	--	-------------	-------	--	--	--	-------

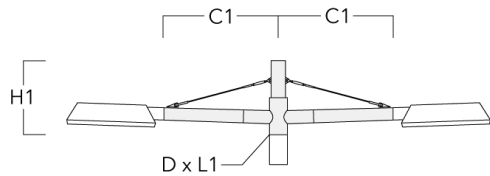

WE-EF LIGHTING USA, LLC

410-D Keystone Drive, 15086 Warrendale, PA 15086 - Phone: +1 724 742 0030
 customersupport.usa@we-ef.com - <https://we-ef.com/us>
 Subject to technical changes and errors. - Generated on 11/23/2024

111-0422

we-ef

RFL540-SE LED

Tilt brackets TB

Description	Part ID	A	D1	D2	L	Weight (lb)
TB-540.60-10 Tilt bracket 10°	111-0636	10°	2.36 x 3.54	2.36 x 3.94	205	1.54

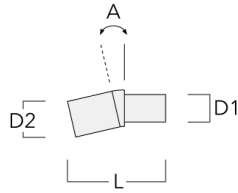

TB-540.60-15 Tilt bracket 15°	111-0637	15°	2.36 x 3.54	2.36 x 3.94	205	1.54
-------------------------------	----------	-----	-------------	-------------	-----	------

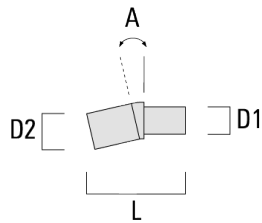

WE-EF LIGHTING USA, LLC

410-D Keystone Drive, 15086 Warrendale, PA 15086 - Phone: +1 724 742 0030
customersupport.usa@we-ef.com - <https://we-ef.com/us>
Subject to technical changes and errors. - Generated on 11/23/2024

111-0422

we-ef

RFL540-SE LED

Pole clamp SI

Description	Part ID	C1	D1	Weight (lb)	C	D
SI2-540 Pole clamp, double (Ø 3"-3.5")	111-0072	7.68"	3.0"-3.5"	195	76 - 89	

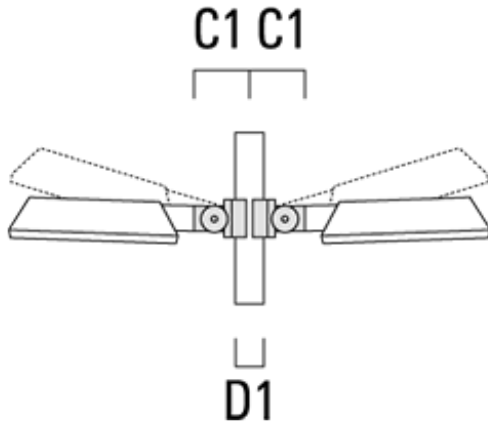

SI2-540 Pole clamp, double (Ø 4.5"-5.25")	111-0073	7.68"	4.5"-5.25"	14 lbs	195	102 - 114
---	----------	-------	------------	--------	-----	-----------

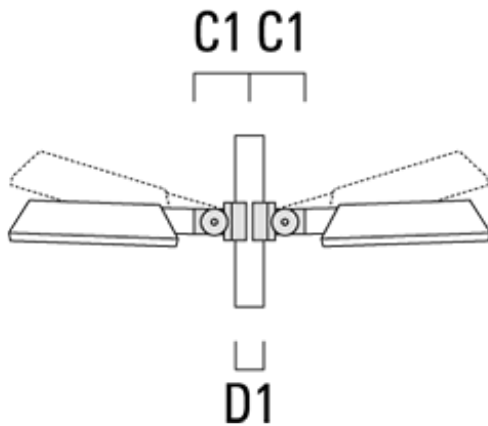

WE-EF LIGHTING USA, LLC

410-D Keystone Drive, 15086 Warrendale, PA 15086 - Phone: +1 724 742 0030
customersupport.usa@we-ef.com - <https://we-ef.com/us>

Subject to technical changes and errors. - Generated on 11/23/2024

RFL540-SE LED

Description	Part ID	C1	D1	Weight (lb)	C	D
S11-540 Pole clamp, single (Ø 3"-3.5")	111-0070	7.68	3.0-3.50	11.00	195	76 - 89

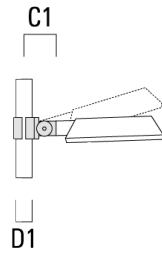

S11-540 Pole clamp, single (Ø 4.5"-5.25")	111-0071	7.68"	4.50"-5.25"	14.00 lbs	195	102 - 114
---	----------	-------	-------------	-----------	-----	-----------

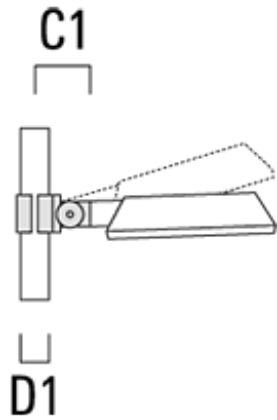

WE-EF LIGHTING USA, LLC

410-D Keystone Drive, 15086 Warrendale, PA 15086 - Phone: +1 724 742 0030
 customersupport.usa@we-ef.com - <https://we-ef.com/us>
 Subject to technical changes and errors. - Generated on 11/23/2024

RFL540-SE LED

Description	Part ID	C1	D1	Weight (lb)	C	D
S11-540 Pole clamp, single (Ø 4"-4.5")	111-0177	7.68"	4.0"-4.5"	12.00 lbs	195	102 - 114

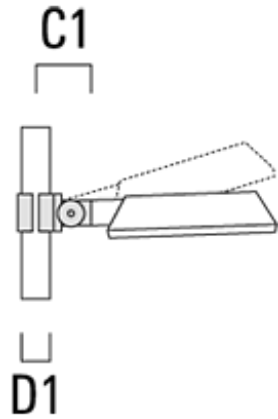

S12-540 Pole clamp, double (Ø 4"-4.5")	111-0183	7.68"	4.0"-4.5"	12 lbs	195	102 - 114
--	----------	-------	-----------	--------	-----	-----------

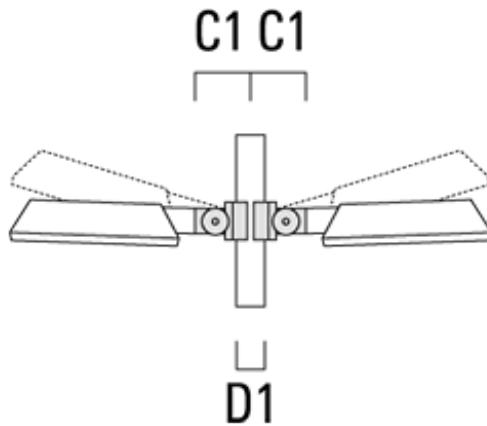

WE-EF LIGHTING USA, LLC

410-D Keystone Drive, 15086 Warrendale, PA 15086 - Phone: +1 724 742 0030
 customersupport.usa@we-ef.com - <https://we-ef.com/us>
 Subject to technical changes and errors. - Generated on 11/23/2024

Optical Accessories**Light shield**

Description	Part ID	Additional information
LS180-[A60]	430-0038	Light shield LS180 to greatly reduce or eliminate light pollution. PA injection moulded component, black matt. Suitable for asymmetric light distribution [A60].
LS180	430-0029	Glare Shield for backlight spill. Glare Shield factory-installed or available as retrofit kit. Suitable for [S60], [S65], [S70], [R65], [P65] lenses. Must be specified at time of ordering.

WE-EF LIGHTING USA, LLC

410-D Keystone Drive, 15086 Warrendale, PA 15086 - Phone: +1 724 742 0030
customersupport.usa@we-ef.com - <https://we-ef.com/us>

Subject to technical changes and errors. - Generated on 11/23/2024