

115-1696

ZAT440-FT LED

we-ef



Description

IP66, Class I. Class II on request. IK09. Marine-grade, die-cast aluminium alloy. 5CE superior corrosion protection including PCS hardware. Silicone CCG® Controlled Compression Gasket. PMMA main lens. Integral EC electronic converter in thermally separated compartment. DALI. CAD-optimised indirect optics for superior illumination and glare control. Factory installed LED circuit board. The luminaire is factory-sealed and does not need to be opened during installation.

Weight	7.80 kg
Light distribution	controlled symmetric distribution [C50]
Light source	LED-FT-24W / 700 mA - 4000 K
CRI	80
Power supply	EC
LEDs	1
Rated input power	27 W
Rated lumens (lm)	
LED Lumen	3417.5
Total Lumen	3417.5
Ta	25
Nominal Lumen (lm)	
LED Lumen	4400
Total Lumen	4400
Tc	25

Fagerhult Lighting Ltd

33-34 Dolben Street, SE1 0UQ London, United Kingdom

<https://we-ef.com/uk>

Subject to technical changes and errors. - Generated on 19/04/2025

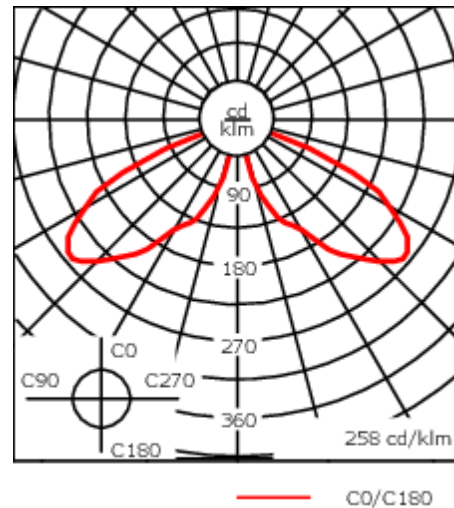

Specifications

Material description

Body	Marine-grade, die-cast aluminium alloy
Lens	PMMA
Colours	<div style="display: flex; align-items: center;"> <div style="width: 20px; height: 15px; background-color: black; margin-right: 5px;"></div> RAL9004 Signal black </div> <div style="display: flex; align-items: center; margin-top: 5px;"> <div style="width: 20px; height: 15px; background-color: #cccccc; margin-right: 5px;"></div> RAL9006 White aluminium </div> <div style="display: flex; align-items: center; margin-top: 5px;"> <div style="width: 20px; height: 15px; background-color: #808080; margin-right: 5px;"></div> RAL9007 Grey aluminium </div> <div style="display: flex; align-items: center; margin-top: 5px;"> <div style="width: 20px; height: 15px; background-color: #333333; margin-right: 5px;"></div> RAL7016 Anthracite grey </div> <div style="display: flex; align-items: center; margin-top: 5px;"> <div style="width: 20px; height: 15px; background-color: #e0e0e0; margin-right: 5px;"></div> RAL9016 Traffic white </div>
Gasket	Silicone CCG® Controlled Compression Gasket
Fasteners	PCS Polymer Coated Stainless Steel Hardware
Ingress protection	IP66
Impact resistance	IK09
Corrosion resistance	5CE
Windage	0.160 m ²

Electrical description

Power supply	220-240V / 50-60 Hz
Driver / Ballast	Integral EC electronic converter. DALI
Power factor	> 0.9
Surge protection	6/6 kV (optional SP10)

Fagerhult Lighting Ltd

33-34 Dolben Street, SE1 0UQ London, United Kingdom

<https://we-ef.com/uk>

Subject to technical changes and errors. - Generated on 19/04/2025

115-1696

ZAT440-FT LED

we-ef

Additional information

Lifetime Ta=25° L70B50 > 50000h

Energy efficiency class C-D (Light source)

115-1696

ZAT440-FT LED

we-ef

Optical Accessories

Light shield

Description	Part ID	H1
LS180-[C60]	159-0321	120



Mounting Accessories

Wall and pole brackets RZ

Description	Part ID	C1	D1	D2	D × L1	M1	Weight (kg)
RZ0-400 Wall bracket, single	115-1324	277	231	195	76 x 80	12	3.50



RZ2-400 Pole bracket, double	115-1323	258			76 x 100		4.90
------------------------------	----------	-----	--	--	----------	--	------

