

115-1731

ZAT460-FT LED

we-ef



Description

IP66, Class I. IK08. Marine-grade, die-cast aluminium alloy. 5CE superior corrosion protection including PCS hardware. PMMA main lens. Silicone CCG® Controlled Compression Gasket. Luminaire is factory-sealed and does not need to be opened during installation.

Integral electronic converter with DALI interface in thermally separated compartment. CAD-optimised indirect optics for superior illumination and glare control. Factory installed LED circuit board.

Including 0.5 m cable with a cable connector.

Weight	9.70 kg
Light distribution	controlled symmetric distribution [C50]
Light source	LED-FT-24W / 700 mA - 3000 K
CRI	80
Power supply	EC
BUG	B2 U2 G1
LEDs	1
Rated input power	27 W
Rated lumens (lm)	
LED Lumen	3218.9
Total Lumen	3218.9
Ta	25
Nominal Lumen (lm)	
LED Lumen	4220
Total Lumen	4220
Tc	25

WE-EF LIGHTING (Thailand) Co., Ltd.

57 Moo 5, Kingkaew Rd., Bangplee, 10540 Samutprakarn - Phone: +66 2 738 96 20 - Fax: +66 2 738 96 29

<https://we-ef.com/asia>

Subject to technical changes and errors. - Generated on 23/11/2024

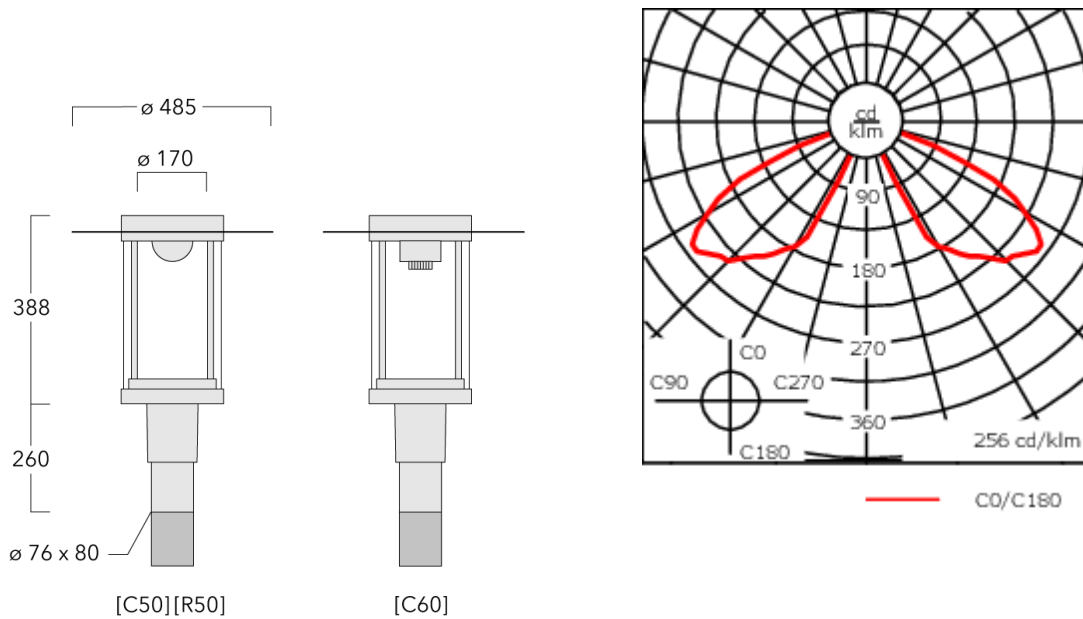

Specifications

Material description

Body	Marine-grade, die-cast aluminium alloy
Lens	PMMA
Colours	<div style="display: flex; align-items: center;"> <div style="width: 20px; height: 15px; background-color: black; margin-right: 5px;"></div> RAL9004 Signal black </div> <div style="display: flex; align-items: center; margin-top: 5px;"> <div style="width: 20px; height: 15px; background-color: grey; margin-right: 5px;"></div> RAL9007 Grey aluminium </div> <div style="display: flex; align-items: center; margin-top: 5px;"> <div style="width: 20px; height: 15px; background-color: darkgrey; margin-right: 5px;"></div> RAL7016 Anthracite grey </div> <div style="display: flex; align-items: center; margin-top: 5px;"> <div style="width: 20px; height: 15px; background-color: white; margin-right: 5px;"></div> RAL9016 Traffic white </div>
Gasket	Silicone CCG® Controlled Compression Gasket
Fasteners	PCS Polymer Coated Stainless Steel Hardware
Ingress protection	IP66
Impact resistance	IK08
Corrosion resistance	5CE
Windage	0.190 m ²

Electrical description

Driver / Ballast	Integral electronic converter with DALI interface in thermally separated compartment
Power factor	> 0.9

Additional information

Lifetime	Ta=25° L70B50 > 50000h
BUG Rating	Please see individual Spec Sheets for classification of Backlight, Uplight and Glare

115-1731

ZAT460-FT LED

we-ef

Optical Accessories

Light shield

Description	Part ID	H1
Cut-off shield IL-180	159-0321	120

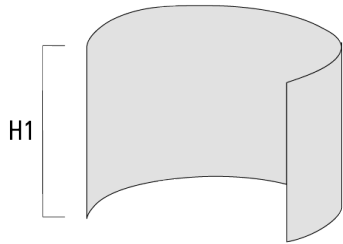

Mounting Accessories

Wall and pole brackets RZ

Description	Part ID	C1	D1	D2	D × L1	M1	Weight (kg)
Wall bracket RZO-400, single	115-1324	277	231	195	76 x 80	12	3.50



Pole bracket RZ2-400, double	115-1323	258			76 x 100		4.90
------------------------------	----------	-----	--	--	----------	--	------

