

115-1675

ZAT430 LED

we-ef



Description

IP66, Class I. IK09. Marine-grade, die-cast aluminium alloy. 5CE superior corrosion protection including PCS hardware. PMMA main lens. Silicone CCG® Controlled Compression Gasket. Luminaire is factory-sealed and does not need to be opened during installation.

Integral electronic converter with DALI interface in thermally separated compartment. CAD-optimised indirect optics for superior illumination and glare control. Factory installed LED circuit board. Optional 2200 K version available. To be specified at time of ordering.

Including 0.5 m cable with a cable connector.

Weight	7.80 kg
Light distribution	rectangular, side throw [R65]
Light source	LED-9/18W / 700 mA - 4000 K
CRI	80
Power supply	EC
BUG	B1 U2 G1
LEDs	9
Rated input power	20 W

Nominal Lumen (lm)

LED Lumen	310
Total Lumen	2790
Tj	85

Rated lumens (lm)

LED Lumen	237.4
Total Lumen	2136.3
Ta	25

WE-EF LIGHTING (Thailand) Co., Ltd.

57 Moo 5, Kingkaew Rd., Bangplee, 10540 Samutprakarn - Phone: +66 2 738 96 20 - Fax: +66 2 738 96 29

<https://we-ef.com/asia>

Subject to technical changes and errors. - Generated on 23/11/2024

115-1675



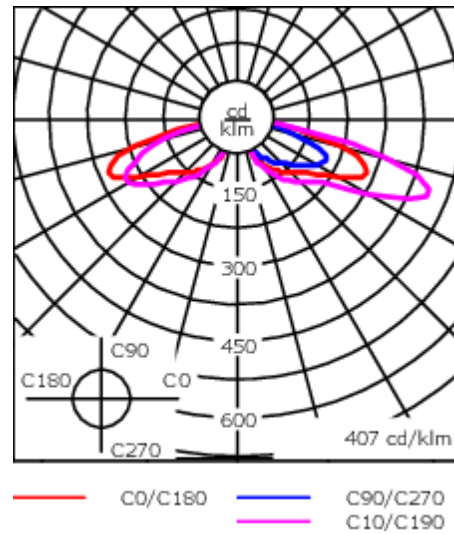
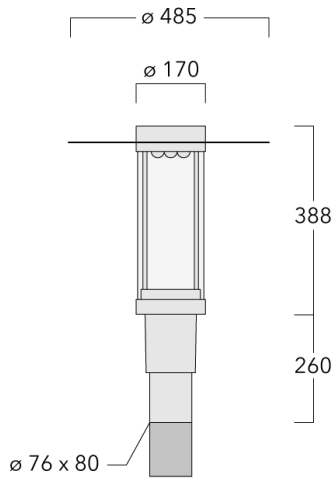

ZAT430 LED

we-ef



Specifications

Material description

Body	Marine-grade, die-cast aluminium alloy
Lens	PMMA
Colours	 RAL9004 Signal black  RAL9007 Grey aluminium  RAL7016 Anthracite grey  RAL9016 Traffic white
Gasket	Silicone CCG® Controlled Compression Gasket
Fasteners	PCS Polymer Coated Stainless Steel Hardware
Ingress protection	IP66
Impact resistance	IK09
Corrosion resistance	5CE
Windage	0.130 m ²

Electrical description

Driver / Ballast	Integral electronic converter with DALI interface in thermally separated compartment
Power factor	> 0.9

Additional information

Lifetime	Ta=25° L90B10 > 90000h
BUG Rating	Please see individual Spec Sheets for classification of Backlight, Uplight and Glare

WE-EF LIGHTING (Thailand) Co., Ltd.

57 Moo 5, Kingkaew Rd., Bangplee, 10540 Samutprakarn - Phone: +66 2 738 96 20 - Fax: +66 2 738 96 29

<https://we-ef.com/asia>

Subject to technical changes and errors. - Generated on 23/11/2024

Mounting Accessories

Wall and pole brackets RZ

Description	Part ID	C1	D1	D2	D × L1	M1	Weight (kg)
Wall bracket RZO-400, single	115-1324	277	231	195	76 x 80	12	3.50

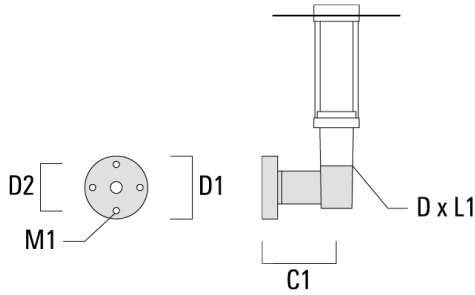

Pole bracket RZ2-400, double	115-1323	258			76 x 100	4.90	
------------------------------	----------	-----	--	--	----------	------	--

