

115-1729

ZAT440 LED

we-ef



Description

IP66, Class I. Class II on request. IK09. Marine-grade, die-cast aluminium alloy. 5CE superior corrosion protection including PCS hardware. Silicone CCG® Controlled Compression Gasket. PMMA main lens. Integral EC electronic converter in thermally separated compartment. DALI. CAD-optimised OLC® One LED Concept optics for superior illumination and glare control. Factory installed LED circuit board. The luminaire is factory-sealed and does not need to be opened during installation.

Optional 2200 K version available. To be specified at time of ordering.

Weight	7.90 kg
Light distribution	asymmetric, side throw beam [S65]
Light source	LED-9/27W / 1050 mA - 4000 K
CRI	80
Power supply	EC
LEDs	9
Rated input power	30 W
Nominal Lumen (lm)	
LED Lumen	450
Total Lumen	4050
T _j	85
Rated lumens (lm)	
LED Lumen	344.9
Total Lumen	3104.5
T _a	25

Fagerhult Lighting Ltd

33-34 Dolben Street, SE1 0UQ London, United Kingdom

<https://we-ef.com/uk>

Subject to technical changes and errors. - Generated on 23/11/2024

115-1729



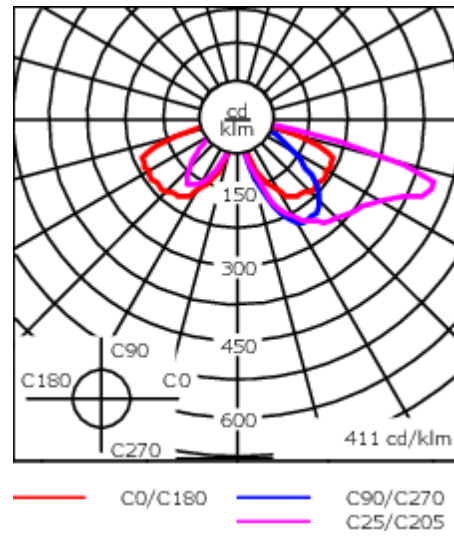
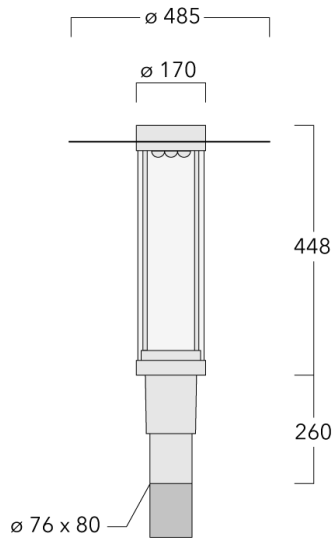

ZAT440 LED

we-ef



Specifications

Material description

Body	Marine-grade, die-cast aluminium alloy
Lens	PMMA
Colours	 RAL9004 Signal black  RAL9006 White aluminium  RAL9007 Grey aluminium  RAL7016 Anthracite grey  RAL9016 Traffic white
Gasket	Silicone CCG® Controlled Compression Gasket
Fasteners	PCS Polymer Coated Stainless Steel Hardware
Ingress protection	IP66
Impact resistance	IK09
Corrosion resistance	5CE
Windage	0.160 m ²

Electrical description

Power supply	220-240V / 50-60 Hz
Driver / Ballast	Integral EC electronic converter. DALI
Power factor	> 0.9
Surge protection	6/6 kV (optional SP10)

Fagerhult Lighting Ltd

33-34 Dolben Street, SE1 0UQ London, United Kingdom

<https://we-ef.com/uk>

Subject to technical changes and errors. - Generated on 23/11/2024

115-1729

ZAT440 LED

we-ef

Additional information

Lifetime Ta=25° L90B10 > 90000h

Energy efficiency class C-D (Light source)

Mounting Accessories

Wall and pole brackets RZ

Description	Part ID	C1	D1	D2	D × L1	M1	Weight (kg)
RZ0-400 Wall bracket, single	115-1324	277	231	195	76 x 80	12	3.50



RZ2-400 Pole bracket, double	115-1323	258			76 x 100		4.90
------------------------------	----------	-----	--	--	----------	--	------

