

115-1742

ZAT460 LED

we-ef



Description

IP66, Class I. Class II on request. IK08. Marine-grade, die-cast aluminium alloy. 5CE superior corrosion protection including PCS hardware. Silicone CCG® Controlled Compression Gasket. PMMA main lens. Integral EC electronic converter in thermally separated compartment. DALI. CAD-optimised OLC® One LED Concept optics for superior illumination and glare control. Factory installed LED circuit board. The luminaire is factory-sealed and does not need to be opened during installation.

Optional 2200 K version available. To be specified at time of ordering.

| | |
|--------------------|-------------------------------|
| Weight | 10.50 kg |
| Light distribution | rectangular, side throw [R65] |
| Light source | LED-18/36W / 700 mA - 2700 K |
| CRI | 80 |
| Power supply | EC |
| LEDs | 18 |
| Rated input power | 41 W |

Nominal Lumen (lm)

| | |
|-------------|------|
| LED Lumen | 270 |
| Total Lumen | 4860 |
| Tj | 85 |

Rated lumens (lm)

| | |
|-------------|--------|
| LED Lumen | 214 |
| Total Lumen | 3851.5 |
| Ta | 25 |

WE-EF LEUCHTEN GmbH

Töpinger Straße 16, 29646 Bispingen, Germany - Phone: +49 5194 909-0
info@we-ef.com - <https://we-ef.com>

Subject to technical changes and errors. - Generated on 23/10/2024

115-1742



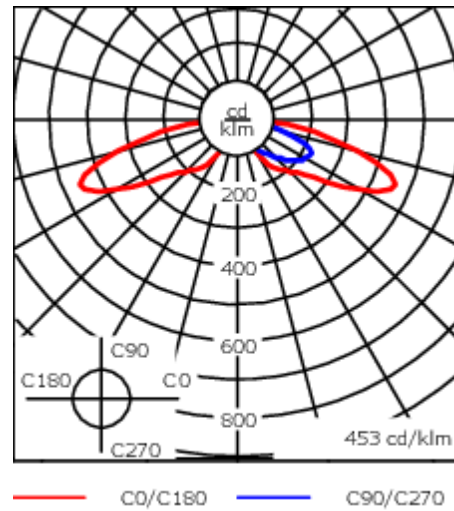
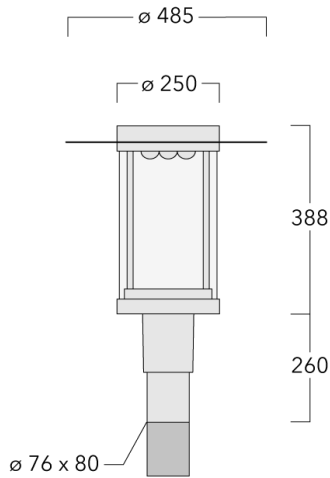

ZAT460 LED

we-ef



Specifications

Material description

| | |
|----------------------|---|
| Body | Marine-grade, die-cast aluminium alloy |
| Lens | PMMA |
| Colours |  RAL9004 Signal black  RAL9006 White aluminium  RAL9007 Grey aluminium  RAL7016 Anthracite grey  RAL9016 Traffic white |
| Gasket | Silicone CCG® Controlled Compression Gasket |
| Fasteners | PCS Polymer Coated Stainless Steel Hardware |
| Ingress protection | IP66 |
| Impact resistance | IK08 |
| Corrosion resistance | 5CE |
| Windage | 0.190 m ² |

Electrical description

| | |
|------------------|--|
| Power supply | 220-240V / 50-60 Hz |
| Driver / Ballast | Integral EC electronic converter. DALI |
| Power factor | > 0.9 |
| Surge protection | 6/6 kV (optional SP10) |

WE-EF LEUCHTEN GmbH

Töpinger Straße 16, 29646 Bispingen, Germany - Phone: +49 5194 909-0

info@we-ef.com - <https://we-ef.com>

Subject to technical changes and errors. - Generated on 23/10/2024

115-1742

ZAT460 LED

we-ef

Additional information

Lifetime Ta=25° L90B10 > 90000h

Energy efficiency class C-D (Light source)

WE-EF LEUCHTEN GmbH

Töpinger Straße 16, 29646 Bispingen, Germany - Phone: +49 5194 909-0

info@we-ef.com - <https://we-ef.com>

Subject to technical changes and errors. - Generated on 23/10/2024

Mounting Accessories

Wall and pole brackets RZ

| Description | Part ID | C1 | D1 | D2 | D x L1 | M1 | Weight (kg) |
|------------------------------|----------|-----|-----|-----|---------|----|-------------|
| RZ0-400 Wall bracket, single | 115-1324 | 277 | 231 | 195 | 76 x 80 | 12 | 3.50 |

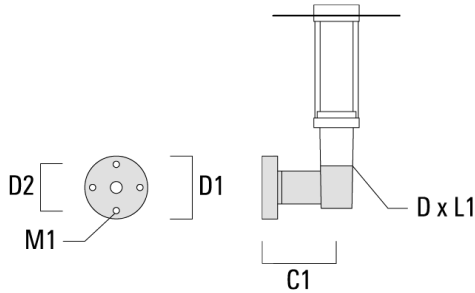

| | | | | | | | |
|------------------------------|----------|-----|--|--|----------|--|------|
| RZ2-400 Pole bracket, double | 115-1323 | 258 | | | 76 x 100 | | 4.90 |
|------------------------------|----------|-----|--|--|----------|--|------|

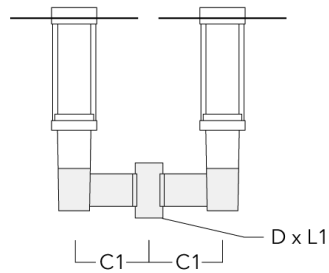

115-1742

ZAT460 LED

WE-EF LEUCHTEN GmbH

Töpinger Straße 16, 29646 Bispingen, Germany

Phone: +49 5194 909-0

info@we-ef.com

<https://we-ef.com>

Subject to technical changes and errors.

Generated on 23/10/2024