

115-1743

ZAT460 LED

**we-ef**



### Description

IP66, Class I. Class II on request. IK08. Marine-grade, die-cast aluminium alloy. 5CE superior corrosion protection including PCS hardware. Silicone CCG® Controlled Compression Gasket. PMMA main lens. Integral EC electronic converter in thermally separated compartment. DALI. CAD-optimised OLC® One LED Concept optics for superior illumination and glare control. Factory installed LED circuit board. The luminaire is factory-sealed and does not need to be opened during installation.

Optional 2200 K version available. To be specified at time of ordering.

|                    |                               |
|--------------------|-------------------------------|
| Weight             | 10.50 kg                      |
| Light distribution | rectangular, side throw [R65] |
| Light source       | LED-18/36W / 700 mA - 3000 K  |
| CRI                | 80                            |
| Power supply       | EC                            |
| LEDs               | 18                            |
| Rated input power  | 41 W                          |

### Nominal Lumen (lm)

|             |      |
|-------------|------|
| LED Lumen   | 290  |
| Total Lumen | 5220 |
| Tj          | 85   |

### Rated lumens (lm)

|             |        |
|-------------|--------|
| LED Lumen   | 229.8  |
| Total Lumen | 4136.8 |
| Ta          | 25     |

### Fagerhult Lighting Ltd

33-34 Dolben Street, SE1 0UQ London, United Kingdom

<https://we-ef.com/uk>

Subject to technical changes and errors. - Generated on 23/11/2024

115-1743



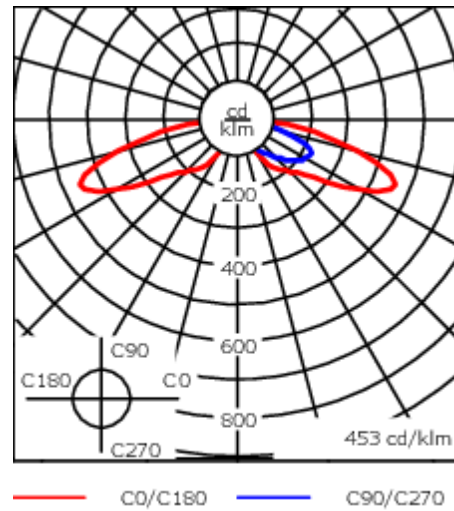
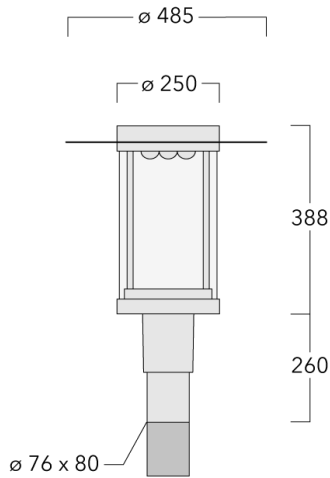

ZAT460 LED

**we-ef**



## Specifications

### Material description

|                      |   |
|----------------------|---|
| Body                 | Marine-grade, die-cast aluminium alloy  |
| Lens                 | PMMA  |
| Colours              | <ul style="list-style-type: none"><li> RAL9004 Signal black</li><li> RAL9006 White aluminium</li><li> RAL9007 Grey aluminium</li><li> RAL7016 Anthracite grey</li><li> RAL9016 Traffic white</li></ul> |
| Gasket               | Silicone CCG® Controlled Compression Gasket   |
| Fasteners            | PCS Polymer Coated Stainless Steel Hardware   |
| Ingress protection   | IP66  |
| Impact resistance    | IK08  |
| Corrosion resistance | 5CE   |
| Windage              | 0.190 m <sup>2</sup>  |

### Electrical description

|                  |  |
|------------------|--|
| Power supply     | 220-240V / 50-60 Hz                    |
| Driver / Ballast | Integral EC electronic converter. DALI |
| Power factor     | > 0.9                                  |
| Surge protection | 6/6 kV (optional SP10)                 |

#### Fagerhult Lighting Ltd

33-34 Dolben Street, SE1 0UQ London, United Kingdom

<https://we-ef.com/uk>

Subject to technical changes and errors. - Generated on 23/11/2024

**115-1743**

**ZAT460 LED**

**we-ef**

**Additional information**

---

Lifetime Ta=25° L90B10 > 90000h

Energy efficiency class C-D (Light source)

---

**Mounting Accessories**

**Wall and pole brackets RZ**

| Description                  | Part ID  | C1  | D1  | D2  | D × L1  | M1 | Weight (kg) |
|------------------------------|----------|-----|-----|-----|---------|----|-------------|
| RZ0-400 Wall bracket, single | 115-1324 | 277 | 231 | 195 | 76 x 80 | 12 | 3.50        |



|                              |          |     |  |  |          |  |      |
|------------------------------|----------|-----|--|--|----------|--|------|
| RZ2-400 Pole bracket, double | 115-1323 | 258 |  |  | 76 x 100 |  | 4.90 |
|------------------------------|----------|-----|--|--|----------|--|------|

