



Description

IP55, Class I. Class II on request. IK10. Marine-grade, die-cast aluminium alloy. 5CE superior corrosion protection including PCS hardware. Silicone rubber gasket. Polycarbonate main lens. Two cable entries. Factory installed LED circuit board. Integral EC electronic converter. Optional 2200 K version available. To be specified at time of ordering.

A pre-installation blackout is available and recommended for mounting in concrete walls. To be ordered separately.

Weight	1.20 kg
Light distribution	diffused distribution
Light source	LED-6/6W / 350 mA - 2700 K
CRI	80
Power supply	EC
LEDs	6
Rated input power	7.5 W
Nominal Lumen (lm)	
LED Lumen	145
Total Lumen	870
Tj	85
Rated lumens (lm)	
LED Lumen	5.8
Total Lumen	35.1
Ta	25

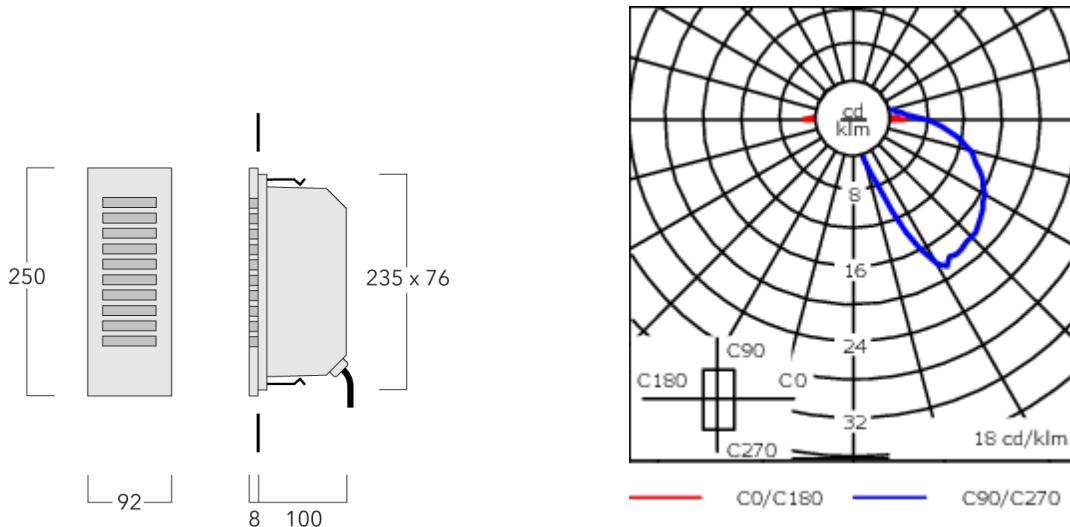

Specifications

Material description

Body	Marine-grade die-cast aluminium alloy
Lens	Polycarbonate lens
Colours	<div style="display: flex; align-items: center;"> <div style="width: 20px; height: 15px; background-color: black; margin-right: 5px;"></div> RAL9004 Signal black </div> <div style="display: flex; align-items: center; margin-top: 5px;"> <div style="width: 20px; height: 15px; background-color: #cccccc; margin-right: 5px;"></div> RAL9006 White aluminium </div> <div style="display: flex; align-items: center; margin-top: 5px;"> <div style="width: 20px; height: 15px; background-color: #808080; margin-right: 5px;"></div> RAL9007 Grey aluminium </div> <div style="display: flex; align-items: center; margin-top: 5px;"> <div style="width: 20px; height: 15px; background-color: #333333; margin-right: 5px;"></div> RAL7016 Anthracite grey </div> <div style="display: flex; align-items: center; margin-top: 5px;"> <div style="width: 20px; height: 15px; background-color: #e0e0e0; margin-right: 5px;"></div> RAL9016 Traffic white </div>
Gasket	Silicone rubber gasket
Fasteners	PCS Polymer Coated Stainless Steel Hardware
Ingress protection	IP55
Impact resistance	IK10
Corrosion resistance	5CE

Electrical description

Power supply	220-240V / 50-60 Hz
Driver / Ballast	Integral EC electronic converter
Surge protection	1/2 kV

Additional information

Lifetime	Ta=25° L80B10 > 54000h
Energy efficiency class	C-D (Light source)

Fagerhult Lighting Ltd

33-34 Dolben Street, SE1 0UQ London, United Kingdom

<https://we-ef.com/uk>

Subject to technical changes and errors. - Generated on 23/11/2024

Mounting Accessories

Installation blackout

Description	Part ID	A	B	C1
Installation blackout BST25-II	133-0078	267	132	140

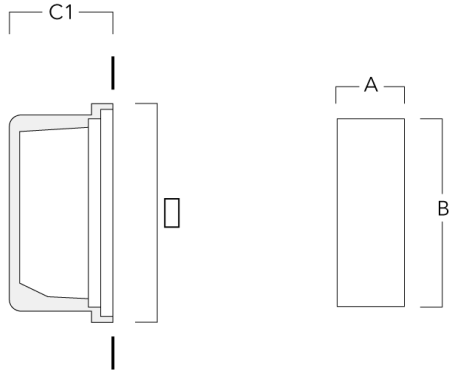

Installation blackout BST25-I	133-0076	267	132	130
-------------------------------	----------	-----	-----	-----

