



Description

IP67*, Class I. IK10+. Stainless steel construction including PCS hardware. Silicone rubber gasket. Safety glass lens; max. load 5 tonnes. Luminaire can be driven over at low speed. Factory-sealed termination chamber complete with cable gland and 1.5 m of flexible PVC free cable. Integral EC electronic converter in thermally separated compartment. 'No tool' removable gear/lens tray. CAD-optimised optics for superior illumination and glare control. OLC® One LED Concept. Factory installed LED circuit board. Gimbal mounted, 360° rotatable and 30° tiltable. Optional 2200 K version available. To be specified at time of ordering.

The optional installation blackout is recommended for mounting. To be ordered separately.

The luminaire is not suitable for permanent underwater operation and must be switched off in the event of flooding.

Optional with Anti-Slip ceramic Coating ASC to DIN 51130 (Trip Classification 10) available on request.

* Additionally tested to IP66, IP67, IP68 0.1 bar 3h, up to 1 m depth according to DIN EN 60598 and IP69K/80° according to DIN EN 60529.

| | |
|--------------------|------------------------------|
| Weight | 5.50 kg |
| Light distribution | symmetric, wide beam [B] |
| Light source | LED-12/12W / 350 mA - 2700 K |
| CRI | 80 |
| Power supply | EC |
| LEDs | 12 |
| Rated input power | 13.9 W |

Nominal Lumen (lm)

| | |
|-------------|------|
| LED Lumen | 145 |
| Total Lumen | 1740 |
| Tj | 85 |

Rated lumens (lm)

| | |
|-------------|--------|
| LED Lumen | 109.6 |
| Total Lumen | 1315.5 |
| Ta | 25 |

WE-EF LEUCHTEN GmbH

Töpinger Straße 16, 29646 Bispingen, Germany - Phone: +49 5194 909-0
info@we-ef.com - <https://we-ef.com>

Subject to technical changes and errors. - Generated on 23/11/2024

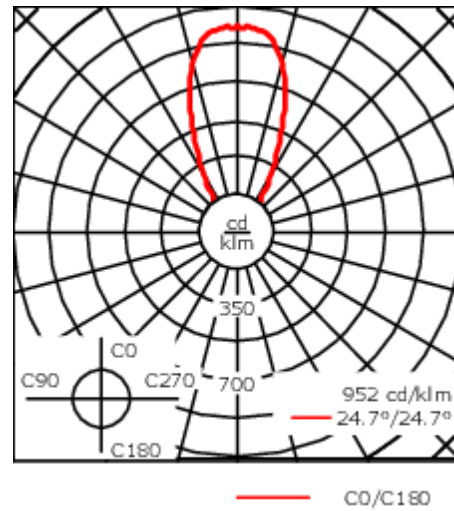
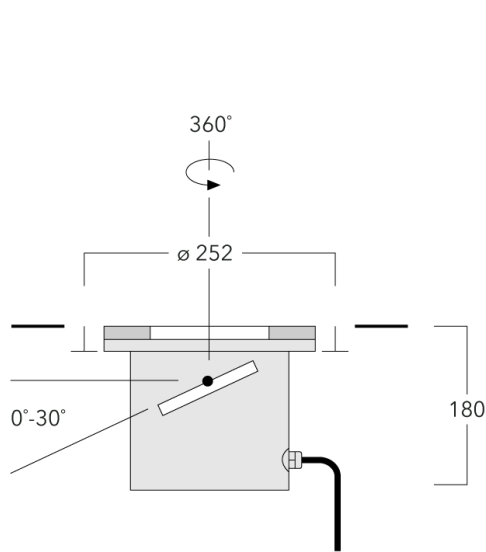

Specifications

Material description

| | |
|--------------------|---|
| Body | Stainless steel construction |
| Lens | Safety glass lens; max. load 5 tonnes |
| Colours |  Stainless Steel |
| Gasket | Silicone rubber gasket |
| Fasteners | PCS Polymer Coated Stainless Steel Hardware |
| Ingress protection | IP67 |
| Impact resistance | IK10+ |

Electrical description

| | |
|------------------|----------------------------------|
| Power supply | 220-240V / 50-60 Hz |
| Driver / Ballast | Integral EC electronic converter |
| Power factor | > 0.9 |
| Surge protection | 1/2 kV |

Additional information

| | |
|-------------------------|------------------------|
| Lifetime | Ta=25° L90B10 > 90000h |
| Energy efficiency class | C-D (Light source) |

Mounting Accessories

Installation cover

| Description | Part ID | C1 |
|-----------------------|----------|-----|
| Installation cover BE | 185-0325 | 250 |

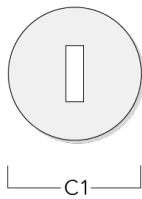

Installation blackout

| Description | Part ID | D1 | D2 | H1 | Weight (kg) | D | H |
|-------------------|----------|-----|-----|-----|-------------|---------|-----|
| Blockout, Plastic | 185-0924 | 250 | 305 | 230 | 1.50 | 250/305 | 230 |

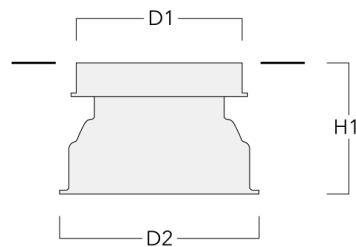

185-3524

ETC330-GB LED

we-ef

Electrical Accessories

Sealable junction box

| Description | Part ID | C1 | M1 | M2 |
|------------------------------|----------|-----|------|-----------|
| Sealable junction box SJB130 | 185-1624 | 146 | Ø 10 | Ø 12 - 19 |

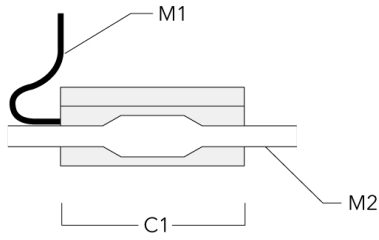

WE-EF LEUCHTEN GmbH

Töpinger Straße 16, 29646 Bispingen, Germany - Phone: +49 5194 909-0
info@we-ef.com - <https://we-ef.com>

Subject to technical changes and errors. - Generated on 23/11/2024

Optical Accessories

Linear spread lens

| Description | Part ID | C1 |
|--------------------------|----------|----|
| IO-180 ETC130/330-GB LED | 185-2632 | 98 |



Flood lens

| Description | Part ID | C1 |
|----------------------|----------|----|
| IO-360-ETC130-GB-LED | 185-2866 | 98 |

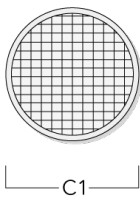

185-3524

ETC330-GB LED

we-ef

Honeycomb louvre

| Description | Part ID | C1 |
|---|----------|----|
| IW-ETC130/330-GB-LED - [M][EE] [EES] | 185-2870 | 98 |

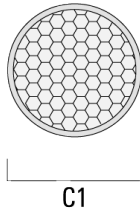

WE-EF LEUCHTEN GmbH

Töpingen Straße 16, 29646 Bispingen, Germany - Phone: +49 5194 909-0
info@we-ef.com - <https://we-ef.com>

Subject to technical changes and errors. - Generated on 23/11/2024