



**Description**

IP69K. Class I. IK10+. Stainless steel construction. PCS hardware. Optional with Anti-Slip ceramic Coating ASC to DIN 51130 (Trip Classification 10) available on request. Silicone CCG® Controlled Compression Gasket. Safety glass lens; max load 5.5 tons (11,000 lbs). Luminaire can be driven over at low speed. Cable gland with spiral cable bending protection. Factory-sealed termination chamber complete with cable gland and 3 ft of flexible PVC-free, gel-impregnated anti-wicking cable. CAD-optimized optics for superior illumination and glare control. Integral driver in thermally separated compartment. OLC® One LED Concept. Factory-installed LED circuit board. 0-10V Dimming comes standard with luminaire. Gimbal mounted, 360° rotatable and 30° tiltable. 'No tool' removable gear/lens tray.

Suitable for flush installation in concrete or earth. The concrete-pour installation blockout is supplied as standard with luminaire.

Specify product with 7 Digit product code - Finish Color. Accessories, such as mounting, optical, and electrical, must be specified separately.

Example: XXX-XXXX-9004 (Black)  
+ XXX-XXXX (Accessory 1)

Weight	18.20 lb
Light distribution	symmetric, very narrow beam [VN]
Light source	LED-12/18W / 500 mA - 2700 K
CRI	80
Power supply	electronic gear
LEDs	12
Rated input power	21 W

**Nominal Lumen (lm)**

LED Lumen	200
Total Lumen	2400
Tj	85

**Rated lumens (lm)**

LED Lumen	163.8
Total Lumen	1966
Ta	25

**WE-EF LIGHTING USA, LLC**

410-D Keystone Drive, 15086 Warrendale, PA 15086 - Phone: +1 724 742 0030  
customersupport.usa@we-ef.com - <https://we-ef.com/us>  
Subject to technical changes and errors. - Generated on 11/23/2024

185-3141

ETC130-GB LED

**we-ef**

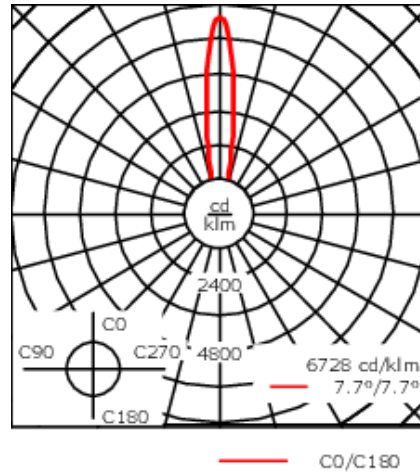
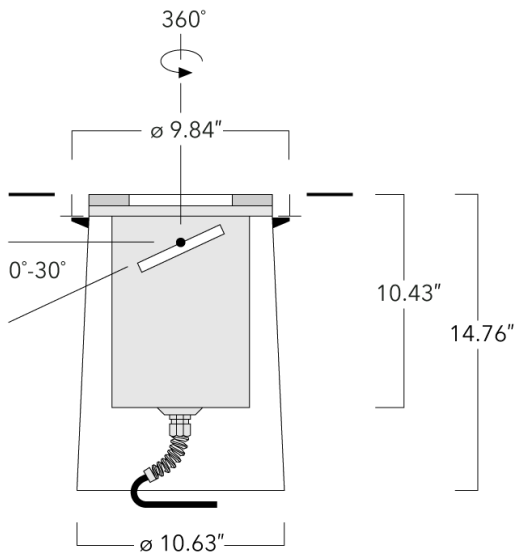

## Specifications

### Material description

Body	Luminaire body constructed of deep drawn stainless steel. Outer housing composite material.
Lens	5/8" thick clear tempered glass lens. Max. load 5000kg/11,000 lbs.
Colors	 Stainless Steel
Gasket	Silicone rubber gasket
Fasteners	PCS polymer coated stainless steel
Ingress protection	IP69K - HIGHEST PROTECTION RATING AVAILABLE
Impact resistance	IK10+
Corrosion resistance	5CE

### Electrical description

Power supply	Integral [ECG] electronic driver 120V-277V. 0-10V dimmable, to be specified with order.
Driver / Ballast	Integral [ECG] electronic driver 120V-277V. 0-10V dimmable, to be specified with order.
Termination	Factory sealed termination chamber
Power factor	> 0.9
Surge protection	Integral 10kV Surge Protector

#### WE-EF LIGHTING USA, LLC

410-D Keystone Drive, 15086 Warrendale, PA 15086 - Phone: +1 724 742 0030

customersupport.usa@we-ef.com - <https://we-ef.com/us>

Subject to technical changes and errors. - Generated on 11/23/2024

**185-3141**

**ETC130-GB LED**

**we-ef**

**Additional information**

---

Lifetime	Ta=25°/40° L90B10 > 90000h
Dimming	0-10V available in request. Must be factory fitted.
Listings	ETL, UL-1598, CSA-C22.2#250.0. Suitable for Wet Locations.

---

**WE-EF LIGHTING USA, LLC**

410-D Keystone Drive, 15086 Warrendale, PA 15086 - Phone: +1 724 742 0030  
customersupport.usa@we-ef.com - <https://we-ef.com/us>  
Subject to technical changes and errors. - Generated on 11/23/2024

185-3141

ETC130-GB LED

**we-ef**

## Electrical Accessories

### Sealable junction box

Description	Part ID	C1	M1	M2
Sealable junction box SJB 130	185-1624	5.75	Ø 0.39	Ø 0.47 - 0.75

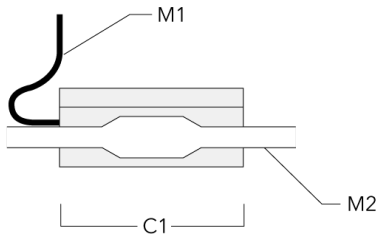

**WE-EF LIGHTING USA, LLC**

410-D Keystone Drive, 15086 Warrendale, PA 15086 - Phone: +1 724 742 0030  
customersupport.usa@we-ef.com - <https://we-ef.com/us>

Subject to technical changes and errors. - Generated on 11/23/2024

**Optical Accessories**

**Linear spread lens**

Description	Part ID	Additional information	C1
IO-180 ETC130/330-GB LED	185-2632		3.94

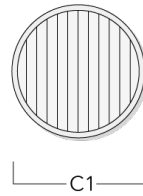

IO-180-DAC120-LED	134-2000	Broadens light distribution in one plane only. Ideally suitable for [M][VN][VNS]. Does not fit in combination with [W] lens. A maximum of one internal optical accessory. Internal component, factory installed.	4.05
-------------------	----------	---	------

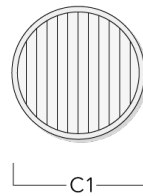

185-3141

**we-ef**

ETC130-GB LED

**Softening Lens**

---

Description	Part ID	C1
I0-360-ETC130-GB-LED	185-2866	3.86

---

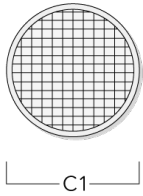

---

**Honeycomb louvre**

---

Description	Part ID	C1
IW-ETC130/330-GB-LED	185-2870	3.86

---

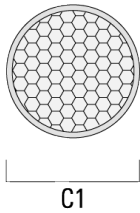

---

**WE-EF LIGHTING USA, LLC**

410-D Keystone Drive, 15086 Warrendale, PA 15086 - Phone: +1 724 742 0030  
customersupport.usa@we-ef.com - <https://we-ef.com/us>  
Subject to technical changes and errors. - Generated on 11/23/2024