

117-0321

ZFY230 LED - 600 mm

we-ef



Description

IP66. IK10. Marine-grade, all-aluminium construction. 5CE superior corrosion protection + primer including PCS hardware. Polycarbonate lens. Silicone CCG_R_C Controlled Compression Gasket. Luminaire is factory-sealed and does not need to be opened during installation.

Integral EC electronic converter in thermally-separated compartment. Advanced thermal management protects LEDs while optimising lumens output. CAD-optimised optics for superior illumination and glare control.

Weight	7.80 kg
Light distribution	symmetric distribution [C60]
Light source	LED-FT-17W / 500 mA - 2700 K
CRI	80
Power supply	EC
LEDs	1
Rated input power	20 W
Rated lumens (lm)	
LED Lumen	1086.2
Total Lumen	1086.2
Ta	25
Nominal Lumen (lm)	
LED Lumen	2935
Total Lumen	2935
Tc	25

WE-EF LIGHTING Pty Ltd

6/13 Downard Street, 3195 Braeside, Victoria - Phone: +61 3 8587 0444 - Fax: +61 3 8587 0499

info.australia@we-ef.com - <https://we-ef.com/aus>

Subject to technical changes and errors. - Generated on 23/11/2024

117-0321

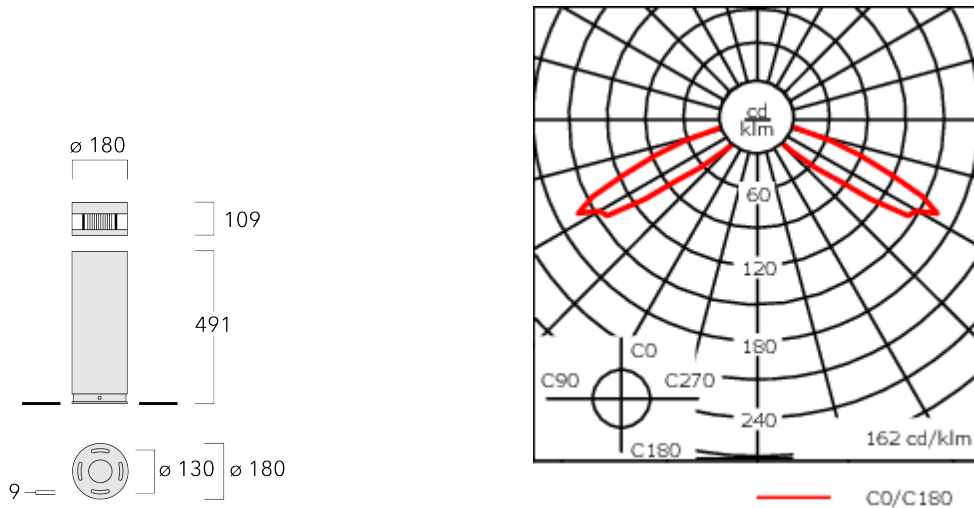

ZFY230 LED - 600 mm

we-ef



Specifications

Material description

Body	Marine-grade, all-aluminium construction
Lens	Polycarbonate lens
Colours	 RAL9004 Signal black  RAL9006 White aluminium  RAL9007 Grey aluminium
Gasket	Silicone CCG® Controlled Compression Gasket
Fasteners	PCS Polymer Coated Stainless Steel Hardware (unpainted)
Ingress protection	IP66
Impact resistance	IK10
Corrosion resistance	5CE+Primer

Electrical description

Power supply	230V / 50 Hz
Driver / Ballast	Integral EC electronic converter
Surge protection	10/10kV (SP10) available on request

Additional information

Lifetime	Ta=40° L70B50 > 50000h
Warranty	The product is supplied with 10-year warranty. Please refer to the LED Warranty Statement located on www.we-ef.com for further details.

WE-EF LIGHTING Pty Ltd

6/13 Downard Street, 3195 Braeside, Victoria - Phone: +61 3 8587 0444 - Fax: +61 3 8587 0499

info.australia@we-ef.com - <https://we-ef.com/aus>

Subject to technical changes and errors. - Generated on 23/11/2024

117-0321

ZFY230 LED - 600 mm

we-ef

Control

1-10 V analogue dimming interface

Description	Part ID	C
1-10 V analogue dimming interface	430-0011	90

WE-EF LIGHTING Pty Ltd

6/13 Downard Street, 3195 Braeside, Victoria - Phone: +61 3 8587 0444 - Fax: +61 3 8587 0499

info.australia@we-ef.com - <https://we-ef.com/aus>

Subject to technical changes and errors. - Generated on 23/11/2024

DALI interface

Description	Part ID	Additional information	C
DALI interface	430-0013	DALI variant. The luminaire is equipped with a DT6 Dali driver (Dali 2.0).	90

Dali 2.0

- Application controllers and Input devices defined
- Single-masters and multi-masters allowed
- Event priorities defined
- Separate addressing & grouping from control gear

Note: Mixing Dali 1 and Dali 2.0 drivers can cause problems because the addressing and the command scope has changed!

117-0321

ZFY230 LED - 600 mm

we-ef

Eco Step Dim® Motion

Description	Part ID
Eco Step Dim® Motion - Linked-Primary	430-0030

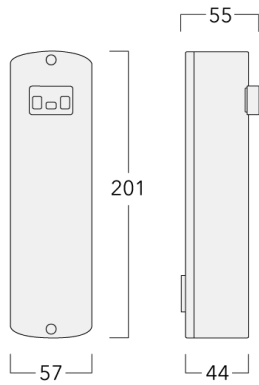

Eco Step Dim® Motion - Linked-Secondary	430-0031
-----------------------------------------	----------

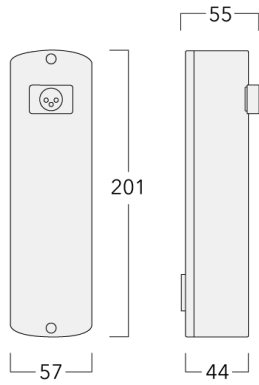

WE-EF LIGHTING Pty Ltd

6/13 Downard Street, 3195 Braeside, Victoria - Phone: +61 3 8587 0444 - Fax: +61 3 8587 0499

info.australia@we-ef.com - <https://we-ef.com/aus>

Subject to technical changes and errors. - Generated on 23/11/2024

117-0321

ZFY230 LED - 600 mm

we-ef

Description	Part ID
Eco Step Dim® Motion - Stand-Alone	430-0037



WE-EF LIGHTING Pty Ltd

6/13 Downard Street, 3195 Braeside, Victoria - Phone: +61 3 8587 0444 - Fax: +61 3 8587 0499

info.australia@we-ef.com - <https://we-ef.com/aus>

Subject to technical changes and errors. - Generated on 23/11/2024

117-0321

ZFY230 LED - 600 mm

we-ef

Mounting Accessories

Planted root

Description	Part ID	D1	D2	D3	D4	H1	H2	M1	T1	T2	Weight (kg)
Planted root ESV4	300-0461-AP	150	130	60	89	400	350	8	200	50 x 100	3.85

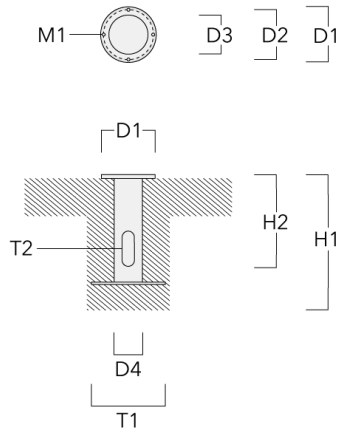

117-0321

ZFY230 LED - 600 mm

we-ef

Optical Accessories

Light shield

Description	Part ID	H1	Weight (kg)
LS180 ZFY	117-0228	49	0.03

