

117-0325

ZFY250 LED-FT I

we-ef



Description

IP66. Class I. IK10. Marine-grade, all aluminum construction. 5CE superior corrosion protection including PCS hardware. Silicone CCG® Controlled Compression Gasket. Polycarbonate main lens. CAD-optimized indirect optics for superior illumination and glare control. Integral driver in thermally separated compartment. Factory-installed LED circuit board. 0-10V Dimming comes standard with luminaire.

Pre-wired post complete with cable connecting box and fuse for mains connection.

Specify product with 7 Digit product code - Finish Color. Accessories, such as mounting, optical, and electrical, must be specified separately.

Example: XXX-XXXX-9004 (Black)
+ XXX-XXXX (Accessory 1)

Weight	26.46 lb
Light distribution	symmetric distribution [C60]
Light source	LED-FT-24W (2700K)
CRI	80
Power supply	electronic gear
LEDs	1
Rated input power	27 W

Rated lumens (lm)

LED Lumen	1000.3
Total Lumen	1000.3
Ta	25

Nominal Lumen (lm)

LED Lumen	4050
Total Lumen	4050
Tc	25

WE-EF LIGHTING USA, LLC

410-D Keystone Drive, 15086 Warrendale, PA 15086 - Phone: +1 724 742 0030
customersupport.usa@we-ef.com - <https://we-ef.com/us>
Subject to technical changes and errors. - Generated on 11/23/2024

117-0325

ZFY250 LED-FT I

we-ef

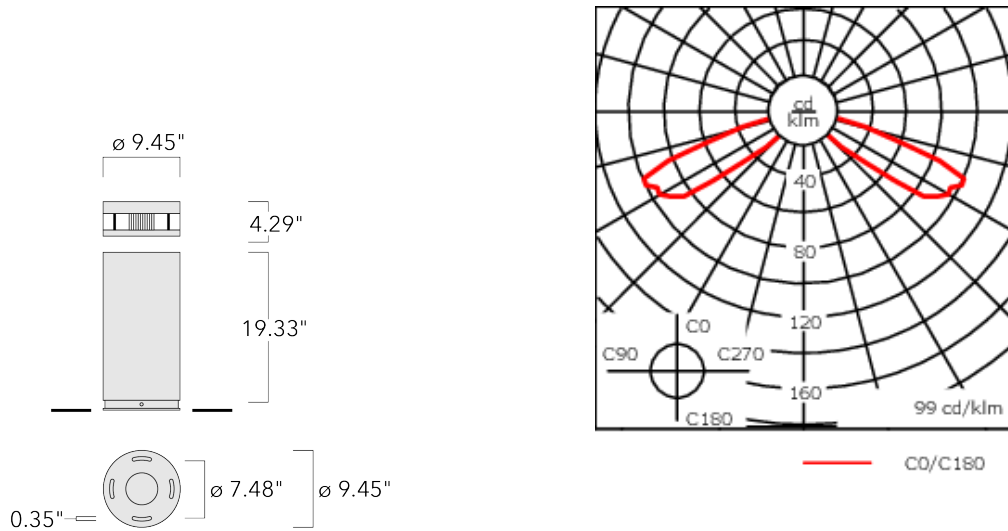

Specifications

Material description

Body	Marine-grade all-aluminium construction
Lens	Polycarbonate
Colors	<div style="display: flex; flex-direction: column; gap: 5px;"> <div style="display: flex; align-items: center;"> <div style="width: 20px; height: 15px; background-color: black; margin-right: 5px;"></div> RAL9004 Black </div> <div style="display: flex; align-items: center;"> <div style="width: 20px; height: 15px; background-color: grey; margin-right: 5px;"></div> RAL9007 Grey Metallic </div> <div style="display: flex; align-items: center;"> <div style="width: 20px; height: 15px; background-color: white; margin-right: 5px;"></div> RAL9016 White </div> <div style="display: flex; align-items: center;"> <div style="width: 20px; height: 15px; background-color: darkgrey; margin-right: 5px;"></div> RAL8019 Dark Bronze </div> </div>
Gasket	Silicone CCG® Controlled Compression Gasket
Fasteners	PCS Polymer Coated Stainless Steel Hardware
Ingress protection	IP66
Impact resistance	IK10
Corrosion resistance	5CE

Electrical description

Power supply	Integral [ECG] electronic driver 120V-277V. 0-10V dimmable, to be specified with order.
Driver / Ballast	Integral EC electronic converter
Surge protection	Integral 10kV Surge Protector

WE-EF LIGHTING USA, LLC

410-D Keystone Drive, 15086 Warrendale, PA 15086 - Phone: +1 724 742 0030

customersupport.usa@we-ef.com - <https://we-ef.com/us>

Subject to technical changes and errors. - Generated on 11/23/2024

117-0325

we-ef

ZFY250 LED-FT I

Additional information

Lifetime Ta=25°/40° L70B50 > 50000h

Listings ETL, UL-1598, CSA-C22.2#250.0. Suitable for Wet Locations.

WE-EF LIGHTING USA, LLC

410-D Keystone Drive, 15086 Warrendale, PA 15086 - Phone: +1 724 742 0030
customersupport.usa@we-ef.com - <https://we-ef.com/us>

Subject to technical changes and errors. - Generated on 11/23/2024

Mounting Accessories

Planted root

Description	Part ID	D1	D2	D3	D4	H1	H2	M1	M2	Weight (lb)
Planted root ESV4	300-0464	8.66	7.48	4.25	4.02	15.75	13.78	.35	.24	9.48

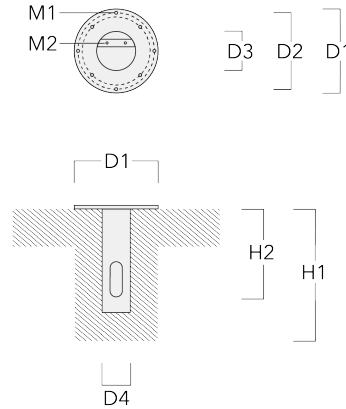

Security Bollard Kits

Description	Part ID	Additional information
SC40 ZFY250 Security Bollard Kit	117-6004	Modification for SC40 Impact Rating; Small Car (2,430 lbs) at 40 MPH; With Impact modifications, height is 39.37"
PU40 ZFY250 Security Bollard Kit	117-6005	Modification for PU40 Impact Rating; Pickup Truck (5,070 lbs) at 40 MPH; With Impact modifications, height is 39.37"
M30 ZFY250 Security Bollard Kit	117-6006	Modification for M30 Impact Rating; Truck (15,000 lbs) at 30 MPH; With Impact modifications, height is 45.02"
M30 Shallow ZFY250 Security Bollard Kit	117-6007	Shallow modification for M30 Impact Rating; Truck (15,000 lbs) at 30 MPH; With Impact modifications, height is 45.02"; Burial depth of 12"

WE-EF LIGHTING USA, LLC

410-D Keystone Drive, 15086 Warrendale, PA 15086 - Phone: +1 724 742 0030

customersupport.usa@we-ef.com - <https://we-ef.com/us>

Subject to technical changes and errors. - Generated on 11/23/2024

117-0325

we-ef

ZFY250 LED-FT I

Optical Accessories

Light shield

Description	Part ID	H1	Weight (lb)
LS180 ZFY	117-0228	1.93	0.07

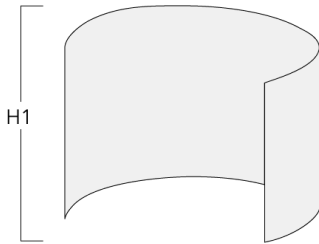

WE-EF LIGHTING USA, LLC

410-D Keystone Drive, 15086 Warrendale, PA 15086 - Phone: +1 724 742 0030
customersupport.usa@we-ef.com - <https://we-ef.com/us>

Subject to technical changes and errors. - Generated on 11/23/2024