



### Description

IP66, Class I. Class II on request. IK10. Marine-grade, all aluminium construction. 5CE superior corrosion protection including PCS hardware. Silicone CCG® Controlled Compression Gasket. Polycarbonate main lens. Integral EC electronic converter in thermally-separated compartment. CAD-optimised indirect optics for superior illumination and glare control. Factory installed LED circuit board. Pre-wired post complete with cable connecting box and fuse for mains connection.

Optional Eco Step Dim® Motion version available. To be specified at time of ordering.

Weight	14.70 kg
Light distribution	symmetric distribution [C60]
Light source	LED-FT-17W / 500 mA - 2700 K
CRI	80
Power supply	EC
LEDs	1
Rated input power	20 W
<b>Rated lumens (lm)</b>	
LED Lumen	724.9
Total Lumen	724.9
Ta	25
<b>Nominal Lumen (lm)</b>	
LED Lumen	2935
Total Lumen	2935
Tc	25

## ZFY250 LED-FT

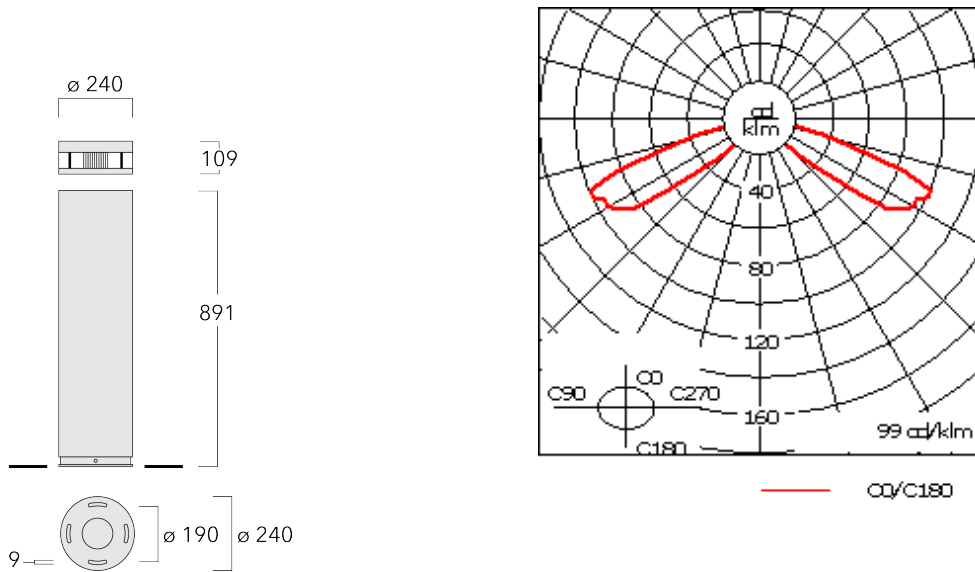

## Specifications

### Material description

Body	Marine-grade all-aluminium construction
Lens	Polycarbonate
Colours	<div style="display: flex; align-items: center;"> <div style="width: 20px; height: 20px; background-color: black; margin-right: 5px;"></div> <div>RAL9004 Signal black</div> </div> <div style="display: flex; align-items: center; margin-top: 5px;"> <div style="width: 20px; height: 20px; background-color: #cccccc; margin-right: 5px;"></div> <div>RAL9006 White aluminium</div> </div> <div style="display: flex; align-items: center; margin-top: 5px;"> <div style="width: 20px; height: 20px; background-color: #808080; margin-right: 5px;"></div> <div>RAL9007 Grey aluminium</div> </div> <div style="display: flex; align-items: center; margin-top: 5px;"> <div style="width: 20px; height: 20px; background-color: #333333; margin-right: 5px;"></div> <div>RAL7016 Anthracite grey</div> </div> <div style="display: flex; align-items: center; margin-top: 5px;"> <div style="width: 20px; height: 20px; background-color: #e0e0e0; margin-right: 5px;"></div> <div>RAL9016 Traffic white</div> </div>
Gasket	Silicone CCG® Controlled Compression Gasket
Fasteners	PCS Polymer Coated Stainless Steel Hardware
Ingress protection	IP66
Impact resistance	IK10
Corrosion resistance	5CE

### Electrical description

Power supply	220-240V / 50-60 Hz
Driver / Ballast	Standard. Optional DALI version available. To be specified at time of ordering.
Power factor	> 0.9
Surge protection	10/10kV (SP10)

**Additional information**

---

Lifetime Ta=25° L70B50 > 50000h

Energy efficiency class D-E (Light source)

---

**Mounting Accessories**

**Planted root**

Description	Part ID	D1	D2	D3	D4	H1	H2	M1	M2	Weight (kg)
Planted root ESV4	300-0464	220	190	102	108	400	350	8	6	4.30

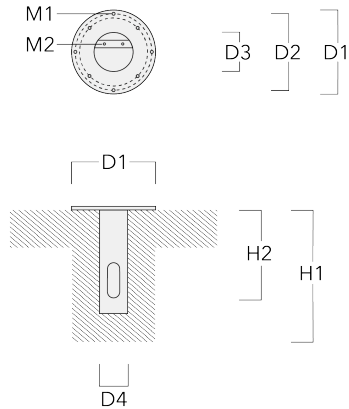

## Optical Accessories

### Light shield

Description	Part ID	H1	Weight (kg)
LS180 ZFY	117-0228	49	0.03

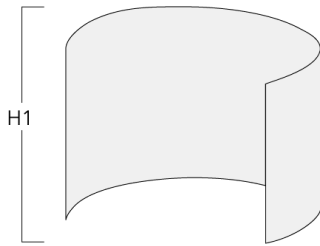

**Control**

**Eco Step Dim® Motion**

Description	Part ID
Eco Step Dim® Motion - Linked-Primary	430-0030

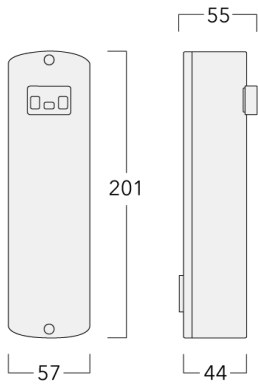

Eco Step Dim® Motion - Linked-Secondary	430-0031
---	----------

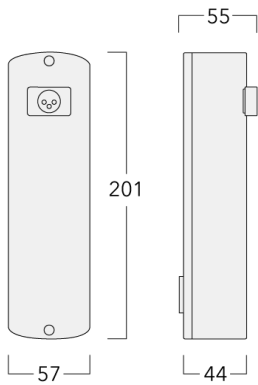

**ZFY250 LED-FT**

---

Description	Part ID
Eco Step Dim® Motion - Stand-Alone	430-0037

---

